

# 1xEV-DO Guide

## Agilent Technologies PSA Series and VSA E4406A

### Option 204

**This manual provides documentation  
for the following instruments:**

**Transmitter Tester:  
E4406A**

**Spectrum Analyzers:  
E4440A (3 Hz - 26.5 GHz)  
E4443A (3 Hz - 6.7 GHz)  
E4445A (3 Hz - 13.2 GHz)  
E4446A (3 Hz - 44.0 GHz)  
E4447A (3 Hz - 42.98 GHz)  
E4448A (3 Hz - 50.0 GHz)**



**Agilent Technologies**

**Manufacturing Part Number: E4406-90291  
Supersedes E4406-90258**

**Printed in USA**

**November 2005**

© Copyright 1999 - 2005 Agilent Technologies, Inc.

The information contained in this document is subject to change without notice.

Agilent Technologies makes no warranty of any kind with regard to this material, including but not limited to, the implied warranties of merchantability and fitness for a particular purpose. Agilent Technologies shall not be liable for errors contained herein or for incidental or consequential damages in connection with the furnishing, performance, or use of this material.

## 1. Introduction

What Does the Agilent PSA Series and VSA E4406A Option 204 Do? . . . . .	42
Installing Optional Measurement Personalities . . . . .	43
Do You Have Enough Memory to Load All Your Personality Options? . . . . .	43
How to Predict Your Memory Requirements . . . . .	45
Loading an Optional Measurement Personality . . . . .	47
Obtaining and Installing a License Key . . . . .	48
Viewing a License Key . . . . .	49
Using the Delete License Key on PSA . . . . .	49
Using the Uninstall Key on E4406A . . . . .	50
Performing a Security Erase on PSA Series Spectrum Analyzers . . . . .	50
Ordering Optional Measurement Personalities . . . . .	52

## 2. Making Measurements

1xEV-DO Measurements . . . . .	54
Instrument Front Panel Highlights . . . . .	55
Setting up and Making a Measurement . . . . .	58
Making the Initial Signal Connection . . . . .	58
Using Instrument Mode and Measurement Presets . . . . .	58
The 3 Steps to Set Up and Make Measurements . . . . .	59
Channel Power Measurements . . . . .	60
Configuring the Measurement System . . . . .	60
Setting Up the BTS . . . . .	60
Measurement Procedure . . . . .	61
Forward Link Code Domain Measurements . . . . .	63
Configuring the Measurement System . . . . .	63
Setting the BTS . . . . .	64
Measurement Procedure . . . . .	64
Troubleshooting Hints . . . . .	70
Reverse Link Code Domain Measurements . . . . .	72
Configuring the Measurement System . . . . .	72
Setting the MS . . . . .	73
Measurement Procedure . . . . .	73
Troubleshooting Hints . . . . .	84
Intermodulation Measurements . . . . .	85
Configuring the Measurement System . . . . .	85
Setting the BTS and Signal Generator . . . . .	86
Measurement Procedure . . . . .	87
Troubleshooting Hints . . . . .	88
Forward Link Modulation Accuracy (Composite Rho) Measurements . . . . .	89
Configuring the Measurement System . . . . .	89
Setting the BTS . . . . .	90
Measurement Procedure . . . . .	90
Troubleshooting Hints . . . . .	95
Reverse Link Modulation Accuracy (Composite Rho) Measurements . . . . .	96
Configuring the Measurement System . . . . .	96
Setting the MS . . . . .	97
Measurement Procedure . . . . .	97

---

# Contents

Troubleshooting Hints . . . . .	102
Occupied Bandwidth Measurements . . . . .	103
Configuring the Measurement System . . . . .	103
Setting the BTS . . . . .	103
Measurement Procedure . . . . .	104
Troubleshooting Hints . . . . .	105
Power Statistics CCDF Measurements . . . . .	106
Configuring the Measurement System . . . . .	106
Setting the BTS . . . . .	106
Measurement Procedure . . . . .	107
Troubleshooting Hints . . . . .	108
Power versus Time Measurements . . . . .	109
Configuring the Measurement System . . . . .	109
Setting the BTS . . . . .	109
Measurement Procedure . . . . .	110
Troubleshooting Hints . . . . .	112
QPSK EVM Measurements . . . . .	113
Configuring the Measurement System . . . . .	113
Setting the BTS . . . . .	114
Measurement Procedure . . . . .	115
Spectrum (Frequency Domain) Measurements . . . . .	118
Configuring the Measurement System . . . . .	118
Setting the BTS . . . . .	119
Measurement Procedure . . . . .	119
Spurious Emissions & ACP Measurements . . . . .	128
Configuring the Measurement System . . . . .	128
Setting the BTS . . . . .	129
Measurement Procedure . . . . .	129
Troubleshooting Hints . . . . .	131
Waveform (Time Domain) Measurements . . . . .	133
Configuring the Measurement System . . . . .	133
Setting the BTS . . . . .	134
Measurement Procedure . . . . .	134
Using Basic Mode . . . . .	141
Basic Mode in E4406A VSA Series Transmitter Testers . . . . .	141
Basic Mode in PSA Series Spectrum Analyzers . . . . .	141
Understanding Common Measurement Errors . . . . .	142
<b>3. Key Reference</b>	
Instrument Front Panel Highlights . . . . .	146
Front Panel Keys . . . . .	149
FREQUENCY Channel Key Menu . . . . .	149
MEASURE Key Menu . . . . .	149
Meas Control Key Menu . . . . .	152
Mode Setup Key Menus . . . . .	153
Input/Output Key Menu . . . . .	157
1xEV-DO Measurement Keys . . . . .	160
Channel Power Keys . . . . .	160
Code Domain Keys (Forward Link) . . . . .	163

Code Domain Keys (Reverse Link) . . . . .	172
Intermodulation Keys (Radio Device = BTS only) . . . . .	187
Modulation Accuracy (Composite Rho)(forward link) Keys . . . . .	191
Modulation Accuracy (Composite Rho) (reverse link) Keys . . . . .	207
Occupied Bandwidth Keys . . . . .	220
Power Stat CCDF Keys . . . . .	223
Power Versus Time Keys (Radio Device = BTS only) . . . . .	225
QPSK EVM Keys (Radio Device = BTS only) . . . . .	232
Spectrum (Frequency Domain) Keys . . . . .	241
Spurious Emissions & ACP Keys (Radio Device = BTS only) . . . . .	257
Waveform (Time Domain) Keys . . . . .	271
<b>4. Programming Commands</b>	
SCPI Command Subsystems . . . . .	290
Programming Command Compatibility	
Across Model Numbers and Across Modes . . . . .	291
Across PSA Modes: Command Subsystem Similarities . . . . .	291
Across PSA Modes: Specific Command Differences . . . . .	293
Using Applications in PSA Series vs. VSA E4406A . . . . .	294
CALCulate Subsystem . . . . .	296
Test Current Results Against all Limits . . . . .	296
Data Query . . . . .	296
Calculate/Compress Trace Data Query . . . . .	296
Calculate Peaks of Trace Data . . . . .	303
CALCulate:MARKers Subsystem . . . . .	305
Code Domain Power . . . . .	316
Occupied Bandwidth - Limits . . . . .	322
Power Statistic CCDF—Store Reference . . . . .	324
Terminal Code Domain Power Measurement . . . . .	324
Terminal Modulation Accuracy Measurement . . . . .	336
CONFigure Subsystem . . . . .	352
Configure the Selected Measurement . . . . .	352
Configure Query . . . . .	352
DISPlay Subsystem . . . . .	353
Code Domain - View Selection . . . . .	353
Select Display Format . . . . .	353
Select Display Format . . . . .	354
PVT - Limit Mask Display . . . . .	354
PVT - Burst Search Threshold Line . . . . .	354
PVT - View Selection . . . . .	355
Modulation Accuracy (Rho) - View Selection . . . . .	355
Spectrum - Y-Axis Scale/Div . . . . .	356
Spectrum - Y-Axis Reference Level . . . . .	357
Terminal Code Domain Measurement - View Selection . . . . .	358
Terminal Modulation Accuracy Measurement - Select View . . . . .	359
Turn a Trace Display On/Off . . . . .	359
Waveform - Y-Axis Scale/Div . . . . .	364
Waveform - Y-Axis Reference Level . . . . .	365
FETCh Subsystem . . . . .	367

---

# Contents

Fetch the Current Measurement Results	.367
FORMat Subsystem	.368
Byte Order	.368
Numeric Data Format	.368
INITiate Subsystem	.370
Take New Data Acquisition for Selected Measurement	.370
Continuous or Single Measurements	.370
Take New Data Acquisitions	.371
Restart the Measurement	.371
INSTrument Subsystem	.372
Catalog Query	.372
Select Application by Number	.372
Select Application	.373
MEASure Group of Commands	.375
Command Interactions: MEASure, CONFigure, FETCh, INITiate and READ	.376
Code Domain Power Measurement	.380
Channel Power Measurement	.386
QPSK Error Vector Magnitude Measurement	.388
Intermodulation Measurement	.391
Occupied Bandwidth Measurement	.394
Power Statistics CCDF Measurement	.395
Power vs. Time Measurement	.397
Modulation Accuracy (Rho) Measurement	.401
Spurious Emissions Measurement	.408
Spectrum (Frequency Domain) Measurement	.414
Terminal Code Domain Measurement	.417
Terminal Modulation Accuracy (Rho) Measurement	.426
Waveform (Time Domain) Measurement	.436
READ Subsystem	.438
Initiate and Read Measurement Data	.438
SENSE Subsystem	.439
Code Domain Measurement	.439
Channel Power Measurement	.445
Signal Corrections Commands	.449
QPSK Error Vector Magnitude Measurement	.450
RF Input Signal Alignments	.455
Intermodulation Measurement	.456
Occupied Bandwidth Measurement	.462
RF Power Commands	.466
Power Statistics CCDF Measurement	.469
Power vs. Time Measurement	.471
Radio Standards Commands	.485
Modulation Accuracy (Rho) Measurement	.487
Spectrum Emission Mask Measurement	.493
Spectrum (Frequency-Domain) Measurement	.531
Terminal Code Domain Measurement	.545
Terminal Modulation Accuracy Measurement	.556
Waveform (Time-Domain) Measurement	.569
TRIGger Subsystem	.577

Automatic Trigger Control .....	577
Automatic Trigger Time .....	577
External Trigger Delay .....	578
External Trigger Level .....	578
External Trigger Slope .....	578
Frame Trigger Adjust .....	579
Frame Trigger Period .....	579
Frame Trigger Sync Source .....	580
Frame Trigger Synchronization Offset .....	580
Trigger Holdoff .....	581
Video (IF) Trigger Delay .....	581
Video (IF) Trigger Level .....	581
Video (IF) Trigger Slope .....	582
RF Burst Trigger Delay .....	582
RF Burst Trigger Level .....	582
RF Burst Trigger Slope .....	583

**5. Concepts**

What Is the 1xEV-DO System? .....	586
RF Characteristics .....	586
Access Terminal & Access Network .....	586
Forward Link .....	586
Reverse Link Coding .....	589
Standard Documents .....	591
Channel Power Measurement Concepts .....	592
Purpose .....	592
Measurement Method .....	592
Code Domain Measurement Concepts .....	593
Purpose .....	593
Measurement Method .....	593
Intermodulation Measurement Concepts .....	595
Purpose .....	595
Measurement Method .....	595
Troubleshooting Hints .....	595
Modulation Accuracy (Composite Rho) Measurement Concepts .....	597
Purpose .....	597
Measurement Method .....	597
Occupied Bandwidth Measurement Concepts .....	599
Purpose .....	599
Measurement Method .....	599
Power Statistics CCDF Measurement Concepts .....	600
Purpose .....	600
Measurement Method .....	600
Power versus Time Measurement Concepts .....	601
Purpose .....	601
Measurement Method .....	601
QPSK EVM Measurement Concepts .....	602
Purpose .....	602
Measurement Method .....	602

---

# Contents

Spectrum (Frequency Domain) Measurement Concepts . . . . .	.603
Purpose . . . . .	.603
Measurement Method . . . . .	.603
Troubleshooting Hints . . . . .	.603
Spurious Emissions and Adjacent Channel Power Measurement Concepts . . . . .	.604
Purpose . . . . .	.604
Measurement Method . . . . .	.604
Waveform (Time Domain) Measurement Concepts . . . . .	.606
Purpose . . . . .	.606
Measurement Method . . . . .	.606
Other Sources of Measurement Information . . . . .	.607
Instrument Updates at <a href="http://www.agilent.com">www.agilent.com</a> . . . . .	.607
<b>6. Menu Maps</b>	
1xEV-DO Measurement Key Flow . . . . .	.610
How to Read Menu Map Diagrams . . . . .	.611
Menu Map Diagrams . . . . .	.612



---

# List of Commands

:CALCulate:<measurement>:MARKer:AOFF .....	308
:CALCulate:<measurement>:MARKer[1]   2   3   4:FUNCtion:RESult? .....	308
:CALCulate:<measurement>:MARKer[1]   2   3   4:MAXimum .....	309
:CALCulate:<measurement>:MARKer[1]   2   3   4:MINimum .....	309
:CALCulate:<measurement>:MARKer[1]   2   3   4:MODE POSition   DELTa .....	309
:CALCulate:<measurement>:MARKer[1]   2   3   4:MODE POSition   DELTa   RMSDegree   RMSRadian   RFM   RMSJitter   OFF .....	309
:CALCulate:<measurement>:MARKer[1]   2   3   4:MODE? .....	310
:CALCulate:<measurement>:MARKer[1]   2   3   4:TRACe <trace_name> .....	311
:CALCulate:<measurement>:MARKer[1]   2   3   4:TRACe? .....	311
:CALCulate:<measurement>:MARKer[1]   2   3   4:X <param> .....	315
:CALCulate:<measurement>:MARKer[1]   2   3   4:X:POSition <integer> .....	315
:CALCulate:<measurement>:MARKer[1]   2   3   4:X:POSition? .....	315
:CALCulate:<measurement>:MARKer[1]   2   3   4:X? .....	315
:CALCulate:<measurement>:MARKer[1]   2   3   4:Y? .....	316
:CALCulate:<measurement>:MARKer[1]   2   3   4[:STATe] OFF   ON   0   1 .....	310
:CALCulate:<measurement>:MARKer[1]   2   3   4[:STATe]? .....	310
:CALCulate:CDPower:ASET:THReshold <numeric> .....	316
:CALCulate:CDPower:ASET:THReshold:AUTO OFF   ON   0   1 .....	317
:CALCulate:CDPower:ASET:THReshold:AUTO? .....	317
:CALCulate:CDPower:ASET:THReshold? .....	316
:CALCulate:CDPower:CHANnel:TYPE DATA   MAC   PILot .....	317
:CALCulate:CDPower:CHANnel:TYPE? .....	317
:CALCulate:CDPower:IQ:COMBined[:STATe] OFF   ON   0   1 .....	317
:CALCulate:CDPower:IQ:COMBined[:STATe]? .....	317
:CALCulate:CDPower:SWEep:OFFSet <float> .....	318
:CALCulate:CDPower:SWEep:OFFSet <integer> .....	318
:CALCulate:CDPower:SWEep:OFFSet? .....	318
:CALCulate:CDPower:SWEep:TIME <float> .....	319
:CALCulate:CDPower:SWEep:TIME <integer> .....	319
:CALCulate:CDPower:SWEep:TIME? .....	319

---

# List of Commands

:CALCulate:CDPower:TYPE ABSolute   RELative. . . . .	.320
:CALCulate:CDPower:TYPE:DATA OPSK   QAM   QPSK . . . . .	.320
:CALCulate:CDPower:TYPE:DATA? . . . . .	.320
:CALCulate:CDPower:TYPE? . . . . .	.320
:CALCulate:CDPower:WCODE:ORDER BREVerse   HADmrd . . . . .	.321
:CALCulate:CDPower:WCODE:ORDER? . . . . .	.321
:CALCulate:CDPower:WCODE[:NUMBER] <integer> . . . . .	.320
:CALCulate:CDPower:WCODE[:NUMBER]? . . . . .	.320
:CALCulate:CLIMits:FAIL?. . . . .	.296
:CALCulate:DATA<n>:COMPRESS? BLOCK   CFIT   MAXimum   MEAN   MINimum   RMS   SAMple   SDEviation[,<soffset>[,<length>[,<roffset>[,<rlimit>]]]] . . . . .	.296
:CALCulate:DATA<n>:PEAKs? <threshold>,<excursion>[,AMPLitude   FREQuency   TIME] . . . . .	.303
:CALCulate:DATA[n]? . . . . .	.296
:CALCulate:OBW:LIMit:FBLimit <freq> . . . . .	.322
:CALCulate:OBW:LIMit:FBLimit? . . . . .	.322
:CALCulate:OBW:LIMit[:TEST] OFF   ON   0   1. . . . .	.322
:CALCulate:OBW:LIMit[:TEST]? . . . . .	.322
:CALCulate:OBWidth:LIMit:FBLimit <freq> . . . . .	.322
:CALCulate:OBWidth:LIMit:FBLimit? . . . . .	.322
:CALCulate:OBWidth:LIMit:STATe OFF   ON   0   1 . . . . .	.322
:CALCulate:OBWidth:LIMit:STATe? . . . . .	.322
:CALCulate:PSTatistic:STORE:REFerence ON   1 . . . . .	.324
:CALCulate:RHO:ASET:THReshold <numeric> . . . . .	.330
:CALCulate:RHO:ASET:THReshold:AUTO OFF   ON   0   1. . . . .	.331
:CALCulate:RHO:ASET:THReshold:AUTO? . . . . .	.331
:CALCulate:RHO:ASET:THReshold? . . . . .	.330
:CALCulate:RHO:IQOffset:INCLude OFF   ON   0   1 . . . . .	.331
:CALCulate:RHO:IQOffset:INCLude? . . . . .	.331
:CALCulate:RHO:LIMit:DATA[:ACTive]:LOWer <float> . . . . .	.331
:CALCulate:RHO:LIMit:DATA[:ACTive]:LOWer? . . . . .	.331
:CALCulate:RHO:LIMit:DATA[:ACTive][:UPPer] <float> . . . . .	.332

---

## List of Commands

:CALCulate:RHO:LIMit:DATA[:ACTive][:UPPer]?	332
:CALCulate:RHO:LIMit:FREQuency <numeric>	332
:CALCulate:RHO:LIMit:FREQuency?	332
:CALCulate:RHO:LIMit:MAC:INACTive[:UPPer]<float>	332
:CALCulate:RHO:LIMit:MAC:INACTive[:UPPer]?	332
:CALCulate:RHO:LIMit:PEAK[:BTS] <float>	333
:CALCulate:RHO:LIMit:PEAK[:BTS]?	333
:CALCulate:RHO:LIMit:PHASe <float>	333
:CALCulate:RHO:LIMit:PHASe?	333
:CALCulate:RHO:LIMit:POFFset <float>	333
:CALCulate:RHO:LIMit:POFFset?	333
:CALCulate:RHO:LIMit:RHO[:BTS] <float>	334
:CALCulate:RHO:LIMit:RHO[:BTS]?	334
:CALCulate:RHO:LIMit:RMS[:BTS] <float>	334
:CALCulate:RHO:LIMit:RMS[:BTS]?	334
:CALCulate:RHO:LIMit:TIMing <float>	334
:CALCulate:RHO:LIMit:TIMing?	334
:CALCulate:RHO:TYPE ALL   DATA   MAC   PILot   PREamble	334
:CALCulate:RHO:TYPE:DATA OPSK   QAM   QPSK	335
:CALCulate:RHO:TYPE:DATA?	335
:CALCulate:RHO:TYPE?	334
:CALCulate:TCDPower:ASET:THReshold <rel_ampl>	324
:CALCulate:TCDPower:ASET:THReshold:AUTO OFF   ON   0   1	324
:CALCulate:TCDPower:ASET:THReshold:AUTO?	324
:CALCulate:TCDPower:ASET:THReshold?	324
:CALCulate:TCDPower:AXIS IPH   QPH   IQCombined	325
:CALCulate:TCDPower:AXIS?	325
:CALCulate:TCDPower:IQ:COMBined[:STATe] ON   OFF   0   1	325
:CALCulate:TCDPower:IQ:COMBined[:STATe]?	325
:CALCulate:TCDPower:MARKer:TRACe CDPower   CDError   EVM   MERRor   PERRor   SPOW- er   CPOWer	326

---

# List of Commands

:CALCulate:TCDPower:MARKer:TRACe?	.326
:CALCulate:TCDPower:PACKed OFF   PKM1	.326
:CALCulate:TCDPower:PACKed?	.326
:CALCulate:TCDPower:SEVM:FCOMpen ON   OFF   0   1	.327
:CALCulate:TCDPower:SEVM:FCOMpen?	.327
:CALCulate:TCDPower:SEVM:PCOMpen ON   OFF   0   1	.327
:CALCulate:TCDPower:SEVM:PCOMpen?	.327
:CALCulate:TCDPower:SWEep:OFFSet <integer>	.328
:CALCulate:TCDPower:SWEep:OFFSet?	.328
:CALCulate:TCDPower:SWEep:TIME <integer>	.328
:CALCulate:TCDPower:SWEep:TIME?	.328
:CALCulate:TCDPower:TYPE ABSolute   RELative	.329
:CALCulate:TCDPower:TYPE?	.329
:CALCulate:TCDPower:WCODe:ORDer BREVerse   (HADamard   HADMrd)	.330
:CALCulate:TCDPower:WCODe:ORDer?	.330
:CALCulate:TCDPower:WCODe[:NUMBer] <integer>	.329
:CALCulate:TCDPower:WCODe[:NUMBer]?	.329
:CALCulate:TRHO:ASET:THReshold <numeric>	.337
:CALCulate:TRHO:ASET:THReshold:AUTO OFF   ON   0   1	.337
:CALCulate:TRHO:ASET:THReshold:AUTO?	.337
:CALCulate:TRHO:ASET:THReshold?	.337
:CALCulate:TRHO:IQ:COMBined[:STATe] ON   OFF   0   1	.336
:CALCulate:TRHO:IQ:COMBined[:STATe]?	.336
:CALCulate:TRHO:IQOFfset:INCLude OFF   ON   0   1	.337
:CALCulate:TRHO:IQOFfset:INCLude?	.337
:CALCulate:TRHO:LIMit:ACDPower <float>	.338
:CALCulate:TRHO:LIMit:ACDPower?	.338
:CALCulate:TRHO:LIMit:ACDPower[:SUB0] <real>	.348
:CALCulate:TRHO:LIMit:ACDPower[:SUB0]?	.348
:CALCulate:TRHO:LIMit:ACK:GAIN <float>	.338
:CALCulate:TRHO:LIMit:ACK:GAIN?	.338

---

## List of Commands

:CALCulate:TRHO:LIMit:ACK:GAIN[:SUB0] <real> . . . . .	349
:CALCulate:TRHO:LIMit:ACK:GAIN[:SUB0]? . . . . .	349
:CALCulate:TRHO:LIMit:CDErRor <float> . . . . .	338
:CALCulate:TRHO:LIMit:CDErRor:SUB2 <real> . . . . .	345
:CALCulate:TRHO:LIMit:CDErRor:SUB2? . . . . .	345
:CALCulate:TRHO:LIMit:CDErRor? . . . . .	338
:CALCulate:TRHO:LIMit:CDErRor[:SUB0] <real> . . . . .	344
:CALCulate:TRHO:LIMit:CDErRor[:SUB0]? . . . . .	344
:CALCulate:TRHO:LIMit:DATA:GAIN <float> . . . . .	339
:CALCulate:TRHO:LIMit:DATA:GAIN? . . . . .	339
:CALCulate:TRHO:LIMit:DATA:GAIN[:SUB0] <real> . . . . .	350
:CALCulate:TRHO:LIMit:DATA:GAIN[:SUB0]? . . . . .	350
:CALCulate:TRHO:LIMit:DRC:GAIN <float> . . . . .	339
:CALCulate:TRHO:LIMit:DRC:GAIN? . . . . .	339
:CALCulate:TRHO:LIMit:DRC:GAIN[:SUB0] <real> . . . . .	349
:CALCulate:TRHO:LIMit:DRC:GAIN[:SUB0]? . . . . .	349
:CALCulate:TRHO:LIMit:FERRor <float> . . . . .	339
:CALCulate:TRHO:LIMit:FERRor:SUB2 <real> . . . . .	346
:CALCulate:TRHO:LIMit:FERRor:SUB2? . . . . .	346
:CALCulate:TRHO:LIMit:FERRor? . . . . .	339
:CALCulate:TRHO:LIMit:FERRor[:SUB0] <real> . . . . .	345
:CALCulate:TRHO:LIMit:FERRor[:SUB0]? . . . . .	345
:CALCulate:TRHO:LIMit:ICDPower <float> . . . . .	339
:CALCulate:TRHO:LIMit:ICDPower:SUB2 <real> . . . . .	340
:CALCulate:TRHO:LIMit:ICDPower:SUB2? . . . . .	340
:CALCulate:TRHO:LIMit:ICDPower? . . . . .	339
:CALCulate:TRHO:LIMit:ICDPower[:SUB0] <real> . . . . .	340
:CALCulate:TRHO:LIMit:ICDPower[:SUB0]? . . . . .	340
:CALCulate:TRHO:LIMit:PEAK <float> . . . . .	341
:CALCulate:TRHO:LIMit:PEAK:SUB2? . . . . .	343
:CALCulate:TRHO:LIMit:PEAK;SUB2 <real> . . . . .	343

---

# List of Commands

:CALCulate:TRHO:LIMit:PEAK?	.341
:CALCulate:TRHO:LIMit:PEAK[:SUB0] <real>	.343
:CALCulate:TRHO:LIMit:PEAK[:SUB0]?	.343
:CALCulate:TRHO:LIMit:POFFset <float>	.341
:CALCulate:TRHO:LIMit:POFFset:SUB2 <real>	.347
:CALCulate:TRHO:LIMit:POFFset:SUB2?	.347
:CALCulate:TRHO:LIMit:POFFset?	.341
:CALCulate:TRHO:LIMit:POFFset[:SUB0] <real>	.346
:CALCulate:TRHO:LIMit:POFFset[:SUB0]?	.346
:CALCulate:TRHO:LIMit:RHO <float>	.341
:CALCulate:TRHO:LIMit:RHO:SUB2 <real>	.344
:CALCulate:TRHO:LIMit:RHO:SUB2?	.344
:CALCulate:TRHO:LIMit:RHO?	.341
:CALCulate:TRHO:LIMit:RHO[:SUB0] <real>	.344
:CALCulate:TRHO:LIMit:RHO[:SUB0]?	.344
:CALCulate:TRHO:LIMit:RMS <float>	.342
:CALCulate:TRHO:LIMit:RMS:SUB0<real>	.347
:CALCulate:TRHO:LIMit:RMS:SUB0?	.347
:CALCulate:TRHO:LIMit:RMS:SUB2 <real>	.347
:CALCulate:TRHO:LIMit:RMS:SUB2?	.348
:CALCulate:TRHO:LIMit:RMS?	.342
:CALCulate:TRHO:LIMit:RMS[:SUB0] <real>	.342
:CALCulate:TRHO:LIMit:RMS[:SUB0]?	.342
:CALCulate:TRHO:LIMit:RRI <float>	.342
:CALCulate:TRHO:LIMit:RRI?	.342
:CALCulate:TRHO:LIMit:RRI[:SUB0] <real>	.348
:CALCulate:TRHO:LIMit:RRI[:SUB0]?	.348
:CALCulate:TRHO:MARKer:TRACe EVM   MERRor   PERRor   CDPower	.350
:CALCulate:TRHO:MARKer:TRACe?	.350
:CALCulate:TRHO:SWEep:OFFSet <integer>	.351
:CALCulate:TRHO:SWEep:OFFSet?	.351

---

# List of Commands

:CALCulate:TRHO:WCODe:ORDer BREVerse   HADMrd	351
:CALCulate:TRHO:WCODe:ORDer?	351
:CONFigure:<measurement>	352
:CONFigure:CDPower	380
:CONFigure:CHPower	386
:CONFigure:EVMQpsk	388
:CONFigure:IM	391
:CONFigure:OBW	394
:CONFigure:PStatistic	395
:CONFigure:PVTime	397
:CONFigure:RHO	401
:CONFigure:SEMask	408
:CONFigure:SPEctrum	414
:CONFigure:TCDPower	417
:CONFigure:TRHO	426
:CONFigure:WAVEform	436
:CONFigure?	352
:DISPlay:CDPower:VIEW PG Raph   IQPGraph	353
:DISPlay:CDPower:VIEW?	353
:DISPlay:FORMat:TILE	353
:DISPlay:FORMat:ZOOM	354
:DISPlay:PVTime:BURSt:STHReshold OFF   ON   0   1	354
:DISPlay:PVTime:BURSt:STHReshold?	354
:DISPlay:PVTime:LIMit:MASK OFF   ON   0   1	354
:DISPlay:PVTime:LIMit:MASK?	354
:DISPlay:PVTime:VIEW ALL   BOTH   A   B   C   D   E	355
:DISPlay:PVTime:VIEW?	355
:DISPlay:RHO:VIEW ERRor   POLar	355
:DISPlay:RHO:VIEW ERRor   POLar   PG Raph   TABLE	355
:DISPlay:RHO:VIEW ERRor   POLar   QUAD   TABLE   TPHase	355
:DISPlay:RHO:VIEW ERRor   POLar   TABLE	355

---

# List of Commands

:DISPlay:RHO:VIEW? .....	.355
:DISPlay:SPECtrum[n]:WINDow[m]:TRACe:Y[:SCALe]:PDIVision <power> .....	.356
:DISPlay:SPECtrum[n]:WINDow[m]:TRACe:Y[:SCALe]:PDIVision? .....	.356
:DISPlay:SPECtrum[n]:WINDow[m]:TRACe:Y[:SCALe]:RLEVel <power> .....	.357
:DISPlay:SPECtrum[n]:WINDow[m]:TRACe:Y[:SCALe]:RLEVel? .....	.357
:DISPlay:TCDPower:VIEW PGRaph   SEVM   QUAD   DBITs   CDPError .....	.358
:DISPlay:TCDPower:VIEW? .....	.358
:DISPlay:TRACe[n][:STATe] OFF   ON   0   1 .....	.359
:DISPlay:TRACe[n][:STATe]? .....	.359
:DISPlay:TRHO:VIEW POLar   ERRor   TABLE   CDPower .....	.359
:DISPlay:TRHO:VIEW? .....	.359
:DISPlay:WAVEform[n]:WINDow[m]:TRACe:Y[:SCALe]:PDIVision <power> .....	.364
:DISPlay:WAVEform[n]:WINDow[m]:TRACe:Y[:SCALe]:PDIVision? .....	.364
:DISPlay:WAVEform[n]:WINDow[m]:TRACe:Y[:SCALe]:RLEVel <power> .....	.365
:DISPlay:WAVEform[n]:WINDow[m]:TRACe:Y[:SCALe]:RLEVel? .....	.365
:FETCh:<measurement>[n]? .....	.367
:FETCh:CDPower[n]? .....	.380
:FETCh:CHPower[n]? .....	.386
:FETCh:EVMQpsk[n]? .....	.388
:FETCh:IM[n]? .....	.391
:FETCh:OBW[n]? .....	.394
:FETCh:PSTatistic[n]? .....	.395
:FETCh:PVTime[n]? .....	.397
:FETCh:RHO[n]? .....	.401
:FETCh:SEMAsk[n]? .....	.408
:FETCh:SPECtrum[n]? .....	.414
:FETCh:TCDPower[n]? .....	.417
:FETCh:TRHO[n]? .....	.426
:FETCh:WAVEform[n]? .....	.436
:FORMat:BORDER NORMal   SWAPPed .....	.368
:FORMat:BORDER? .....	.368



---

# List of Commands

:FORMat[:DATA] ASCii   REAL,32   REAL,64 . . . . .	368
:FORMat[:DATA]? . . . . .	368
:FORMat[:TRACe][:DATA] ASCii   INTeger,16   INTeger,32   REAL,32   REAL,64   UINTEger,16 . . . . .	368
:FORMat[:TRACe][:DATA] ASCii   REAL[,32] . . . . .	368
:FORMat[:TRACe][:DATA]? . . . . .	368
:FORMat[:TRACe][:DATA]? . . . . .	368
:INITiate:<measurement> . . . . .	370
:INITiate:CDPower . . . . .	380
:INITiate:CHPower . . . . .	386
:INITiate:CONTinuous OFF   ON   0   1 . . . . .	370
:INITiate:CONTinuous? . . . . .	370
:INITiate:EVMQpsk . . . . .	388
:INITiate:IM . . . . .	391
:INITiate:OBW . . . . .	394
:INITiate:PStatistic . . . . .	395
:INITiate:PVTime . . . . .	397
:INITiate:REStart . . . . .	371
:INITiate:RHO . . . . .	401
:INITiate:SEMAsk . . . . .	408
:INITiate:SPECTrum . . . . .	414
:INITiate:TCDPower . . . . .	417
:INITiate:TRHO . . . . .	426
:INITiate:WAVeform . . . . .	436
:INITiate[:IMMEdiate] . . . . .	371
:INSTRument:CATalog? . . . . .	372
:INSTRument:CATalog[:FULL]? . . . . .	372
:INSTRument:NSElect <integer> . . . . .	372
:INSTRument:NSElect? . . . . .	372
:INSTRument[:SElect] BASIC   SERVICE   CD- MA   CDMA2K   GSM   EDGEgsm   IDEN   NADC   PDC   WCDMA   CDMA1XEV . . . . .	373
:INSTRument[:SElect] SA   PNOISE   BASIC   CDMA   CDMA2K   EDGEgsm   NADC   PDC   WCD-	

---

# List of Commands

MA   CDMA1XEV   NFIGURE   WLAN   TDSCDMA . . . . .	374
:INSTrument[:SElect]? . . . . .	374
:MEASure:CDPower[n]? . . . . .	380
:MEASure:CHPower[n]? . . . . .	386
:MEASure:EVMQpsk[n]? . . . . .	388
:MEASure:IM[n]? . . . . .	391
:MEASure:OBW[n]? . . . . .	394
:MEASure:PSTatastic[n]? . . . . .	395
:MEASure:PVTime[n]? . . . . .	397
:MEASure:RHO[n]? . . . . .	401
:MEASure:SEMask[n]? . . . . .	408
:MEASure:SPECtrum[n]? . . . . .	414
:MEASure:TCDPower[n]? . . . . .	417
:MEASure:TRHO[n]? . . . . .	426
:MEASure:WAVeform[n]? . . . . .	436
:READ:<measurement>[n]? . . . . .	438
:READ:CDPower[n]? . . . . .	380
:READ:CHPower[n]? . . . . .	386
:READ:EVMQpsk[n]? . . . . .	388
:READ:IM[n]? . . . . .	391
:READ:OBW[n]? . . . . .	394
:READ:PSTatastic[n]? . . . . .	395
:READ:PVTime[n]? . . . . .	397
:READ:RHO[n]? . . . . .	401
:READ:SEMask[n]? . . . . .	408
:READ:SPECtrum[n]? . . . . .	414
:READ:TCDPower[n]? . . . . .	417
:READ:TRHO[n]? . . . . .	426
:READ:WAVeform[n]? . . . . .	436
:TRIGger[:SEquence]:AUTO:STATe OFF   ON   0   1 . . . . .	577
:TRIGger[:SEquence]:AUTO:STATe? . . . . .	577

---

## List of Commands

:TRIGger[:SEQuence]:AUTO[:TIME] <time> . . . . .	577
:TRIGger[:SEQuence]:AUTO[:TIME]? . . . . .	577
:TRIGger[:SEQuence]:EXTErnal[1]   2:DELAy <time> . . . . .	578
:TRIGger[:SEQuence]:EXTErnal[1]   2:DELAy? . . . . .	578
:TRIGger[:SEQuence]:EXTErnal[1]   2:LEVel <voltage> . . . . .	578
:TRIGger[:SEQuence]:EXTErnal[1]   2:LEVel? . . . . .	578
:TRIGger[:SEQuence]:EXTErnal[1]   2:SLOPe NEGative   POSitive . . . . .	578
:TRIGger[:SEQuence]:EXTErnal[1]   2:SLOPe? . . . . .	579
:TRIGger[:SEQuence]:FRAME:ADJust <time> . . . . .	579
:TRIGger[:SEQuence]:FRAME:PERiod <time> . . . . .	579
:TRIGger[:SEQuence]:FRAME:PERiod? . . . . .	579
:TRIGger[:SEQuence]:FRAME:SYNC EXTFront   EXTReAr   OFF . . . . .	580
:TRIGger[:SEQuence]:FRAME:SYNC:OFFSet <time> . . . . .	580
:TRIGger[:SEQuence]:FRAME:SYNC:OFFSet? . . . . .	580
:TRIGger[:SEQuence]:FRAME:SYNC? . . . . .	580
:TRIGger[:SEQuence]:HOLDoff <time> . . . . .	581
:TRIGger[:SEQuence]:HOLDoff? . . . . .	581
:TRIGger[:SEQuence]:IF:DELAy <time> . . . . .	581
:TRIGger[:SEQuence]:IF:DELAy? . . . . .	581
:TRIGger[:SEQuence]:IF:LEVel <ampl> . . . . .	581
:TRIGger[:SEQuence]:IF:LEVel? . . . . .	581
:TRIGger[:SEQuence]:IF:SLOPe NEGative   POSitive . . . . .	582
:TRIGger[:SEQuence]:IF:SLOPe? . . . . .	582
:TRIGger[:SEQuence]:RFBurst:DELAy <time> . . . . .	582
:TRIGger[:SEQuence]:RFBurst:DELAy? . . . . .	582
:TRIGger[:SEQuence]:RFBurst:LEVel <rel_power> . . . . .	582
:TRIGger[:SEQuence]:RFBurst:LEVel? . . . . .	582
:TRIGger[:SEQuence]:RFBurst:SLOPe NEGative   POSitive . . . . .	583
:TRIGger[:SEQuence]:RFBurst:SLOPe? . . . . .	583
[:SENSe]:CDPower:ACODE AUTO   PREDeFined . . . . .	439
[:SENSe]:CDPower:ACODE? . . . . .	439

---

# List of Commands

[:SENSe]:CDPower:ADC:RANGe AUTO   APEak   APLOCK   M6   P0   P6   P12   P18   P24 . . . . .	439
[:SENSe]:CDPower:ADC:RANGe AUTO   APEak   APLOCK   NONE   P0   P6   P12   P18 . . . . .	439
[:SENSe]:CDPower:ADC:RANGe? . . . . .	439
[:SENSe]:CDPower:CAPTure:TIME <numeric> . . . . .	441
[:SENSe]:CDPower:CAPTure:TIME? . . . . .	441
[:SENSe]:CDPower:CRATe <freq> . . . . .	441
[:SENSe]:CDPower:CRATe? . . . . .	441
[:SENSe]:CDPower:PILOt:COMPensation[:STATe] OFF   ON   0   1 . . . . .	442
[:SENSe]:CDPower:PILOt:COMPensation[:STATe]? . . . . .	442
[:SENSe]:CDPower:PNOFfset <integer> . . . . .	442
[:SENSe]:CDPower:PNOFfset? . . . . .	442
[:SENSe]:CDPower:PREAmble:LENGth <integer> . . . . .	443
[:SENSe]:CDPower:PREAmble:LENGth:AUTO OFF   ON   0   1 . . . . .	443
[:SENSe]:CDPower:PREAmble:LENGth:AUTO? . . . . .	443
[:SENSe]:CDPower:PREAmble:LENGth? . . . . .	443
[:SENSe]:CDPower:SPECtrum INVert   NORMal . . . . .	443
[:SENSe]:CDPower:SPECtrum? . . . . .	443
[:SENSe]:CDPower:TRIGger:SOURce? . . . . .	444
[:SENSe]:CDPower:TRIGger:SOURceEXTernal[1]   External2   FRAME   IF   IMMEDIATE   RFBurst . . . . .	444
[:SENSe]:CHPower:AVERAge:TCONtrol EXPOntial   REPeat . . . . .	445
[:SENSe]:CHPower:AVERAge:TCONtrol? . . . . .	445
[:SENSe]:CHPower:AVERAge[:STATe] OFF   ON   0   1 . . . . .	445
[:SENSe]:CHPower:AVERAge[:STATe]? . . . . .	445
[:SENSe]:CHPower:FREQuency:SPAN <freq> . . . . .	446
[:SENSe]:CHPower:FREQuency:SPAN? . . . . .	446
[:SENSe]:CHPower:POINts <integer> . . . . .	446
[:SENSe]:CHPower:POINts:AUTO OFF   ON   0   1 . . . . .	446
[:SENSe]:CHPower:POINts:AUTO? . . . . .	446
[:SENSe]:CHPower:POINts? . . . . .	446
[:SENSe]:CHPower:SWEep:TIME <time> . . . . .	447

---

## List of Commands

[:SENSe]:CHPower:SWEep:TIME:AUTO OFF   ON   0   1 . . . . .	447
[:SENSe]:CHPower:SWEep:TIME:AUTO? . . . . .	447
[:SENSe]:CHPower:SWEep:TIME? . . . . .	447
[:SENSe]:CHPower:TRIGger:SOURce EXTernal[1]   EXTernal2   IMMEDIATE . . . . .	448
[:SENSe]:CHPower:TRIGger:SOURce? . . . . .	448
[:SENSe]:CORRection:BTS[:RF]:LOSS <rel_power> . . . . .	449
[:SENSe]:CORRection:BTS[:RF]:LOSS? . . . . .	449
[:SENSe]:CORRection:MS[:RF]:LOSS <rel_power> . . . . .	449
[:SENSe]:CORRection:MS[:RF]:LOSS? . . . . .	449
[:SENSe]:EVMQpsk:ADC:RANGe AUTO   APEak   APLock   M6   P0   P6   P12   P18   P24 . . . . .	450
[:SENSe]:EVMQpsk:ADC:RANGe AUTO   APEak   APLock   NONE   P0   P6   P12   P18 . . . . .	450
[:SENSe]:EVMQpsk:ADC:RANGe? . . . . .	450
[:SENSe]:EVMQpsk:AVERage:COUNt <integer> . . . . .	451
[:SENSe]:EVMQpsk:AVERage:COUNt? . . . . .	451
[:SENSe]:EVMQpsk:AVERage:TCONtrol EXPonential   REPeat . . . . .	452
[:SENSe]:EVMQpsk:AVERage:TCONtrol? . . . . .	452
[:SENSe]:EVMQpsk:AVERage[:STATe] OFF   ON   0   1 . . . . .	451
[:SENSe]:EVMQpsk:AVERage[:STATe]? . . . . .	451
[:SENSe]:EVMQpsk:CRATe <freq> . . . . .	452
[:SENSe]:EVMQpsk:CRATe? . . . . .	452
[:SENSe]:EVMQpsk:RFCarrier MULTiple   SINGle . . . . .	453
[:SENSe]:EVMQpsk:RFCarrier? . . . . .	453
[:SENSe]:EVMQpsk:SWEep:POINts <integer> . . . . .	453
[:SENSe]:EVMQpsk:SWEep:POINts:OFFSet <number> . . . . .	453
[:SENSe]:EVMQpsk:SWEep:POINts:OFFSet? . . . . .	453
[:SENSe]:EVMQpsk:SWEep:POINts? . . . . .	453
[:SENSe]:EVMQpsk:TRIGger:SOURce EXTernal[1]   EXTernal2   FRAMe   IF   IMMEDIATE   RFBurst 454	
[:SENSe]:EVMQpsk:TRIGger:SOURce? . . . . .	454
[:SENSe]:FEED RF   AREFERENCE   IFALign . . . . .	455
[:SENSe]:FEED RF   IQ   IONLY   QONLY   AREFERENCE   IFALign . . . . .	455

---

# List of Commands

[:SENSe]:FEED? .....	455
[:SENSe]:IM:AVERAge:COUNT <number> .....	456
[:SENSe]:IM:AVERAge:COUNT? .....	456
[:SENSe]:IM:AVERAge:TCONtrol EXPonential   REPeat .....	456
[:SENSe]:IM:AVERAge:TCONtrol? .....	456
[:SENSe]:IM:AVERAge[:STATe] OFF   ON   0   1 .....	456
[:SENSe]:IM:AVERAge[:STATe]? .....	456
[:SENSe]:IM:BANDwidth   BWIDth:INTegration <freq> .....	457
[:SENSe]:IM:BANDwidth   BWIDth:INTegration? .....	457
[:SENSe]:IM:BANDwidth   BWIDth[:RESolution] <freq> .....	457
[:SENSe]:IM:BANDwidth   BWIDth[:RESolution]:AUTO OFF   ON   0   1 .....	458
[:SENSe]:IM:BANDwidth   BWIDth[:RESolution]:AUTO? .....	458
[:SENSe]:IM:BANDwidth   BWIDth[:RESolution]? .....	457
[:SENSe]:IM:FREQuency:AUTO OFF   ON   0   1 .....	458
[:SENSe]:IM:FREQuency:AUTO? .....	458
[:SENSe]:IM:FREQuency:SPAN <freq> .....	460
[:SENSe]:IM:FREQuency:SPAN? .....	460
[:SENSe]:IM:FREQuency[:BASE]:DELTA <freq> .....	458
[:SENSe]:IM:FREQuency[:BASE]:DELTA? .....	458
[:SENSe]:IM:FREQuency[:BASE]:LOWer <freq> .....	459
[:SENSe]:IM:FREQuency[:BASE]:LOWer? .....	459
[:SENSe]:IM:FREQuency[:BASE]:UPPer <freq> .....	459
[:SENSe]:IM:FREQuency[:BASE]:UPPer? .....	459
[:SENSe]:IM:MODE AUTO   TWOTone   TXIM .....	460
[:SENSe]:IM:MODE? .....	460
[:SENSe]:IM:REFerence AUTO   AVERAge   LOWer   UPPer .....	460
[:SENSe]:IM:REFerence? .....	460
[:SENSe]:OBW:AVERAge:COUNT <integer> .....	462
[:SENSe]:OBW:AVERAge:COUNT? .....	462
[:SENSe]:OBW:AVERAge:TCONtrol EXPonential   REPeat .....	463
[:SENSe]:OBW:AVERAge:TCONtrol? .....	463

---

## List of Commands

[[:SENSe]:OBW:AVERage[:STATe] OFF   ON   0   1	462
[[:SENSe]:OBW:AVERage[:STATe]?	462
[[:SENSe]:OBW:BANDwidth   BWIDth[:RESolution] <freq>	463
[[:SENSe]:OBW:BANDwidth   BWIDth[:RESolution]?	463
[[:SENSe]:OBW:FFT:WINDow[:TYPE]?	464
[[:SENSe]:OBW:FFT:WINDow[:TYPE]BH4Tap   BLACKman   FLATtop   GAUSSian   HAMMing   HANNing   KB70   KB90   KB110   UNIFORM	463
[[:SENSe]:OBW:FREQuency:SPAN <freq>	464
[[:SENSe]:OBW:FREQuency:SPAN?	464
[[:SENSe]:OBW:TRIGger:SOURce EXTernal[1]   EXTernal2   FRAME   IF   IMMEDIATE   LINE   RFBurst.	464
[[:SENSe]:OBW:TRIGger:SOURce?	465
[[:SENSe]:POWER[:RF]:ATTenuation <rel_power>	466
[[:SENSe]:POWER[:RF]:ATTenuation?	466
[[:SENSe]:POWER[:RF]:GAIN:ATTenuation <rel_power>	466
[[:SENSe]:POWER[:RF]:GAIN:ATTenuation?	466
[[:SENSe]:POWER[:RF]:GAIN[:STATe] OFF   ON   0   1.	466
[[:SENSe]:POWER[:RF]:GAIN[:STATe]?	466
[[:SENSe]:POWER[:RF]:RANGe:AUTO OFF   ON   0   1.	467
[[:SENSe]:POWER[:RF]:RANGe:AUTO?	467
[[:SENSe]:POWER[:RF]:RANGe[:UPPer] <power>	467
[[:SENSe]:POWER[:RF]:RANGe[:UPPer]?	468
[[:SENSe]:PSTATistic:BANDwidth   BWIDth <freq>	469
[[:SENSe]:PSTATistic:BANDwidth   BWIDth?	469
[[:SENSe]:PSTATistic:COUNts <integer>	469
[[:SENSe]:PSTATistic:COUNts?	469
[[:SENSe]:PSTATistic:SWEep:TIME <time>	469
[[:SENSe]:PSTATistic:SWEep:TIME?	470
[[:SENSe]:PSTATistic:TRIGger:SOURce EXTernal[1]   EXTernal2   FRAME   IF   IMMEDIATE   RFBurst.	470
[[:SENSe]:PSTATistic:TRIGger:SOURce?	470
[[:SENSe]:PVTime:AVERage:COUNt <integer>	471

---

# List of Commands

[:SENSe]:PVTime:AVERAge:COUNT?	.471
[:SENSe]:PVTime:AVERAge:TCONtrol EXPONential   REPeat	.472
[:SENSe]:PVTime:AVERAge:TCONtrol?	.472
[:SENSe]:PVTime:AVERAge:TYPE LOG   MAXimum   MINimum   MXMinimum   RMS	.472
[:SENSe]:PVTime:AVERAge:TYPE LOG   MAXimum   MINimum   MXMinimum   RMS   SCALar	.472
[:SENSe]:PVTime:AVERAge:TYPE RMS   MAXimum   MINimum	.472
[:SENSe]:PVTime:AVERAge:TYPE?	.472
[:SENSe]:PVTime:AVERAge[:STATe] OFF   ON   0   1	.471
[:SENSe]:PVTime:AVERAge[:STATe]?	.471
[:SENSe]:PVTime:BANDwidth   BWIDth[:RESolution] <freq>	.473
[:SENSe]:PVTime:BANDwidth   BWIDth[:RESolution]:TYPE FLATtop   GAUSSian	.473
[:SENSe]:PVTime:BANDwidth   BWIDth[:RESolution]:TYPE?	.474
[:SENSe]:PVTime:BANDwidth   BWIDth[:RESolution]?	.473
[:SENSe]:PVTime:BURSt:SLOPe <number>	.474
[:SENSe]:PVTime:BURSt:SLOPe:INTegration:TIME <number>	.475
[:SENSe]:PVTime:BURSt:SLOPe:INTegration:TIME?	.475
[:SENSe]:PVTime:BURSt:SLOPe?	.475
[:SENSe]:PVTime:BURSt:STHReshold <rel_power>	.474
[:SENSe]:PVTime:BURSt:STHReshold?	.474
[:SENSe]:PVTime:LIMit:MASK OFF   ON   0   1	.475
[:SENSe]:PVTime:LIMit:MASK?	.475
[:SENSe]:PVTime:MASK:ASLot:LOWer:RELative <rel_power>	.476
[:SENSe]:PVTime:MASK:ASLot:LOWer:RELative?	.476
[:SENSe]:PVTime:MASK:ASLot:LOWer:TEST RELative   NONE	.476
[:SENSe]:PVTime:MASK:ASLot:LOWer:TEST?	.476
[:SENSe]:PVTime:MASK:ASLot:SWEep:TIME <time>	.476
[:SENSe]:PVTime:MASK:ASLot:SWEep:TIME?	.477
[:SENSe]:PVTime:MASK:ASLot:UPPer:RELative <rel_power>	.477
[:SENSe]:PVTime:MASK:ASLot:UPPer:RELative?	.477
[:SENSe]:PVTime:MASK:ASLot:UPPer:TEST RELative   NONE	.477
[:SENSe]:PVTime:MASK:ASLot:UPPer:TEST?	.477



---

## List of Commands

[SENSe]:PVTime:MASK:LIST:LOWer:RELative <rel_power>, <rel_power>, <rel_power>, <rel_power>, <rel_power> . . . . .	478
[SENSe]:PVTime:MASK:LIST:LOWer:RELative? . . . . .	478
[SENSe]:PVTime:MASK:LIST:LOWer:TEST RELative   NONE, ,RELative   NONE, RELative   NONE, RELative   NONE, RELative   NONE, RELative   NONE . . . . .	478
[SENSe]:PVTime:MASK:LIST:LOWer:TEST? . . . . .	479
[SENSe]:PVTime:MASK:LIST:SWEep:TIME <time>, <time>, <time>, <time>, <time> . . . . .	479
[SENSe]:PVTime:MASK:LIST:SWEep:TIME? . . . . .	479
[SENSe]:PVTime:MASK:LIST:TIME <time>, <time>, <time>, <time>, <time> . . . . .	480
[SENSe]:PVTime:MASK:LIST:TIME? . . . . .	480
[SENSe]:PVTime:MASK:LIST:UPPer:RELative <rel_power>, <rel_power>, <rel_power>, <rel_power>, <rel_power> . . . . .	480
[SENSe]:PVTime:MASK:LIST:UPPer:RELative? . . . . .	480
[SENSe]:PVTime:MASK:LIST:UPPer:TEST RELative   NONE, RELative   NONE, RELative   NONE, RELative   NONE, RELative   NONE, RELative   NONE . . . . .	482
[SENSe]:PVTime:MASK:LIST:UPPer:TEST? . . . . .	482
[SENSe]:PVTime:MASK:PREFerence A   B   C   D   E . . . . .	479
[SENSe]:PVTime:MASK:PREFerence? . . . . .	479
[SENSe]:PVTime:MASK:REFerence TRIGger   RISE   CENTer . . . . .	482
[SENSe]:PVTime:MASK:REFerence? . . . . .	482
[SENSe]:PVTime:MASK:REFerence[:OFFSet]:TIME <time> . . . . .	483
[SENSe]:PVTime:MASK:REFerence[:OFFSet]:TIME? . . . . .	483
[SENSe]:PVTime:SLOT[:TYPE] IDLE   ACTive . . . . .	483
[SENSe]:PVTime:SLOT[:TYPE]? . . . . .	483
[SENSe]:PVTime:TRIGger:SOURce EXTernal[1]   EXTernal2   FRAME   LINE   IF   IMMEDIATE   RFBurst . . . . .	484
[SENSe]:PVTime:TRIGger:SOURce? . . . . .	484
[SENSe]:RADio:CARRier:NUMBer SINGLE   MULTiple . . . . .	485
[SENSe]:RADio:CARRier:NUMBer? . . . . .	485
[SENSe]:RADio:DEVice BTS   MS . . . . .	485
[SENSe]:RADio:DEVice? . . . . .	485
[SENSe]:RADio:PLSubtype SUB0   SUB2 . . . . .	486
[SENSe]:RADio:PLSubtype? . . . . .	486

---

# List of Commands

[:SENSe]:RHO:ACODe AUTO   PREDeFined	487
[:SENSe]:RHO:ACODe?	487
[:SENSe]:RHO:ADC:RANGe AUTO   APEak   APLock   NONE   M6   P0   P6   P12   P18   P24	487
[:SENSe]:RHO:ADC:RANGe?	487
[:SENSe]:RHO:AVERAge:COUNT <integer>	488
[:SENSe]:RHO:AVERAge:COUNT?	488
[:SENSe]:RHO:AVERAge:TCONtrol EXPonential   REPeat	489
[:SENSe]:RHO:AVERAge:TCONtrol?	489
[:SENSe]:RHO:AVERAge[:STATe] OFF   ON   0   1	488
[:SENSe]:RHO:AVERAge[:STATe]?	489
[:SENSe]:RHO:CRATe <freq>	489
[:SENSe]:RHO:CRATe?	489
[:SENSe]:RHO:MCEStimator OFF   ON   0   1	490
[:SENSe]:RHO:MCEStimator?	490
[:SENSe]:RHO:PNOFfset <integer>	490
[:SENSe]:RHO:PNOFfset?	490
[:SENSe]:RHO:PREAmble:LENGth <integer>	490
[:SENSe]:RHO:PREAmble:LENGth:AUTO OFF   ON   0   1	491
[:SENSe]:RHO:PREAmble:LENGth:AUTO?	491
[:SENSe]:RHO:PREAmble:LENGth?	490
[:SENSe]:RHO:PREAmble:STATe OFF   ON   0   1	491
[:SENSe]:RHO:PREAmble:STATe?	491
[:SENSe]:RHO:SPECtrum INVert   NORMal	491
[:SENSe]:RHO:SPECtrum?	491
[:SENSe]:RHO:TRIGger:SOURce EXTernal[1]   External2   FRAMe   IF   IMMEDIATE   RFBurst	492
[:SENSe]:RHO:TRIGger:SOURce?	492
[:SENSe]:SEMAsk:AVERAge:COUNT <integer>	493
[:SENSe]:SEMAsk:AVERAge:COUNT?	493
[:SENSe]:SEMAsk:AVERAge:TCONtrol EXPonential   REPeat	493
[:SENSe]:SEMAsk:AVERAge:TCONtrol?	493
[:SENSe]:SEMAsk:AVERAge[:STATe] OFF   ON   0   1	493

---

## List of Commands

[:SENSe]:SEMAsk:AVERAge[:STATe]? .....	493
[:SENSe]:SEMAsk:BANDwidth[n]   BWIDth[n]:INTegration <freq> .....	494
[:SENSe]:SEMAsk:BANDwidth[n]   BWIDth[n]:INTegration? .....	494
[:SENSe]:SEMAsk:BANDwidth[n]   BWIDth[n]:RESolution <freq> .....	495
[:SENSe]:SEMAsk:BANDwidth[n]   BWIDth[n]:RESolution:AUTO OFF   ON   0   1 .....	495
[:SENSe]:SEMAsk:BANDwidth[n]   BWIDth[n]:RESolution:AUTO? .....	495
[:SENSe]:SEMAsk:BANDwidth[n]   BWIDth[n]:RESolution? .....	495
[:SENSe]:SEMAsk:BANDwidth   BWIDth:INTegration[m] <freq> .....	494
[:SENSe]:SEMAsk:BANDwidth   BWIDth:INTegration[m]? .....	494
[:SENSe]:SEMAsk:BANDwidth   BWIDth:RESolution[m] <freq> .....	495
[:SENSe]:SEMAsk:BANDwidth   BWIDth:RESolution[m]:AUTO OFF   ON   0   1 .....	495
[:SENSe]:SEMAsk:BANDwidth   BWIDth:RESolution[m]:AUTO? .....	495
[:SENSe]:SEMAsk:BANDwidth   BWIDth:RESolution[m]? .....	495
[:SENSe]:SEMAsk:DETEctor[:FUNCTion] AAVerage   POSitive .....	496
[:SENSe]:SEMAsk:DETEctor[:FUNCTion]? .....	496
[:SENSe]:SEMAsk:FREQuency:STEP[m] <freq> .....	497
[:SENSe]:SEMAsk:FREQuency:STEP[m]:AUTO OFF   ON   0   1 .....	497
[:SENSe]:SEMAsk:FREQuency:STEP[m]:AUTO? .....	498
[:SENSe]:SEMAsk:FREQuency:STEP[m]? .....	497
[:SENSe]:SEMAsk:FREQuency[n]:SPAN[m] <freq> .....	496
[:SENSe]:SEMAsk:FREQuency[n]:SPAN[m]? .....	496
[:SENSe]:SEMAsk:FREQuency[n]:STEP <freq> .....	497
[:SENSe]:SEMAsk:FREQuency[n]:STEP:AUTO OFF   ON   0   1 .....	497
[:SENSe]:SEMAsk:FREQuency[n]:STEP:AUTO? .....	497
[:SENSe]:SEMAsk:FREQuency[n]:STEP? .....	497
[:SENSe]:SEMAsk:OFFSet:LIST[m]:BANDwidth   BWIDth <res_bw>,<res_bw>,<res_bw>,<res_bw>,<res_bw> .....	498
[:SENSe]:SEMAsk:OFFSet:LIST[m]:BANDwidth   BWIDth:AUTO OFF   ON   0   1,OFF   ON   0   1,OFF   ON   0   1,OFF   ON   0   1,OFF   ON   0   1 .....	499
[:SENSe]:SEMAsk:OFFSet:LIST[m]:BANDwidth   BWIDth:AUTO? .....	499
[:SENSe]:SEMAsk:OFFSet:LIST[m]:BANDwidth   BWIDth:IMULti <integer>,<integer>,<integer>,<integer>,<integer> .....	500

---

# List of Commands

[:SENSe]:SEMAsk:OFFSet:LIST[m]:BANDwidth   BWIDth:IMULti? .....	.500
[:SENSe]:SEMAsk:OFFSet:LIST[m]:BANDwidth   BWIDth? .....	.498
[:SENSe]:SEMAsk:OFFSet:LIST[m]:FREQuency:STARt <f_offset>,<f_offset>,<f_offset>,<f_offset>,<f_offset> .....	.501
[:SENSe]:SEMAsk:OFFSet:LIST[m]:FREQuency:STARt? .....	.501
[:SENSe]:SEMAsk:OFFSet:LIST[m]:FREQuency:STEP <f_offset>,<f_offset>,<f_offset>,<f_offset>,<f_offset> .....	.502
[:SENSe]:SEMAsk:OFFSet:LIST[m]:FREQuency:STEP:AUTO OFF   ON   0   1,OFF   ON   0   1,OFF   ON   0   1,OFF   ON   0   1,OFF   ON   0   1 .....	.503
[:SENSe]:SEMAsk:OFFSet:LIST[m]:FREQuency:STEP:AUTO? .....	.503
[:SENSe]:SEMAsk:OFFSet:LIST[m]:FREQuency:STEP? .....	.502
[:SENSe]:SEMAsk:OFFSet:LIST[m]:FREQuency:STOP <f_offset>,<f_offset>,<f_offset>,<f_offset>,<f_offset> .....	.503
[:SENSe]:SEMAsk:OFFSet:LIST[m]:FREQuency:STOP? .....	.504
[:SENSe]:SEMAsk:OFFSet:LIST[m]:RATTenuation <rel_power>,<rel_power>,<rel_power>,<rel_power>,<rel_power> .....	.504
[:SENSe]:SEMAsk:OFFSet:LIST[m]:RATTenuation? .....	.504
[:SENSe]:SEMAsk:OFFSet:LIST[m]:SIDE BOTH   NEGative   POSitive, BOTH   NEGative   POSitive,BOTH   NEGative   POSitive, BOTH   NEGative   POSi- tive,BOTH   NEGative   POSitive. ....	.506
[:SENSe]:SEMAsk:OFFSet:LIST[m]:SIDE? .....	.506
[:SENSe]:SEMAsk:OFFSet:LIST[m]:STARt:ABSolute <abs_power>,<abs_power>,<abs_power>,<abs_power>,<abs_power> .....	.506
[:SENSe]:SEMAsk:OFFSet:LIST[M]:STARt:ABSolute? .....	.506
[:SENSe]:SEMAsk:OFFSet:LIST[m]:STARt:RCARrier <rel_power>,<rel_power>,<rel_power>,<rel_power>,<rel_power> .....	.507
[:SENSe]:SEMAsk:OFFSet:LIST[m]:STARt:RCARrier? .....	.508
[:SENSe]:SEMAsk:OFFSet:LIST[m]:STATe OFF   ON   0   1,OFF   ON   0   1,OFF   ON   0   1,OFF   ON   0   1,OFF   ON   0   1 .....	.509
[:SENSe]:SEMAsk:OFFSet:LIST[m]:STATe? .....	.509
[:SENSe]:SEMAsk:OFFSet:LIST[m]:STOP:ABSolute <abs_power>,<abs_power>,<abs_power>,<abs_power>,<abs_power> .....	.509
[:SENSe]:SEMAsk:OFFSet:LIST[m]:STOP:ABSolute:COUPle OFF   ON   0   1,OFF   ON   0   1,OFF   ON   0   1,OFF   ON   0   1,OFF   ON   0   1 .....	.511
[:SENSe]:SEMAsk:OFFSet:LIST[m]:STOP:ABSolute:COUPle? .....	.511

---

# List of Commands

[:SENSe]:SEMAsk:OFFSet:LIST[m]:STOP:ABSolute? . . . . .	509
[:SENSe]:SEMAsk:OFFSet:LIST[m]:STOP:RCARrier <rel_power>,<rel_power>,<rel_power>,<rel_power>,<rel_power> . . . . .	511
[:SENSe]:SEMAsk:OFFSet:LIST[m]:STOP:RCARrier:COUPle OFF   ON   0   1,OFF   ON   0   1,OFF   ON   0   1,OFF   ON   0   1,OFF   ON   0   1 . . . . .	513
[:SENSe]:SEMAsk:OFFSet:LIST[m]:STOP:RCARrier:COUPle? . . . . .	513
[:SENSe]:SEMAsk:OFFSet:LIST[m]:STOP:RCARrier? . . . . .	511
[:SENSe]:SEMAsk:OFFSet:LIST[m]:TEST ABSolute   AND   OR   RELative,ABSolute   AND   OR   RELative, ABSolute   AND   OR   RELative,ABSolute   AND   OR   RELative, ABSolute   AND   OR   RELative . . . . .	513
[:SENSe]:SEMAsk:OFFSet:LIST[m]:TEST? . . . . .	514
[:SENSe]:SEMAsk:OFFSet[n]:LIST:BANDwidth   BWIDth <res_bw>,<res_bw>,<res_bw>,<res_bw>,<res_bw> . . . . .	498
[:SENSe]:SEMAsk:OFFSet[n]:LIST:BANDwidth   BWIDth:AUTO OFF   ON   0   1,OFF   ON   0   1,OFF   ON   0   1,OFF   ON   0   1,OFF   ON   0   1 . . . . .	499
[:SENSe]:SEMAsk:OFFSet[n]:LIST:BANDwidth   BWIDth:AUTO? . . . . .	499
[:SENSe]:SEMAsk:OFFSet[n]:LIST:BANDwidth   BWIDth:IMULti <integer>,<integer>,<integer>,<integer>,<integer> . . . . .	500
[:SENSe]:SEMAsk:OFFSet[n]:LIST:BANDwidth   BWIDth:IMULti? . . . . .	500
[:SENSe]:SEMAsk:OFFSet[n]:LIST:BANDwidth   BWIDth? . . . . .	498
[:SENSe]:SEMAsk:OFFSet[n]:LIST:FREQuency:STARt <f_offset>,<f_offset>,<f_offset>,<f_offset>,<f_offset> . . . . .	501
[:SENSe]:SEMAsk:OFFSet[n]:LIST:FREQuency:STARt? . . . . .	501
[:SENSe]:SEMAsk:OFFSet[n]:LIST:FREQuency:STEP <f_offset>,<f_offset>,<f_offset>,<f_offset>,<f_offset> . . . . .	502
[:SENSe]:SEMAsk:OFFSet[n]:LIST:FREQuency:STEP:AUTO OFF   ON   0   1,OFF   ON   0   1,OFF   ON   0   1,OFF   ON   0   1,OFF   ON   0   1 . . . . .	502
[:SENSe]:SEMAsk:OFFSet[n]:LIST:FREQuency:STEP:AUTO? . . . . .	503
[:SENSe]:SEMAsk:OFFSet[n]:LIST:FREQuency:STEP? . . . . .	502
[:SENSe]:SEMAsk:OFFSet[n]:LIST:FREQuency:STOP <f_offset>,<f_offset>,<f_offset>,<f_offset>,<f_offset> . . . . .	503
[:SENSe]:SEMAsk:OFFSet[n]:LIST:FREQuency:STOP? . . . . .	503
[:SENSe]:SEMAsk:OFFSet[n]:LIST:RATTenuation <rel_power>,<rel_power>,<rel_power>,<rel_power>,<rel_power> . . . . .	504
[:SENSe]:SEMAsk:OFFSet[n]:LIST:RATTenuation? . . . . .	504

---

# List of Commands

[:SENSe]:SEMAsk:OFFSet[n]:LIST:SIDE BOTH   NEGative   POSitive, BOTH   NEGative   POSitive,BOTH   NEGative   POSitive, BOTH   NEGative   POSi- tive,BOTH   NEGative   POSitive. . . . .	.505
[:SENSe]:SEMAsk:OFFSet[n]:LIST:SIDE?. . . . .	.505
[:SENSe]:SEMAsk:OFFSet[n]:LIST:START:ABSolute <abs_power>,<abs_power>,<abs_power>,<abs_power>,<abs_power> . . . . .	.506
[:SENSe]:SEMAsk:OFFSet[n]:LIST:START:ABSolute? . . . . .	.506
[:SENSe]:SEMAsk:OFFSet[n]:LIST:START:RCARrier <rel_power>,<rel_power>,<rel_power>,<rel_power>,<rel_power>. . . . .	.507
[:SENSe]:SEMAsk:OFFSet[n]:LIST:START:RCARrier? . . . . .	.507
[:SENSe]:SEMAsk:OFFSet[n]:LIST:STATe OFF   ON   0   1,OFF   ON   0   1,OFF   ON   0   1,OFF   ON   0   1,OFF   ON   0   1 . . . . .	.508
[:SENSe]:SEMAsk:OFFSet[n]:LIST:STATe? . . . . .	.509
[:SENSe]:SEMAsk:OFFSet[n]:LIST:STOP:ABSolute <abs_power>,<abs_power>,<abs_power>,<abs_power>,<abs_power> . . . . .	.509
[:SENSe]:SEMAsk:OFFSet[n]:LIST:STOP:ABSolute:COUPle OFF   ON   0   1,OFF   ON   0   1,OFF   ON   0   1,OFF   ON   0   1,OFF   ON   0   1 . . . . .	.510
[:SENSe]:SEMAsk:OFFSet[n]:LIST:STOP:ABSolute:COUPle? . . . . .	.510
[:SENSe]:SEMAsk:OFFSet[n]:LIST:STOP:ABSolute? . . . . .	.509
[:SENSe]:SEMAsk:OFFSet[n]:LIST:STOP:RCARrier <rel_power>,<rel_power>,<rel_power>,<rel_power>,<rel_power>. . . . .	.511
[:SENSe]:SEMAsk:OFFSet[n]:LIST:STOP:RCARrier:COUPle OFF   ON   0   1,OFF   ON   0   1,OFF   ON   0   1,OFF   ON   0   1,OFF   ON   0   1 . . . . .	.512
[:SENSe]:SEMAsk:OFFSet[n]:LIST:STOP:RCARrier:COUPle? . . . . .	.512
[:SENSe]:SEMAsk:OFFSet[n]:LIST:STOP:RCARrier? . . . . .	.511
[:SENSe]:SEMAsk:OFFSet[n]:LIST:TEST ABSolute   AND   OR   RELative,ABSolute   AND   OR   RELative, ABSolute   AND   OR   RELative,ABSolute   AND   OR   RELative, ABSolute   AND   OR   RELative. . . . .	.513
[:SENSe]:SEMAsk:OFFSet[n]:LIST:TEST? . . . . .	.513
[:SENSe]:SEMAsk:REGion:LIST:BANDwidth   BWIDth <res_bw>,<res_bw>,<res_bw>,<res_bw>,<res_bw> . . . . .	.515
[:SENSe]:SEMAsk:REGion:LIST:BANDwidth   BWIDth:AUTO OFF   ON   0   1,OFF   ON   0   1,OFF   ON   0   1,OFF   ON   0   1,OFF   ON   0   1 . . . . .	.516
[:SENSe]:SEMAsk:REGion:LIST:BANDwidth   BWIDth:AUTO? . . . . .	.516
[:SENSe]:SEMAsk:REGion:LIST:BANDwidth   BWIDth? . . . . .	.515

---

# List of Commands

[:SENSe]:SEMAsk:REGion:LIST:FREQuency:StARt <f_region>,<f_region>,<f_region>,<f_region>,<f_region> .....	516
[:SENSe]:SEMAsk:REGion:LIST:FREQuency:StARt? .....	516
[:SENSe]:SEMAsk:REGion:LIST:FREQuency:StEP <f_region>,<f_region>,<f_region>,<f_region>,<f_region> .....	517
[:SENSe]:SEMAsk:REGion:LIST:FREQuency:StEP:AUTO OFF   ON   0   1,OFF   ON   0   1,OFF   ON   0   1,OFF   ON   0   1,OFF   ON   0   1 .....	518
[:SENSe]:SEMAsk:REGion:LIST:FREQuency:StEP:AUTO? .....	518
[:SENSe]:SEMAsk:REGion:LIST:FREQuency:StEP? .....	517
[:SENSe]:SEMAsk:REGion:LIST:FREQuency:StOP <f_region>,<f_region>,<f_region>,<f_region>,<f_region> .....	519
[:SENSe]:SEMAsk:REGion:LIST:FREQuency:StOP? .....	519
[:SENSe]:SEMAsk:REGion:LIST:RAttenuation <rel_power>,<rel_power>,<rel_power>,<rel_power>,<rel_power> .....	519
[:SENSe]:SEMAsk:REGion:LIST:RAttenuation? .....	519
[:SENSe]:SEMAsk:REGion:LIST:StARt:ABSolute <abs_power>,<abs_power> .....	520
[:SENSe]:SEMAsk:REGion:LIST:StARt:ABSolute? .....	521
[:SENSe]:SEMAsk:REGion:LIST:StARt:RCARrier <rel_power>,<rel_power>,<rel_power>,<rel_power>,<rel_power> .....	521
[:SENSe]:SEMAsk:REGion:LIST:StARt:RCARrier? .....	521
[:SENSe]:SEMAsk:REGion:LIST:StAte OFF   ON   0   1,OFF   ON   0   1,OFF   ON   0   1,OFF   ON   0   1,OFF   ON   0   1 .....	522
[:SENSe]:SEMAsk:REGion:LIST:StAte? .....	522
[:SENSe]:SEMAsk:REGion:LIST:StOP:ABSolute <abs_power>,<abs_power>,<abs_power>,<abs_power>,<abs_power> .....	523
[:SENSe]:SEMAsk:REGion:LIST:StOP:ABSolute? .....	523
[:SENSe]:SEMAsk:REGion:LIST:StOP:RCARrier <rel_power>,<rel_power>,<rel_power>,<rel_power>,<rel_power> .....	525
[:SENSe]:SEMAsk:REGion:LIST:StOP:RCARrier:COUple OFF   ON   0   1,OFF   ON   0   1,OFF   ON   0   1,OFF   ON   0   1,OFF   ON   0   1 .....	526
[:SENSe]:SEMAsk:REGion:LIST:StOP:RCARrier:COUple? .....	526
[:SENSe]:SEMAsk:REGion:LIST:StOP:RCARrier? .....	525
[:SENSe]:SEMAsk:REGion:LIST:TEST ABSolute   AND   OR   RELative,ABSolute   AND   OR   RELative, ABSolute   AND   OR   RELative,ABSolute   AND   OR   RELative,	

---

# List of Commands

ABSolute   AND   OR   RELative . . . . .	526
[:SENSe]:SEMAsk:REGion:LIST:TEST? . . . . .	526
[:SENSe]:SEMAsk:REGion[n]:LIST:BANDwidth   BWIDth <res_bw>,<res_bw>,<res_bw>,<res_bw>,<res_bw> . . . . .	515
[:SENSe]:SEMAsk:REGion[n]:LIST:BANDwidth   BWIDth:AUTO OFF   ON   0   1,OFF   ON   0   1,OFF   ON   0   1,OFF   ON   0   1,OFF   ON   0   1 . . . . .	515
[:SENSe]:SEMAsk:REGion[n]:LIST:BANDwidth   BWIDth:AUTO? . . . . .	516
[:SENSe]:SEMAsk:REGion[n]:LIST:BANDwidth   BWIDth? . . . . .	515
[:SENSe]:SEMAsk:REGion[n]:LIST:FREQuency:STARt <f_region>,<f_region>,<f_region>,<f_region>,<f_region> . . . . .	516
[:SENSe]:SEMAsk:REGion[n]:LIST:FREQuency:STARt? . . . . .	516
[:SENSe]:SEMAsk:REGion[n]:LIST:FREQuency:STEP <f_region>,<f_region>,<f_region>,<f_region>,<f_region> . . . . .	517
[:SENSe]:SEMAsk:REGion[n]:LIST:FREQuency:STEP:AUTO OFF   ON   0   1,OFF   ON   0   1,OFF   ON   0   1,OFF   ON   0   1,OFF   ON   0   1 . . . . .	518
[:SENSe]:SEMAsk:REGion[n]:LIST:FREQuency:STEP:AUTO? . . . . .	518
[:SENSe]:SEMAsk:REGion[n]:LIST:FREQuency:STEP? . . . . .	517
[:SENSe]:SEMAsk:REGion[n]:LIST:FREQuency:STOP <f_region>,<f_region>,<f_region>,<f_region>,<f_region> . . . . .	518
[:SENSe]:SEMAsk:REGion[n]:LIST:FREQuency:STOP? . . . . .	519
[:SENSe]:SEMAsk:REGion[n]:LIST:RATTenuation <rel_power>,<rel_power>,<rel_power>,<rel_power>,<rel_power> . . . . .	519
[:SENSe]:SEMAsk:REGion[n]:LIST:RATTenuation? . . . . .	519
[:SENSe]:SEMAsk:REGion[n]:LIST:STARt:ABSolute <abs_power>,<abs_power> . . . . .	520
[:SENSe]:SEMAsk:REGion[n]:LIST:STARt:ABSolute? . . . . .	520
[:SENSe]:SEMAsk:REGion[n]:LIST:STARt:RCARrier <rel_power>,<rel_power>,<rel_power>,<rel_power>,<rel_power> . . . . .	521
[:SENSe]:SEMAsk:REGion[n]:LIST:STARt:RCARrier? . . . . .	521
[:SENSe]:SEMAsk:REGion[n]:LIST:STATe OFF   ON   0   1,OFF   ON   0   1,OFF   ON   0   1,OFF   ON   0   1,OFF   ON   0   1 . . . . .	522
[:SENSe]:SEMAsk:REGion[n]:LIST:STATe? . . . . .	522
[:SENSe]:SEMAsk:REGion[n]:LIST:STOP:ABSolute <abs_power>,<abs_power>,<abs_power>,<abs_power>,<abs_power> . . . . .	523
[:SENSe]:SEMAsk:REGion[n]:LIST:STOP:ABSolute:COUPLE	



# List of Commands

OFF   ON   0   1, OFF   ON   0   1	524
[:SENSe]:SEMAsk:REGion[n]:LIST:STOP:ABSolute:COUPle?	524
[:SENSe]:SEMAsk:REGion[n]:LIST:STOP:ABSolute?	523
[:SENSe]:SEMAsk:REGion[n]:LIST:STOP:RCARrier <rel_power>, <rel_power>, <rel_power>, <rel_power>, <rel_power>	525
[:SENSe]:SEMAsk:REGion[n]:LIST:STOP:RCARrier:COUPle OFF   ON   0   1, OFF   ON   0   1, OFF   ON   0   1, OFF   ON   0   1, OFF   ON   0   1	526
[:SENSe]:SEMAsk:REGion[n]:LIST:STOP:RCARrier:COUPle?	526
[:SENSe]:SEMAsk:REGion[n]:LIST:STOP:RCARrier?	525
[:SENSe]:SEMAsk:REGion[n]:LIST:TEST ABSolute   AND   OR   RELative, ABSolute   AND   OR   RELative, ABSolute   AND   OR   RELative, ABSolute   AND   OR   RELative, ABSolute   AND   OR   RELative	526
[:SENSe]:SEMAsk:REGion[n]:LIST:TEST?	526
[:SENSe]:SEMAsk:SEGMENT OFFSet   REGion	527
[:SENSe]:SEMAsk:SEGMENT:TYPE ACPr   SEMAsk	528
[:SENSe]:SEMAsk:SEGMENT:TYPE?	528
[:SENSe]:SEMAsk:SEGMENT?	527
[:SENSe]:SEMAsk:SWEep:TIME <time>   <no. of chips>	528
[:SENSe]:SEMAsk:SWEep:TIME:OFFSet <time>   <no. of chips>	528
[:SENSe]:SEMAsk:SWEep:TIME:OFFSet?	528
[:SENSe]:SEMAsk:SWEep:TIME?	528
[:SENSe]:SEMAsk:TRIGger:SOURce EXTernal[1]   EXTernal2   FRAME   IMMEDIATE   LINE	529
[:SENSe]:SEMAsk:TRIGger:SOURce?	529
[:SENSe]:SEMAsk:TYPE PSDRef   TPreF	529
[:SENSe]:SEMAsk:TYPE?	529
[:SENSe]:SPECtrum:ACQuisition:PACKing AUTO   LONG   MEDIUM   SHORT	531
[:SENSe]:SPECtrum:ACQuisition:PACKing?	531
[:SENSe]:SPECtrum:ADC:DITHer[:STATe] AUTO   ON   OFF   2   1   0	531
[:SENSe]:SPECtrum:ADC:DITHer[:STATe]?	531
[:SENSe]:SPECtrum:ADC:RANGe AUTO   APEak   APLOCK   M6   P0   P6   P12   P18   P24	531
[:SENSe]:SPECtrum:ADC:RANGe AUTO   APEak   APLOCK   NONE   P0   P6   P12   P18	532
[:SENSe]:SPECtrum:ADC:RANGe?	532

---

# List of Commands

[:SENSe]:SPECTrum:AVERAge:CLEAr . . . . .	.533
[:SENSe]:SPECTrum:AVERAge:COUNT <integer> . . . . .	.533
[:SENSe]:SPECTrum:AVERAge:COUNT? . . . . .	.533
[:SENSe]:SPECTrum:AVERAge:TCONtrol EXPonential   REPeat. . . . .	.534
[:SENSe]:SPECTrum:AVERAge:TCONtrol? . . . . .	.534
[:SENSe]:SPECTrum:AVERAge:TYPE LOG   MAXimum   MINimum   RMS   SCALAr . . . . .	.534
[:SENSe]:SPECTrum:AVERAge:TYPE? . . . . .	.534
[:SENSe]:SPECTrum:AVERAge[:STATe] OFF   ON   0   1 . . . . .	.534
[:SENSe]:SPECTrum:AVERAge[:STATe]? . . . . .	.534
[:SENSe]:SPECTrum:BANdwidth   BWIDth:IF:AUTO OFF   ON   0   1 . . . . .	.535
[:SENSe]:SPECTrum:BANdwidth   BWIDth:IF:AUTO? . . . . .	.535
[:SENSe]:SPECTrum:BANdwidth   BWIDth:IF:FLATness OFF   ON   0   1. . . . .	.535
[:SENSe]:SPECTrum:BANdwidth   BWIDth:IF:FLATness? . . . . .	.535
[:SENSe]:SPECTrum:BANdwidth   BWIDth:PADC OFF   ON   0   1 . . . . .	.536
[:SENSe]:SPECTrum:BANdwidth   BWIDth:PADC? . . . . .	.536
[:SENSe]:SPECTrum:BANdwidth   BWIDth:PFFT:TYPE FLAT   GAUSsian. . . . .	.537
[:SENSe]:SPECTrum:BANdwidth   BWIDth:PFFT:TYPE? . . . . .	.537
[:SENSe]:SPECTrum:BANdwidth   BWIDth:PFFT[:SIZE] <freq> . . . . .	.536
[:SENSe]:SPECTrum:BANdwidth   BWIDth:PFFT[:SIZE]? . . . . .	.536
[:SENSe]:SPECTrum:BANdwidth   BWIDth[:RESolution] <freq> . . . . .	.537
[:SENSe]:SPECTrum:BANdwidth   BWIDth[:RESolution]:AUTO OFF   ON   0   1 . . . . .	.538
[:SENSe]:SPECTrum:BANdwidth   BWIDth[:RESolution]:AUTO? . . . . .	.538
[:SENSe]:SPECTrum:BANdwidth   BWIDth[:RESolution]? . . . . .	.537
[:SENSe]:SPECTrum:DECimate[:FACTor] <integer> . . . . .	.538
[:SENSe]:SPECTrum:DECimate[:FACTor]? . . . . .	.538
[:SENSe]:SPECTrum:FFT:LENGth <integer> . . . . .	.539
[:SENSe]:SPECTrum:FFT:LENGth:AUTO OFF   ON   0   1 . . . . .	.539
[:SENSe]:SPECTrum:FFT:LENGth:AUTO? . . . . .	.539
[:SENSe]:SPECTrum:FFT:LENGth? . . . . .	.539
[:SENSe]:SPECTrum:FFT:RBWPoints <real> . . . . .	.540
[:SENSe]:SPECTrum:FFT:RBWPoints? . . . . .	.540

---

## List of Commands

[:SENSe]:SPECTrum:FFT:WINDow:DELay <real> .....	540
[:SENSe]:SPECTrum:FFT:WINDow:DELay? .....	540
[:SENSe]:SPECTrum:FFT:WINDow:LENGth <integer> .....	541
[:SENSe]:SPECTrum:FFT:WINDow:LENGth? .....	541
[:SENSe]:SPECTrum:FFT:WINDow[:TYPE] BH4Tap   BLACKman   FLATtop   GAUSSian   HAM- Ming   HANNing   KB70   KB90   KB110   UNIFORM. ....	541
[:SENSe]:SPECTrum:FFT:WINDow[:TYPE]? .....	541
[:SENSe]:SPECTrum:FREQuency:SPAN <freq> .....	542
[:SENSe]:SPECTrum:FREQuency:SPAN? .....	542
[:SENSe]:SPECTrum:SWEep:TIME:AUTO OFF   ON   0   1 .....	543
[:SENSe]:SPECTrum:SWEep:TIME:AUTO .....	543
[:SENSe]:SPECTrum:SWEep:TIME? .....	542
[:SENSe]:SPECTrum:SWEep:TIME[:VALue] <time> .....	542
[:SENSe]:SPECTrum:TRIGger:SOURce? .....	543
[:SENSe]:SPECTrum:TRIGger:SOURce EXTernal[1]   EXTernal2   FRAME   IF   LINE   IMMEDIATE   RFBurst. ....	543
[:SENSe]:TCDPower:ACODE AUTO   COMBination   PREDefined .....	549
[:SENSe]:TCDPower:ACODE:ACK OFF   ON   0   1 .....	546
[:SENSe]:TCDPower:ACODE:ACK? .....	546
[:SENSe]:TCDPower:ACODE:ACKDsc OFF   ON   0   1 .....	548
[:SENSe]:TCDPower:ACODE:ACKDsc? .....	548
[:SENSe]:TCDPower:ACODE:APILot OFF   ON   0   1 .....	548
[:SENSe]:TCDPower:ACODE:APILot? .....	548
[:SENSe]:TCDPower:ACODE:DATA:SUB2 B4   Q4   Q2   Q4Q2   E4E2   OFF .....	549
[:SENSe]:TCDPower:ACODE:DATA:SUB2? .....	549
[:SENSe]:TCDPower:ACODE:DRC OFF   ON   0   1 .....	547
[:SENSe]:TCDPower:ACODE:DRC? .....	547
[:SENSe]:TCDPower:ACODE:PILot OFF   ON   0   1 .....	546
[:SENSe]:TCDPower:ACODE:PILot OFF   ON   0   1 .....	547
[:SENSe]:TCDPower:ACODE:PILot? .....	546
[:SENSe]:TCDPower:ACODE:PILot? .....	547

---

# List of Commands

[:SENSe]:TCDPower:ACODE:RRI OFF   ON   0   1	.548
[:SENSe]:TCDPower:ACODE:RRI?	.548
[:SENSe]:TCDPower:ACODE?	.549
[:SENSe]:TCDPower:ADC:RANGe AUTO   APEak   APLock   M6   P0   P6   P12   P18   P24	.545
[:SENSe]:TCDPower:ADC:RANGe AUTO   APEak   APLock   NONE   P0   P6   P12   P18   P24   M6	.550
[:SENSe]:TCDPower:ADC:RANGe?	.545
[:SENSe]:TCDPower:ADC:RANGe?	.550
[:SENSe]:TCDPower:CAPTure:TIME <integer>	.551
[:SENSe]:TCDPower:CAPTure:TIME?	.551
[:SENSe]:TCDPower:CRATe <freq>	.551
[:SENSe]:TCDPower:CRATe?	.551
[:SENSe]:TCDPower:SPECTrum NORMAL   INVert	.553
[:SENSe]:TCDPower:SPECTrum?	.553
[:SENSe]:TCDPower:SSLot:NUMBER <integer>	.553
[:SENSe]:TCDPower:SSLot:NUMBER?	.553
[:SENSe]:TCDPower:SSLot[:STATe] OFF   ON   0   1	.553
[:SENSe]:TCDPower:SSLot[:STATe]?	.553
[:SENSe]:TCDPower:SYNC:ILCMask <integer>	.554
[:SENSe]:TCDPower:SYNC:ILCMask?	.554
[:SENSe]:TCDPower:SYNC:QLCMask <integer>	.554
[:SENSe]:TCDPower:SYNC:QLCMask?	.554
[:SENSe]:TCDPower:TRIGger:SOURce EXTernal[1]   EXTernal2   IMMEDIATE   RFBurst   IF   FRAME	.552
[:SENSe]:TCDPower:TRIGger:SOURce?	.552
[:SENSe]:TRHO:ACODE AUTO   COMBination   PREDefined	.556
[:SENSe]:TRHO:ACODE:ACK OFF   ON   0   1	.557
[:SENSe]:TRHO:ACODE:ACK OFF   ON   0   1	.559
[:SENSe]:TRHO:ACODE:ACK?	.557
[:SENSe]:TRHO:ACODE:ACK?	.559
[:SENSe]:TRHO:ACODE:ACKDsc OFF   ON   0   1	.558
[:SENSe]:TRHO:ACODE:ACKDsc?	.558

---

## List of Commands

[:SENSe]:TRHO:ACODe:APILot OFF   ON   0   1 . . . . .	558
[:SENSe]:TRHO:ACODe:APILot? . . . . .	558
[:SENSe]:TRHO:ACODe:DATA OFF   ON   0   1 . . . . .	557
[:SENSe]:TRHO:ACODe:DATA:SUB2 B4   Q4   Q2   Q4Q2   E4E2   OFF . . . . .	559
[:SENSe]:TRHO:ACODe:DATA:SUB2? . . . . .	559
[:SENSe]:TRHO:ACODe:DATA? . . . . .	557
[:SENSe]:TRHO:ACODe:DRC OFF   ON   0   1 . . . . .	557
[:SENSe]:TRHO:ACODe:DRC? . . . . .	557
[:SENSe]:TRHO:ACODe:PILot OFF   ON   0   1 . . . . .	556
[:SENSe]:TRHO:ACODe:PILot? . . . . .	556
[:SENSe]:TRHO:ACODe:RRI OFF   ON   0   1 . . . . .	558
[:SENSe]:TRHO:ACODe:RRI? . . . . .	558
[:SENSe]:TRHO:ACODe? . . . . .	556
[:SENSe]:TRHO:ADC:RANGe AUTO   APEak   APLock   NONE   P0   P6   P12   P18   P24   M6 . . . . .	559
[:SENSe]:TRHO:ADC:RANGe? . . . . .	560
[:SENSe]:TRHO:AVERAge:COUNt <integer> . . . . .	561
[:SENSe]:TRHO:AVERAge:COUNt? . . . . .	561
[:SENSe]:TRHO:AVERAge:SLOT HS1   HS2   FS . . . . .	562
[:SENSe]:TRHO:AVERAge:SLOT? . . . . .	562
[:SENSe]:TRHO:AVERAge:TCONtrol EXPonential   REPeat . . . . .	561
[:SENSe]:TRHO:AVERAge:TCONtrol? . . . . .	561
[:SENSe]:TRHO:AVERAge[:STATe] OFF   ON   0   1 . . . . .	561
[:SENSe]:TRHO:AVERAge[:STATe]? . . . . .	561
[:SENSe]:TRHO:CRATe <freq> . . . . .	562
[:SENSe]:TRHO:CRATe? . . . . .	562
[:SENSe]:TRHO:FERRor:TRANge WIDE   NORMal   NARRow . . . . .	563
[:SENSe]:TRHO:FERRor:TRANge? . . . . .	563
[:SENSe]:TRHO:IQOFfset:INCLude OFF   ON   0   1 . . . . .	563
[:SENSe]:TRHO:IQOFfset:INCLude? . . . . .	563
[:SENSe]:TRHO:MCEStimator OFF   ON   0   1 . . . . .	564
[:SENSe]:TRHO:MCEStimator:TIMing CHANnel   GLOBal . . . . .	565

---

# List of Commands

[:SENSe]:TRHO:MCEStimator:TIMing? .....	.565
[:SENSe]:TRHO:MCEStimator? .....	.564
[:SENSe]:TRHO:SPECtrum NORMal   INVert. ....	.565
[:SENSe]:TRHO:SPECtrum? .....	.565
[:SENSe]:TRHO:SSLot:NUMBer <integer> .....	.565
[:SENSe]:TRHO:SSLot:NUMBer? .....	.566
[:SENSe]:TRHO:SSLot[:STATe] OFF   ON   0   1 .....	.566
[:SENSe]:TRHO:SSLot[:STATe]? .....	.566
[:SENSe]:TRHO:SYNC:ILCMask <long_integer> .....	.566
[:SENSe]:TRHO:SYNC:ILCMask? .....	.566
[:SENSe]:TRHO:SYNC:QLCMask <long_integer> .....	.567
[:SENSe]:TRHO:SYNC:QLCMask? .....	.567
[:SENSe]:TRHO:TRIGger:SOURce EXTernal[1]   EXTernal2   IMMEDIATE   RFBurst   IF   FRAME .....	.567
[:SENSe]:TRHO:TRIGger:SOURce? .....	.567
[:SENSe]:WAVeform:ACQuisition:PACKing AUTO   LONG   MEdium   SHORt .....	.569
[:SENSe]:WAVeform:ACQuisition:PACKing? .....	.569
[:SENSe]:WAVeform:ADC:DITHer[:STATe] OFF   ON   0   1 .....	.569
[:SENSe]:WAVeform:ADC:DITHer[:STATe]? .....	.569
[:SENSe]:WAVeform:ADC:FILTer[:STATe] OFF   ON   0   1 .....	.569
[:SENSe]:WAVeform:ADC:FILTer[:STATe]? .....	.569
[:SENSe]:WAVeform:ADC:RANGe AUTO   APeak   APLock   GROund   M6   P0   P6   P12   P18   P24 .....	.570
[:SENSe]:WAVeform:ADC:RANGe AUTO   APeak   APLock   GROund   NONE   P0   P6   P12   P18 .....	.570
[:SENSe]:WAVeform:ADC:RANGe? .....	.570
[:SENSe]:WAVeform:APERture? .....	.571
[:SENSe]:WAVeform:AVERage:COUNT <integer> .....	.571
[:SENSe]:WAVeform:AVERage:COUNT? .....	.571
[:SENSe]:WAVeform:AVERage:TCONtrol EXPONential   REPeat .....	.572
[:SENSe]:WAVeform:AVERage:TCONtrol? .....	.572
[:SENSe]:WAVeform:AVERage:TYPE LOG   MAXimum   MINimum   RMS   SCALar .....	.572
[:SENSe]:WAVeform:AVERage:TYPE? .....	.572

---

## List of Commands

[[:SENSe]:WAVeform:AVERage[:STATe] OFF   ON   0   1 . . . . .	571
[[:SENSe]:WAVeform:AVERage[:STATe]? . . . . .	571
[[:SENSe]:WAVeform:BANDwidth:RESolution]:ACTual? . . . . .	573
[[:SENSe]:WAVeform:BANDwidth   BWIDth[:RESolution] <freq> . . . . .	573
[[:SENSe]:WAVeform:BANDwidth   BWIDth[:RESolution]:TYPE FLATtop   GAUSSian . . . . .	574
[[:SENSe]:WAVeform:BANDwidth   BWIDth[:RESolution]:TYPE? . . . . .	574
[[:SENSe]:WAVeform:BANDwidth   BWIDth[:RESolution]? . . . . .	573
[[:SENSe]:WAVeform:DECimate:STATe OFF   ON   0   1 . . . . .	575
[[:SENSe]:WAVeform:DECimate:STATe? . . . . .	575
[[:SENSe]:WAVeform:DECimate[:FACTor] <integer> . . . . .	574
[[:SENSe]:WAVeform:DECimate[:FACTor]? . . . . .	574
[[:SENSe]:WAVeform:SWEep:TIME <time> . . . . .	575
[[:SENSe]:WAVeform:SWEep:TIME? . . . . .	575
[[:SENSe]:WAVeform:TRIGger:SOURce EXTernal[1]   EXTernal2   FRAME   IF   IMMEDIATE   LINE   RFBurst . . . . .	575
[[:SENSe]:WAVeform:TRIGger:SOURce? . . . . .	575





---

# 1 Introduction

This chapter provides overall information on the 1xEV-DO communications system and describes 1xEV-DO measurements made by the analyzer. Installation instructions for adding this option to your analyzer are provided in this section, in case you purchased this option separately.

---

## What Does the Agilent PSA Series and VSA E4406A Option 204 Do?

This instrument can help determine if a 1xEV-DO transmitter is working correctly. When measurement personality Option 204 is installed, the instrument makes measurements using the methods and limits defined in the following 3GPP2 standards:

3GPP2 C.S0024-A cdma2000 High Rate Packet Data Air Interface Specification v.1.0 (2004-03)

3GPP2 C.S0032-0 Recommended Minimum Performance Standards for cdma2000 High Rate Packet Data Access Network v.2.0 (2004-01)

3GPP2 C.S0033-0 Recommended Minimum Performance Standards for cdma2000 High Rate Packet Data Access Terminal v.2.0 (2004-01)

The detailed measurement results displayed by the instrument allow you to analyze 1xEV-DO system performance. You may alter the measurement parameters for specialized analysis.

For infrastructure test, the instrument will test base station transmitters in a non-interfering manner by means of a coupler or power splitter.

This instrument makes the following measurements:

- Channel Power
- Intermodulation
- Power versus Time
- Spurious Emissions and ACP
- Occupied Bandwidth
- Code Domain Power
- Modulation Accuracy (Composite Rho)
- QPSK EVM
- Power Statistics CCDF
- Spectrum (Frequency Domain)
- Waveform (Time Domain)

---

## Installing Optional Measurement Personalities

When you install a measurement personality, you need to follow a three step process:

1. Determine whether your memory capacity is sufficient to contain all the options you want to load. If not, decide which options you want to install now, and consider upgrading your memory. Details follow in [“Do You Have Enough Memory to Load All Your Personality Options?”](#) on page 43.
2. Install the measurement personality firmware into the instrument memory. Details follow in [“Loading an Optional Measurement Personality”](#) on page 47.
3. Enter a license key that activates the measurement personality. Details follow in [“Obtaining and Installing a License Key”](#) on page 48.

Adding measurement personalities requires the purchase of a retrofit kit for the desired option. The retrofit kit contains the measurement personality firmware and an entitlement certificate that is used to generate a license key from the internet website. A separate license key is required for each option on a specific instrument serial number and host ID.

For the latest information on Agilent Spectrum Analyzer options and upgrade kits, visit the following Internet URL:

[http://www.agilent.com/find/sa\\_upgrades](http://www.agilent.com/find/sa_upgrades)

### Do You Have Enough Memory to Load All Your Personality Options?

If you do not have memory limitations then you can skip ahead to the next section [“Loading an Optional Measurement Personality”](#) on page 47. If after installing your options you get error messages relating to memory issues, you can return to this section to learn more about how to optimize your configuration.

If you have 64 MBytes of memory installed in your instrument, you should have enough memory to install at least four optional personalities, with plenty of memory for data and states.

The optional measurement personalities require different amounts of memory. So the number of personalities that you can load varies. This is also impacted by how much data you need to save. If you are having memory errors you must swap the applications in/out of memory as needed. If you only have 48 MBytes of memory, you can upgrade your hardware to 64 MBytes.

To see the size of your installed memory for PSA Series Spectrum Analyzers:

1. Ensure that the spectrum analyzer is in spectrum analyzer mode because this can affect the screen size.
2. Press the **System** key, **MORE (1 of 3)**, and **Show Hdwr** keys.
3. Read **Flash Memory size** on the last line of the table.

<b>PSA Flash Memory Size</b>	<b>Available Memory With No Options</b>	<b>Available Memory With Option B7J and/or Option 122 or 140</b>
64 Mbytes	32.5 MBytes	30.0 MBytes
48 Mbytes	16.9 MBytes	14.3 MBytes

To see the size of your installed memory for E4406A Transmitter Testers:

1. Press the **System** key, **MORE (1 of 3)**, and **MORE (2 of 3)** keys.
2. Read the **File System Key** - The total of the entries for **Used** and **Free** memory will total the installed flash memory, either 48 or 64 MBytes.

If you have 48 MBytes of memory, and you want to install more than 3 optional personalities, you may need to manage your memory resources. The following section, [“How to Predict Your Memory Requirements” on page 45](#), will help you decide how to configure your installed options to provide optimal operation.

## How to Predict Your Memory Requirements

If you plan to install many optional personalities, you should review your memory requirements, so you can determine whether you have enough memory. There is an Agilent “Memory Calculator” available online that can help you do this, or you can make a calculated approximation using the information that follows. You will need to know your instrument’s installed memory size as determined in the previous section and then select your desired applications.

For E4406A see: <http://sa.tm.agilent.com/E4406A/memory/>

For PSA Series see: [http://www.agilent.com/find/psa\\_firmware](http://www.agilent.com/find/psa_firmware)

For PSA select the “Memory Calculator” link. You can try any combination of available personalities to see if your desired configuration is compatible with your installed memory.

---

### NOTE

For PSA: After loading all your optional measurement personalities, you should have a reserve of ~2 MBytes memory to facilitate mode switching. Less available memory will increase mode switching time. For example, if you employ excessive free memory by saving files of states and/or data, your mode switching time can increase to more than a minute.

---

You can manually estimate your total memory requirements by adding up the memory allocations described in the following steps. Compare the desired total with the available memory that you identified in the previous section.

1. Program memory - Select option requirements from the table “Measurement Personality Options and Memory Required” on page 45.
2. For PSA only: shared libraries require 7.02 MBytes
3. For PSA only: recommended mode swap space is 2 MBytes
4. Screens - .gif files need 20-25 kB each
5. State memory - State file sizes range from 21 kB for SA mode to 40 kB for W-CDMA. The state of every mode accessed since power-on will be saved in the state file. File sizes can exceed 150 kB each when several modes are accessed, for each state file saved.

---

### TIP

State memory retains settings for all states accessed before the **Save State** command. To reduce this usage to a minimum, reduce the modes accessed before the **Save State** is executed. You can set the PSA to boot into a selected mode by assessing the desired mode, then pressing the **System, Power On/Presets, Power On** keys and toggle the setting to **Last**.

---

## Measurement Personality Options and Memory Required

Personality Options for PSA Series Spectrum Analyzers <sup>a</sup>	Option	File Size (PSA Rev: A.08)
cdmaOne measurement personality	<b>BAC</b>	1.91 Mbytes
NADC and PDC measurement personalities (not available separately)	<b>BAE</b>	2.43 Mbytes
W-CDMA or W-CDMA w/ HSDPA measurement personality	<b>BAF, 210</b>	5.11 Mbytes <sup>b</sup>
cdma2000 or cdma2000 w/ 1xEV-DV measurement personality	<b>B78, 214</b>	4.00 Mbytes <sup>b</sup>
1xEV-DO measurement personality	<b>204</b>	5.11 Mbytes <sup>b</sup>
GSM (with EDGE) measurement personality	<b>202</b>	3.56 Mbytes <sup>b</sup>
Shared measurement library <sup>b</sup>	n/a	7.02 Mbytes
Phase Noise measurement personality	<b>226</b>	2.82 Mbytes <sup>c</sup>
Noise Figure measurement personality	<b>219</b>	4.68 Mbytes <sup>c</sup>
Basic measurement personality with digital demod hardware	<b>B7J</b>	Cannot be deleted (2.34 Mbytes)
HP8566B/HP8568B Programming Code Compatibility <sup>d</sup>	<b>266</b>	1.12 Mbytes <sup>c</sup>
TD-SCDMA	<b>211</b>	5.30 Mbytes <sup>c</sup>
Flexible Digital Modulation Analysis	<b>241</b>	2.05 Mbytes <sup>b</sup>
WLAN measurement personality	<b>217</b>	3.18 Mbytes <sup>b</sup>
External Source Control	<b>215</b>	0.72 Mbytes <sup>c</sup>

- a. Available as of the print date of this guide.
- b. Many PSA Series personality options use a 7.02 Mbyte shared measurement library. If you are loading multiple personalities that use this library, you only need to add this memory allocation once.
- c. Shared measurement library allocation not required.
- d. This is a no charge option that does not require a license key.

<b>Personality Options for E4406A Transmitter Tester <sup>a</sup></b>	<b>Option</b>	<b>File Size (E4406A Rev: A.09)</b>
cdmaOne measurement personality	<b>BAC</b>	1.82 Mbytes
NADC measurement personality	<b>BAE</b>	1.10 Mbytes
PDC measurement personality	<b>BAE</b>	1.23 Mbytes
W-CDMA or W-CDMA w/ HSDPA measurement personality	<b>BAF, 210</b>	5.00 Mbytes
cdma2000 or cdma2000 w/ 1xEV-DV measurement personality	<b>B78, 214</b>	3.88 Mbytes
1xEV-DO measurement personality	<b>204</b>	4.84 Mbytes
GSM (with EDGE) measurement personality	<b>202</b>	3.56 Mbytes
GSM measurement personality	<b>BAH</b>	2.51 Mbytes
EDGE upgrade from BAH measurement personality	<b>252 (202)</b>	3.56 Mbytes
iDEN measurement personality	<b>HN1</b>	2.10 Mbytes
WiDEN measurement personality	<b>HN1</b>	1.58 Mbytes
Baseband I/Q Inputs	<b>B7C</b>	n/a (hardware only)

a. Available as of the print date of this guide.

### Memory Upgrade Kits

The PSA 64 MByte Memory Upgrade kit part number is E4440AU-ANE.

The VSA 64 MByte Memory Upgrade kit part number is E4406AU-ANE.

For more information about memory upgrade kits contact your local sales/service office, or see:

[http://www.agilent.com/find/sa\\_upgrades](http://www.agilent.com/find/sa_upgrades)

### Loading an Optional Measurement Personality

You must use a PC to load the desired personality option into the instrument memory. Loading can be done from a firmware CD-ROM or by downloading the update program from the internet. An automatic loading program comes with the files and runs from your PC.

You can check the Agilent internet website for the latest firmware versions available for downloading:

For PSA, see [http://www.agilent.com/find/psa\\_firmware](http://www.agilent.com/find/psa_firmware)

For E4406A, see [http://www.agilent.com/find/e4406a\\_firmware](http://www.agilent.com/find/e4406a_firmware)

---

**NOTE** When you add a new option, or update an existing option, you will get the updated versions of all your current options as they are all reloaded simultaneously. This process may also require you to update the instrument core firmware so that it is compatible with the new option.

---

Depending on your installed hardware memory, you may not be able to fit all of the available measurement personalities in instrument memory at the same time. You may need to delete an existing option file from memory and load the one you want. Use the automatic update program that is provided with the files. Refer to the table showing [“Measurement Personality Options and Memory Required” on page 45.](#)

The approximate memory requirements for the options are listed above. These numbers are worst case examples. Some options share components and libraries, therefore the total memory usage of multiple options may not be exactly equal to the combined total.

### Obtaining and Installing a License Key

If you purchase an optional personality that requires installation, you will receive an “Entitlement Certificate” which may be redeemed for a license key specific to one instrument. Follow the instructions that accompany the certificate to obtain your license key.

To install a license key number for the selected personality option, use the following procedure:

---

**NOTE** You can also use this procedure to reinstall a license key number that has been deleted during an uninstall process, or lost due to a memory failure.

---

For PSA:

1. Press **System, More, More, Licensing, Option** to access the alpha editor. Use this alpha editor to enter letters (upper-case), and the front-panel numeric keys to enter numbers for the option designation. You will validate your option entry in the active function area of the display. Then, press the **Enter** key.
2. Press **License Key** to enter the letters and digits of your license key. You will validate your license key entry in the active function area of the display. Then, press the **Enter** key.
3. Press the **Activate License** key.

For E4406A:

1. Press **System, More, More, Install, Choose Option** to access the alpha editor. Use this alpha editor to enter letters (upper-case), and the front-panel numeric keys to enter numbers for the option designation. You will validate your option entry in the active



function area of the display. Then, press the **Done** key.

---

**NOTE**

---

Before you enter the license key for the EDGE Retrofit Option 252, you must already have entered the license key for the GSM Option BAH.

2. Press **License Key** to enter the letters and digits of your license key. You will validate your license key entry in the active function area of the display. Then, press the **Done** key.
3. Press the **Install Now** key. The message “New option keys become active after reboot.” will appear, along with the **Yes/No** menu: press the **Yes** key and cycle the instrument power off and then on to complete your installation process, or press the **No** key to cancel the installation process.

### Viewing a License Key

Measurement personalities purchased with your instrument have been installed and activated at the factory before shipment. The instrument requires a **License Key** unique to every measurement personality purchased. The license key number is a hexadecimal number specific to your measurement personality, instrument serial number and host ID. It enables you to install, or reactivate that particular personality.

Use the following procedure to display the license key number unique to your personality option that is already installed in your instrument:

For PSA:

Press **System, More, More, Licensing, Show License**. The **System, Personality** key displays the personalities loaded, version information, and whether the personality is licensed.

For E4406A:

Press **System, More, More, Install, Choose Option** to enter the letters/numbers for the option you want. You can see the key on the **License Key** softkey. Press the **Done** key.

---

**NOTE**

---

*You will want to keep a copy of your license key number in a secure location. Press **System, More, then Licensing, Show License** for PSA, or **Show System** for E4406A, and print out a copy of the display that shows the license numbers. If you should lose your license key number, call your nearest Agilent Technologies service or sales office for assistance.*

---

### Using the Delete License Key on PSA

This key will make the option unavailable for use, but will not delete it from memory. Write down the 12-digit license key number for the option before you delete it. If you want to use that measurement personality later, you will need the license key number to reactivate the

personality firmware.

---

**NOTE**

Using the **Delete License** key does not remove the personality from the instrument memory, and does not free memory to be available to install another option. If you need to free memory to install another option, refer to the instructions for loading firmware updates located at the URL: <http://www.agilent.com/find/psa/>

---

1. Press **System, More, More, Licensing, Option**. Pressing the **Option** key will activate the alpha editor menu. Use the alpha editor to enter the letters (upper-case) and the front-panel numeric keyboard to enter the digits (if required) for the option, then press the **Enter** key. As you enter the option, you will see your entry in the active function area of the display.
2. Press **Delete License** to remove the license key from memory.

### Using the Uninstall Key on E4406A

This key will make the option unavailable for use, but will not delete it from memory. The message “Application Not Licensed” will appear in the Status/Info bar at the bottom of the display. Record the 12-digit license key number for the option before you delete it. If you want to use that measurement personality later, you will need the license key number to reactivate the personality firmware.

---

**NOTE**

Using the **Uninstall** key does not remove the personality firmware from the instrument memory, and does not free memory to be available to install another option. If you need to free memory to install another option, refer to the instructions for loading firmware updates available at the URL: <http://www.agilent.com/find/vsa/>

---

1. Press **System, More(1 of 3), More(2 of 3), Uninstall, Choose Option** to access the alpha editor. Use this alpha editor to enter the letters (upper-case), and the front-panel numeric keys to enter the numbers (if required) for the installed option. You will validate your option entry in the active function area of the display. Then, press the **Done** key.
2. Pressing the **Uninstall Now** key will activate the **Yes/No** menu: press the **Yes** key to continue your uninstall process, or press the **No** key to cancel the uninstall process.
3. Cycle the instrument power off and then on to complete the uninstall process.

### Performing a Security Erase on PSA Series Spectrum Analyzers

A Security Erase of a PSA can erase all memory including the operating system.

To perform a security erase of your instrument memory, you will need to download “WipeSA” from the Agilent Web site. For more information see:

[http://www.agilent.com/find/sa\\_security](http://www.agilent.com/find/sa_security)

Instructions for security erase procedures are available for downloading.

---

**CAUTION**

---

Security Erase procedures can leave your instrument in an inoperative state. Be sure to follow the instructions carefully.

## Ordering Optional Measurement Personalities

When you order a personality option, you will receive an entitlement certificate. Then you will need to go to the web site to redeem your entitlement certificate for a license key. You will need to provide your instrument serial number and host ID, and the entitlement certificate number.

<b>Required Information:</b>	<b>Front Panel Key Path:</b>
Model #: (Ex. E4440A)	
Host ID: _____	System, Show System
Instrument Serial Number: _____	System, Show System

---

## **2 Making Measurements**

This chapter describes procedures used for making measurements of 1xEV-DO BTS or MS. Instructions to help you set up and perform the measurements are provided, and examples of 1xEV-DO measurement results are shown.

---

## 1xEV-DO Measurements

This chapter begins with instructions common to all measurements made by the Transmitter Tester, then details all 1xEV-DO measurements available by pressing the **MEASURE** key. For information specific to individual measurements refer to the sections at the page numbers below.

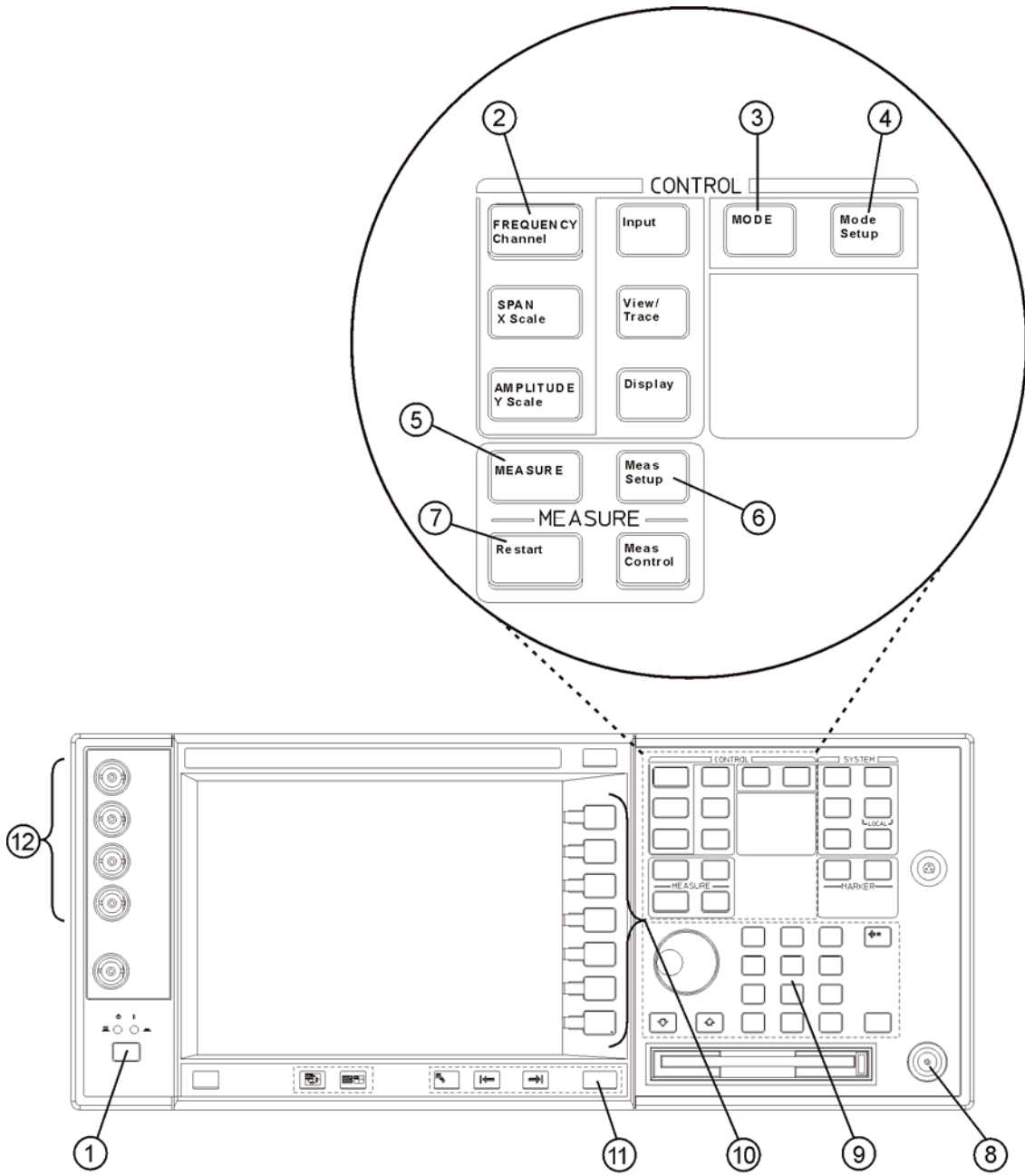
- “Channel Power Measurements” on page 60
- “Forward Link Code Domain Measurements” on page 63
- “Reverse Link Code Domain Measurements” on page 72
- “Intermodulation Measurements” on page 85
- “Forward Link Modulation Accuracy (Composite Rho) Measurements” on page 89
- “Reverse Link Modulation Accuracy (Composite Rho) Measurements” on page 96
- “Occupied Bandwidth Measurements” on page 103
- “Power Statistics CCDF Measurements” on page 106
- “Power versus Time Measurements” on page 109
- “QPSK EVM Measurements” on page 113
- “Spectrum (Frequency Domain) Measurements” on page 118
- “Spurious Emissions & ACP Measurements” on page 128
- “Waveform (Time Domain) Measurements” on page 133
- “Using Basic Mode” on page 141
- “Understanding Common Measurement Errors” on page 142

All the measurements above are referred to as one-button measurements. When you press the key to select a measurement it will become active, using settings and displays unique to that measurement. Data acquisition will automatically begin when trigger requirements, if any, are met.

## Instrument Front Panel Highlights

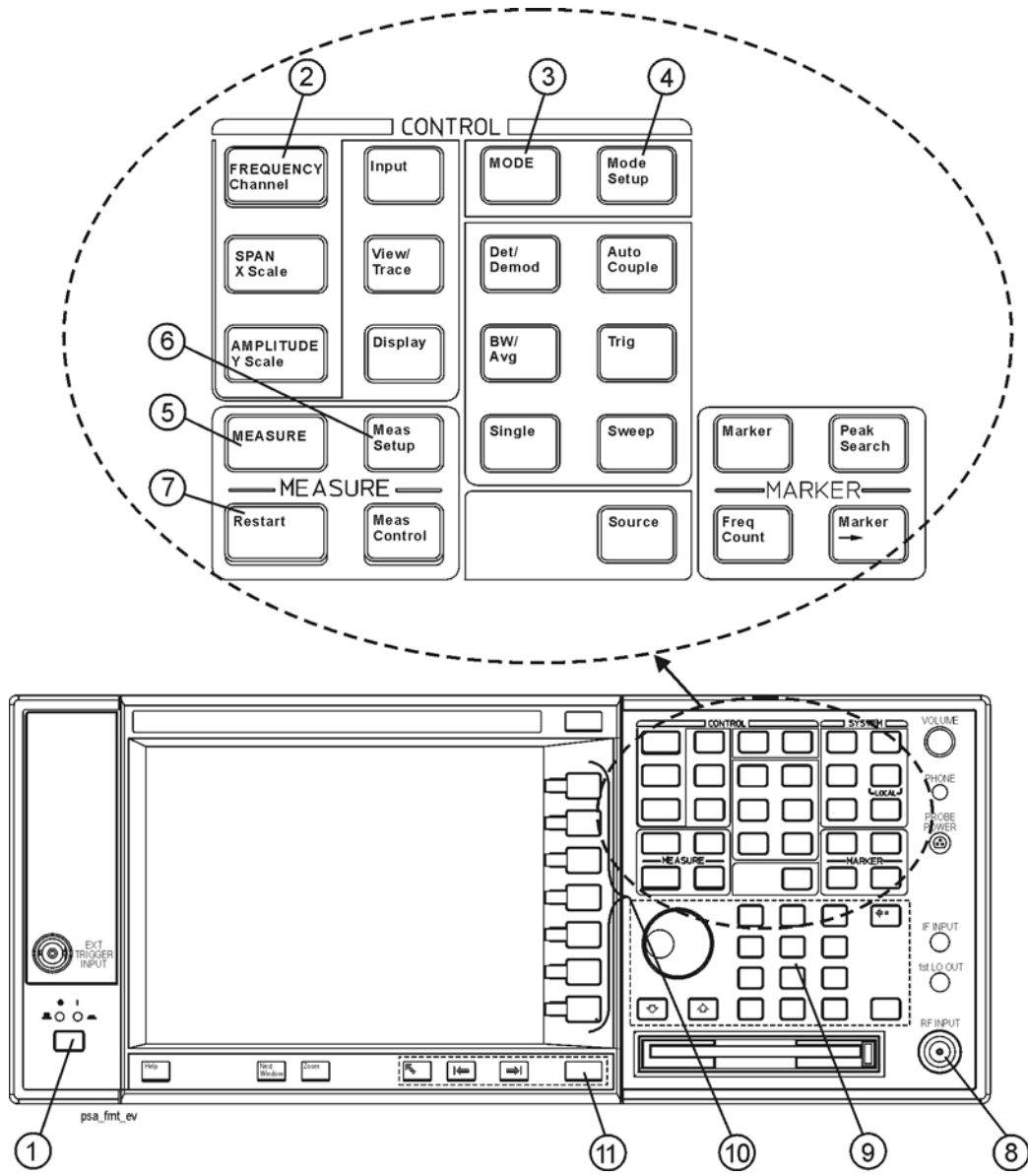
The most commonly used function keys on the VSA and PSA front panels are located as shown in the illustrations below. The operation of the keys is briefly explained on the following page. Refer to your User's Guide for complete details on all keys.

**Figure 2-1 E4406A Selected Front Panel Key Locations**



aa81a

Figure 2-2 PSA Selected Front Panel Key Locations





1. The **On/Off** switch toggles the AC Line power on or off. A green LED will light when the instrument is On. When energized in the standby mode, a yellow LED is lit above the **On/Off** switch.
2. **FREQUENCY Channel** accesses a display key menu that to set the analyzer center frequency in units of Hz, kHz, MHz, or GHz, or by channel number. These parameters apply to all measurements in the current mode.
3. **MODE** accesses a key menu to select one of the measurement personalities installed in the instrument. Each mode is independent from all other modes.
4. **Mode Setup** accesses a key menu that sets parameters specific to the current mode and affect all measurements within that mode.
5. **MEASURE** accesses a display key menu to initiate one of the various measurements that are specific to the current mode.
6. **Meas Setup** accesses the menus of test parameters that are specific to the current measurement.
7. **Restart** causes a measurement to start again from the initial process according to the current measurement setup parameters.
8. The **RF INPUT** port “N” connector allows you to apply an external RF signal. The maximum input power level is shown next to the port.
9. The **Data Entry** keypad is used to enter numeric values to parameters. A value from this keypad will be displayed in the active function area of the screen, then the value will become valid for the current measurement upon pressing the **Enter** key or selecting a unit of measurement depending on the parameter.
10. The Display Menu keys allow you either to activate a feature or to access a more detailed sub-menu. An arrow on the right side of a softkey label indicates that the key has a further selection menu. The active menu key is highlighted, however, grayed-out keys are currently unavailable for use or are only to show information. If a menu has multiple pages, successive pages are accessed by pressing the **More** key located at the bottom of the menu.
11. Pressing the **Return** key allows you to exit from the current menu and display the previous menu. Often, pressing a menu key will invoke a multi-page sub-menu. Pressing the **Return** key will show the menu “above” it, not a previous page . When you activate another measurement, the return list is cleared. The **Return** key will not return you to a previously activated mode, nor will it alter any values you have entered in previous menus.
12. Baseband I/Q Inputs (E4406A Option B7C) allow you to analyze signals at baseband frequencies. See [“Using Option B7C Baseband I/Q Inputs” on page 1.](#)

## Setting up and Making a Measurement

### Making the Initial Signal Connection

---

**CAUTION**

Before connecting a signal to the instrument, make sure the instrument can safely accept the signal level provided. The signal level limits are marked next to the connectors on the front panel.

See “[Input Key Menu](#)” on page 119 for details on selecting input ports and setting internal attenuation to prevent overloading the instrument.

See “[Input Key Menu](#)” on page 119 for details of **Int Preamp** and **Attenuator** operation.

### Using Instrument Mode and Measurement Presets

If you want to set your current measurement personality to a known, factory default state, press **Preset**. This initializes the instrument by returning the mode setup and all of the measurement setups in the mode to the factory default parameters.

---

**NOTE**

For PSA, note that pressing the **Preset** key will switch instrument modes unless the type of preset is selected under **System, Power On/Preset** is set to **Mode** or **Save User Preset**.

To preset only the parameters that are specific to an active, selected measurement, press **Meas Setup**, then **Restore Meas Defaults**. **Restore Meas Defaults** will return all the measurement setup parameters to the factory defaults, but only for the currently selected measurement. The **Restore Meas Defaults** key may not appear on the first page of the **Meas Setup** menu. If not, press **More** until the key is available.

## The 3 Steps to Set Up and Make Measurements

All measurements need to be set up in 3 steps: first at the Mode level, second at the Measurement level, then finally the result display may be adjusted.

### 1. Select and Set Up the Mode

Press **MODE** - All licensed, installed Modes available are shown. Press **1xEV-DO**, or select **Basic** mode to make measurements of signals with non-standard formats.

Press **Mode Setup** - Make any required adjustments to the mode settings. These settings apply to all measurements in the mode.

### 2. Select and Set Up the Measurement

Press **MEASURE** - Select a specific measurement to be performed (e.g. **ACP**, **Channel Power**, or **EVM**). The measurement begins as soon as any required trigger conditions are met. The resulting data is shown on the display or is available for export.

Press **Meas Setup** - Make any adjustments as required to the selected measurement settings. The settings only apply to this measurement.

### 3. Select and Set Up a View of the Results

Press **Trace/View** - Select a display format for the current measurement data. Depending on the mode and measurement selected, other graphical and tabular data presentations may be available. **X-Scale** and **Y-Scale** adjustments may also be made now.

---

**NOTE** A setting may be reset at any time, and will be in effect on the next measurement cycle or View.

---

Step	Primary Key	Setup Keys	Related Keys
1. Select & set up a Mode	<b>MODE</b>	<b>Mode Setup, Input (E4406A), Input/Output (PSA), FREQUENCY Channel</b>	<b>System</b>
2. Select & set up a Measurement	<b>MEASURE</b>	<b>Meas Setup</b>	<b>Meas Control, Restart</b>
3. Select & set up a View of the Results	<b>View/Trace (E4406A), Trace/View (PSA)</b>	<b>SPAN X Scale, AMPLITUDE Y Scale, Display, Next Window, Zoom</b>	<b>File, Save, Print, Print Setup, Marker, Search (E4406A), Peak Search (PSA)</b>

## Channel Power Measurements

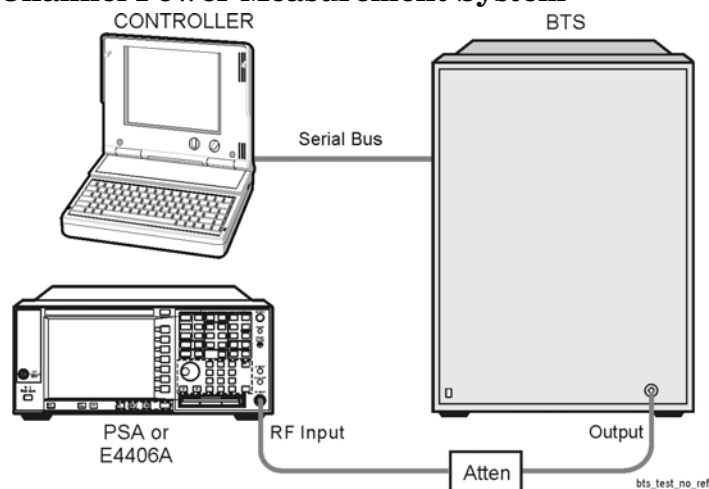
This section explains how to make a channel power measurement on a 1xEV-DO base station. This test measures the total RF power present in the channel. The results are displayed graphically as well as in total power (dB) and power spectral density (dBm/Hz).

### Configuring the Measurement System

The access network (BTS) under test has to be set to transmit the RF power remotely through the system controller. This transmitting signal is connected to the instrument's RF input port. Connect the equipment as shown below:

Figure 2-3

### Channel Power Measurement System



1. Using the appropriate cables, adapters, and attenuators, connect the output signal from the BTS to the RF input port of the instrument.
2. Connect the system controller to the BTS through the serial bus cable to control the BTS operation.

### Setting Up the BTS

From the system controller, perform all of the functions required for the BTS to transmit the RF signal.

- BTS
  - Frequency: 1,935.000 MHz (preferred channel number 100)  
(1,935.000 = (100 × 0.050) + 1930.000 MHz)
  - Output Power: Specified maximum output power level

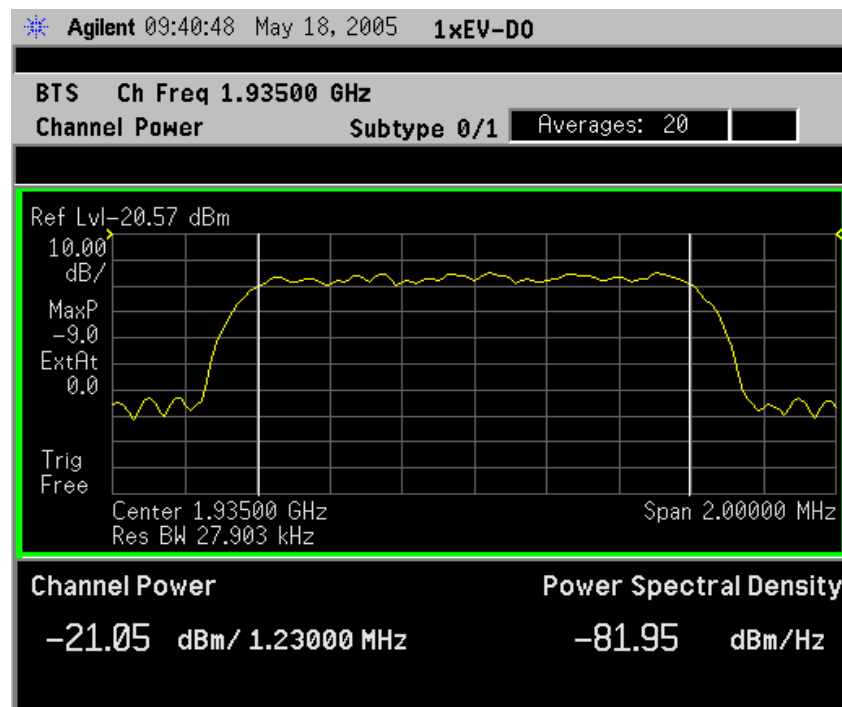
## Measurement Procedure

- Step 1.** Press the **System, Reference, Freq Ref** keys to toggle the frequency reference to EXT, if required. In the annunciator bar you will see EXT REF displayed in green.
- Step 2.** Press the **MODE, 1xEV-DO, Preset** keys to enable and preset the 1xEV-DO measurements.
- Step 3.** If your UUT is a MS, Press the **Mode Setup, Radio, Device** keys to toggle the selection to MS.
- Step 4.** Press the **Mode Setup, Input, Max Total Pwr** to enter the estimated maximum power from the BTS.
- Step 5.** Press the **Input Atten** and/or **Ext RF Atten** to enter the appropriate attenuation values depending on the estimated maximum power from the BTS.
- Step 6.** Press the **FREQUENCY Channel, 1935, MHz** keys to set the center frequency to 1,935.000 MHz.
- Step 7.** Press the **MEASURE, Channel Power** keys to initiate the channel power measurement.

The Channel Power measurement result should look like the next figure.

Figure 2-4

### Channel Power Measurement Result



**Step 8.** Press the **Meas Setup, More (1 of 2)** keys to check the keys available to change the measurement parameters from the default condition.

If you get an error message, see [“Understanding Common Measurement Errors”](#) on page 142.

## Forward Link Code Domain Measurements

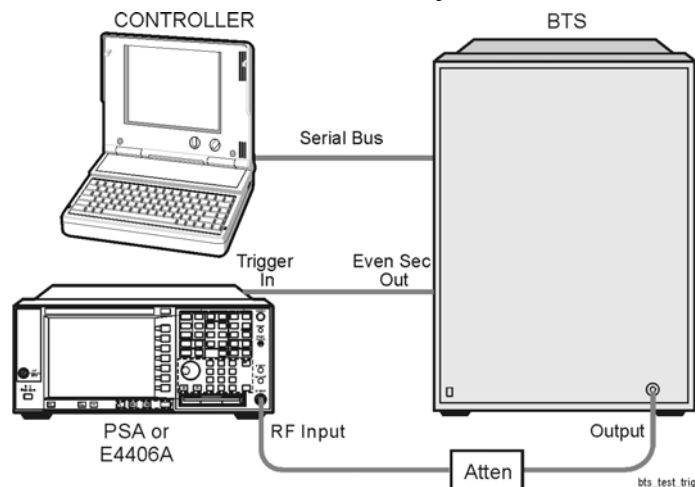
This section explains how to make a code domain measurement on a 1xEV-DO base station. This is the measurement of the power levels of the spread channels in composite RF channels, relative to the total power within the 1.230 MHz channel bandwidth centered at the center frequency.

### Configuring the Measurement System

The access network (BTS) under test has to be set to transmit the RF power remotely through the system controller. This transmitting signal is connected to the instrument's RF input port. Connect the equipment as shown below:

Figure 2-5

### Code Domain Power Measurement System



1. Using the appropriate cables and attenuators, connect the output signal from the BTS to the RF input port of the instrument.
2. Connect the system controller to the BTS through the serial bus cable to control the BTS operation.
3. Connect an appropriate cable assembly between the TRIGGER IN connector of the instrument and the Even Sec Out connector of the BTS for synchronization.

## Setting the BTS

From the system controller, perform all of the functions required for the BTS to transmit the RF signal.

- **BTS**
  - Frequency: 1,935.000 MHz (preferred channel number 100)  
((1,935.000 = (100 × 0.050) + 1930.000 MHz)
  - Output Power: Specified maximum output power level

## Measurement Procedure

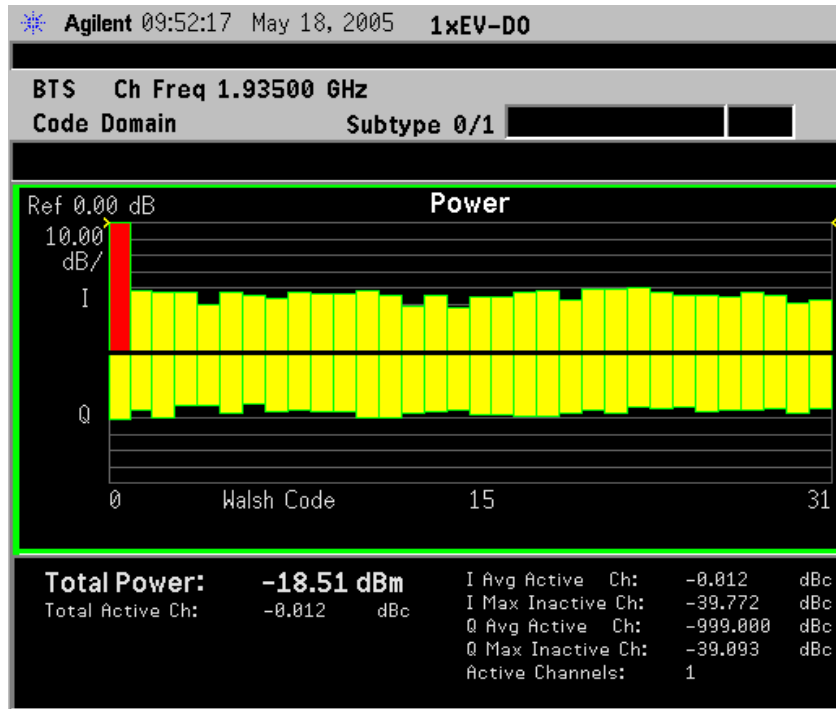
- Step 1.** Press the **Preset** key to preset the instrument.
- Step 2.** Press the **MODE, More (1 of 2), 1xEV-DO** keys to enable the 1xEV-DO measurements.
- Step 3.** Press the **Mode Setup, Input, Max Total Pwr** to enter the estimated maximum power from the BTS.
- Step 4.** Press the **Mode Setup, Demod** keys and toggle the **Physical Layer Subtype** selection to select either **0/1** or **2**.
- Step 5.** Press the **Input Atten** and/or **Ext RF Atten** to enter the appropriate attenuation values depending on the estimated maximum power from the BTS.
- Step 6.** Press the **FREQUENCY Channel, 1935, MHz** keys to set the center frequency to 1,935.000 MHz.
- Step 7.** Press the **MEASURE, More (1 of 2), Code Domain** keys to initiate the Forward Link Code Domain measurement.
- Step 8.** If your 1xEV-DO active channel signal is known, you may be able to take advantage of a predefined Active Channel preset for synchronization. Press **Meas Setup, More, Active Code Channel** and then press **Predefined**. Then press **Predefined Active Channel** and select from the list of predefined Active Channels shown.
- Step 9.** Press the **Meas Setup, More, 1 Long Code Mask** and enter the Hexadecimal long code for I.



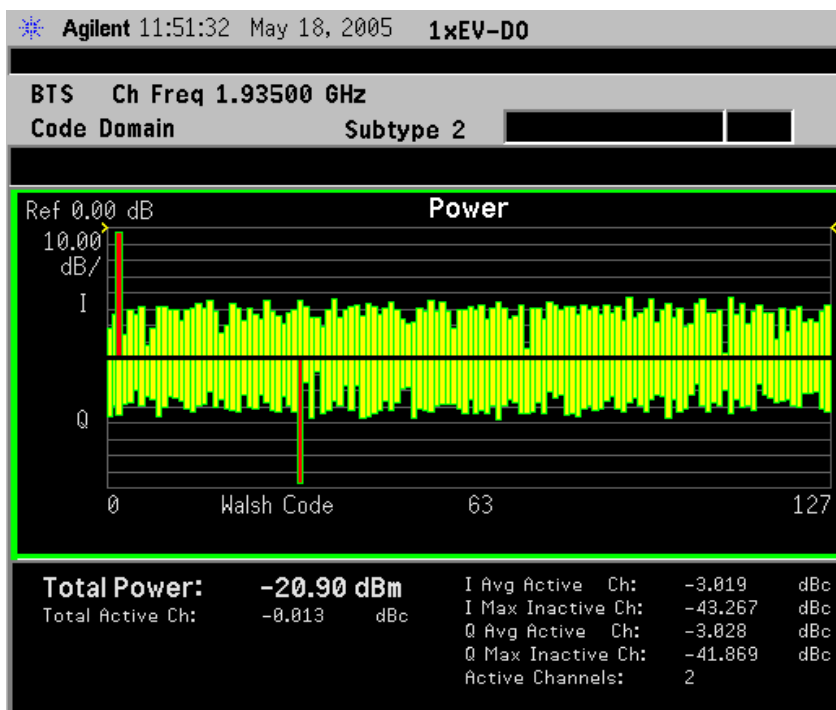
**Step 10.** Press the **Meas Setup, More, Q Long Code Mask** and enter the Hexadecimal long code for Q.

The Code Domain: Power measurement result should look like the next figure. The graph window and the text window are displayed for the pilot channel. The text window shows the total power level along with the relative power levels of the various channels.

**Figure 2-6** Forward Link Code Domain Measurement Result - Power Graph (Default) View- Subtype 0/1

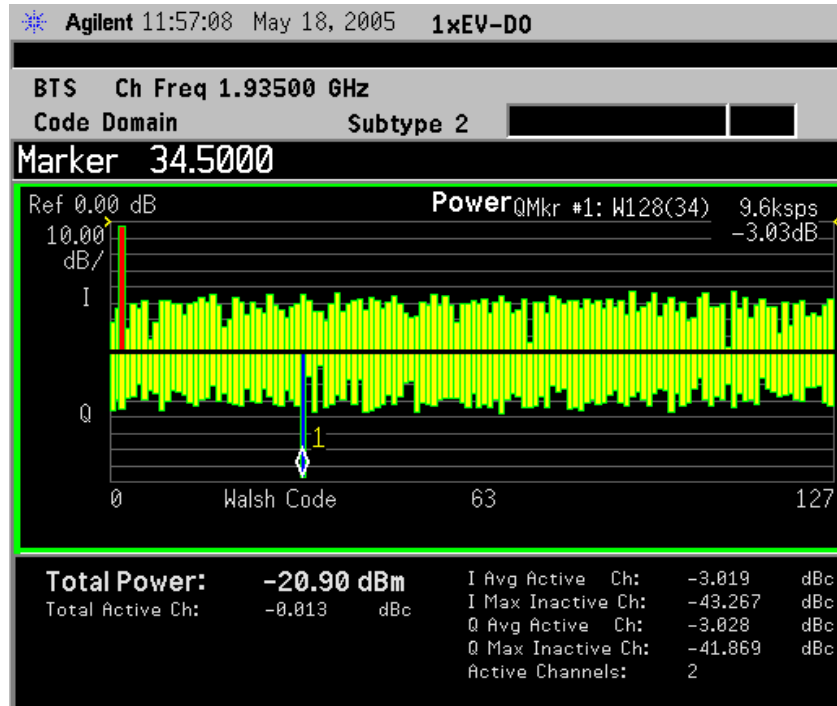


**Figure 2-7** Forward Link Code Domain Measurement Result - Power Graph (Default) View - Subtype 2



**NOTE** The Walsh Code index for Subtype 2 signals is 127, as shown above.

**Step 11.** To examine a single channel more closely, set a marker on the channel of interest. Press **Marker** and either use the step up arrow or the dial to position the marker. In this example we will select the Data channel marked at W128 (34) as shown below. The marker data indicates a Walsh Code position of 34.5, but that is because it is on the Q Branch.

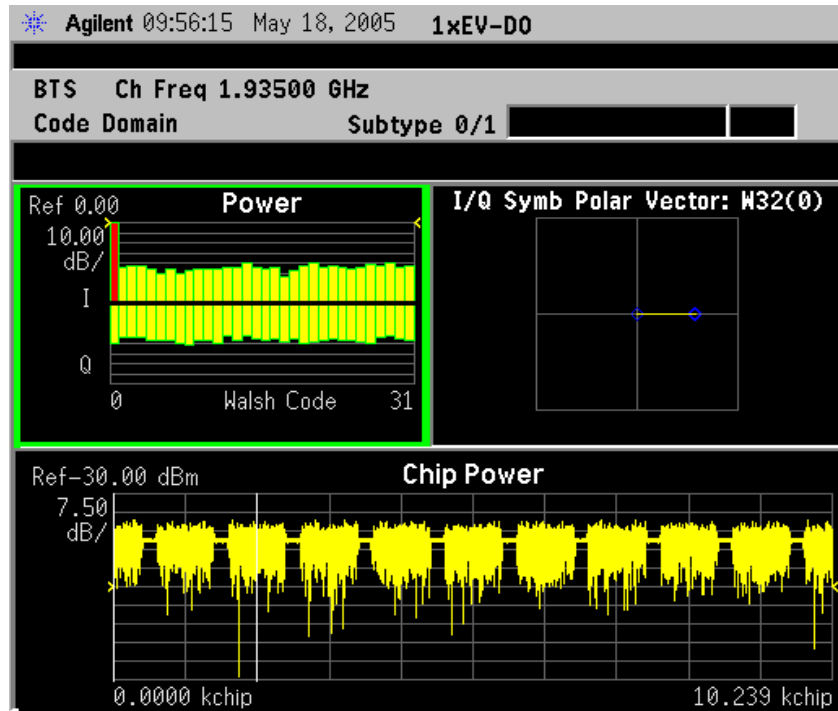


Press **Marker**, **More**, and **Mkr-> Despread**. This will allow you to select this code channel for specific Code Domain Power measurement. The Marker Despread feature automatically determines the Code Domain parameters of the code channel, and sets the instrument to the appropriate settings for Symbols/sec, Walsh Code Number, and Offset. Any code channel selected by a normal #1 marker can be despread. The measurement data shown above reflects the despread measurement data.

To change a display parameter like **AMPLITUDE Y Scale**, **Scale/Div** the window must be made “active”, which is shown on the display as the window with a green outline. Press **Next Window** to activate the other window, and **Zoom** to display only a single window.

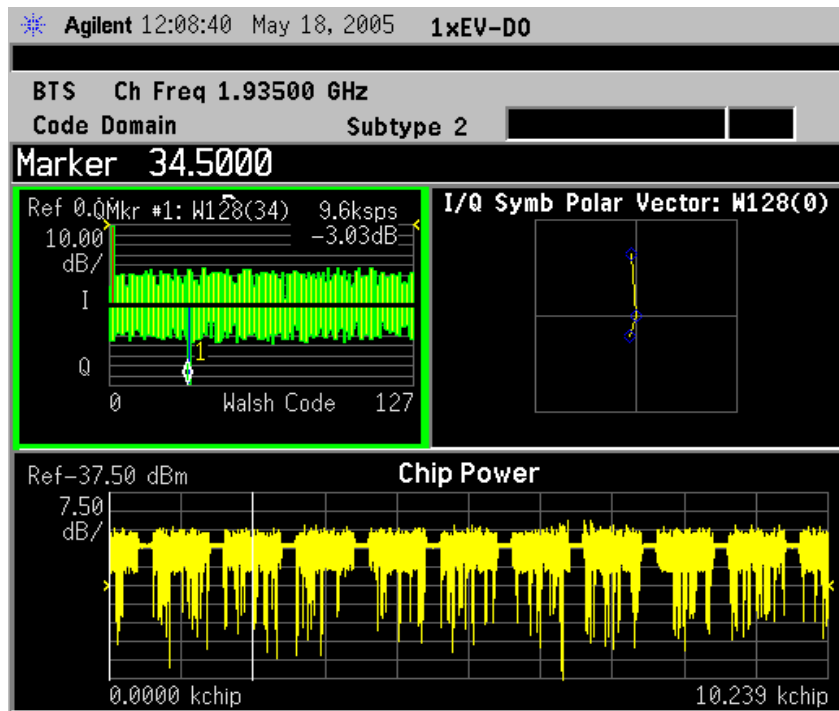
**Step 12.** Press the **View/Trace, I/Q Polar & Power Graph** keys to display a combination view of the code domain power, I/Q symbol polar vector, and selected chip power graph windows for the pilot channel as shown below:

**Figure 2-8 Forward Link Code Domain Measurement Result - I/Q Polar and Power Graph View- Subtype 0/1**



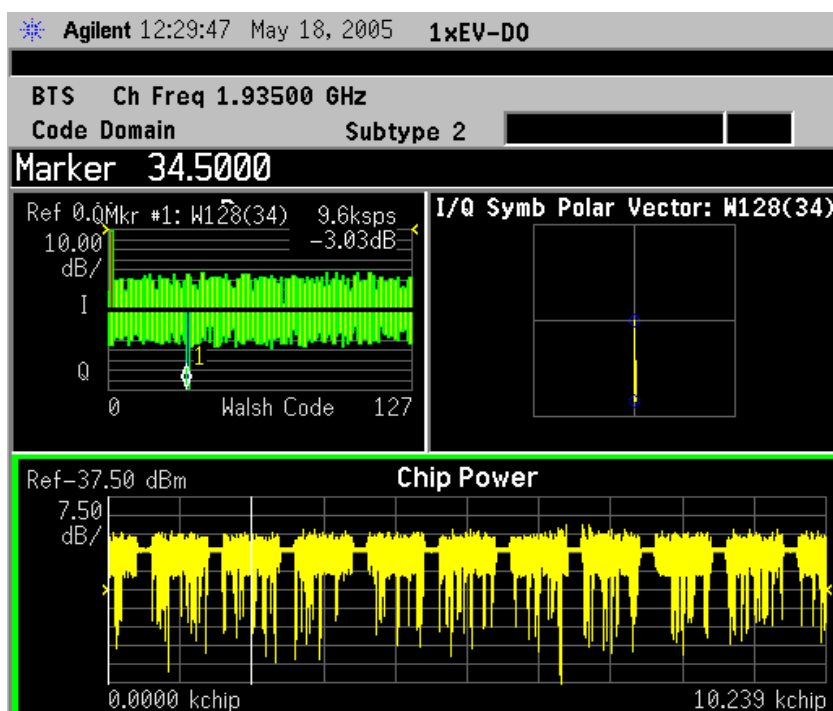
In the Chip Power window, the yellow data are the individual chip power measurements in each slot, across the entire Capture Interval of 10 slots, or equivalent to 10.239 kchips. The 2 vertical lines indicate the Meas Interval of 2 slots.

**Figure 2-9** Forward Link Code Domain Measurement Result - I/Q Polar and Power Graph View - Subtype 2



You can see from the screen image above that the code channel measurement data shown is for W128(0), the Pilot Channel. Since the marker is still at 34.5, if you press **Marker, More, and Mkr-> Despread**, the measurement data will apply to the marked channel, including the constellation window, as shown in the following figure.

**Figure 2-10** Forward Link Code Domain Measurement Result - I/Q Polar and Power Graph View - Subtype 2 with W128(34) Despread



- Step 13.** Press the **Meas Control** key to change the **Measure** key from **Single** to **Cont**. The measurement and displayed data will be made repeatedly.
- Step 14.** Press the **Meas Setup, More (1 of 3), More (2 of 3)** keys to check the keys available to change the measurement parameters from the default condition.

For more information about making Code Domain Power measurements see [“Reverse Link Code Domain Measurements”](#) on page 72.

If you get an error message, see [“Understanding Common Measurement Errors”](#) on page 142.

### Troubleshooting Hints

Uncorrelated interference may cause CW interference like local oscillator feedthrough or spurs. Another uncorrelated noise may be due to I/Q modulation impairments. Correlated impairments can be due to the phase noise on the local oscillator in the upconverter or I/Q modulator of the UUT. These will be analyzed by the code domain measurements along with the QPSK EVM measurements and others.

A poor phase error indicates a problem at the I/Q baseband generator, filters, and/or modulator in the transmitter circuitry of the UUT. The

output amplifier in the transmitter can also create distortion that causes unacceptably high phase error. In a real system, a poor phase error will reduce the ability of a receiver to correctly demodulate the received signal, especially in marginal signal conditions.

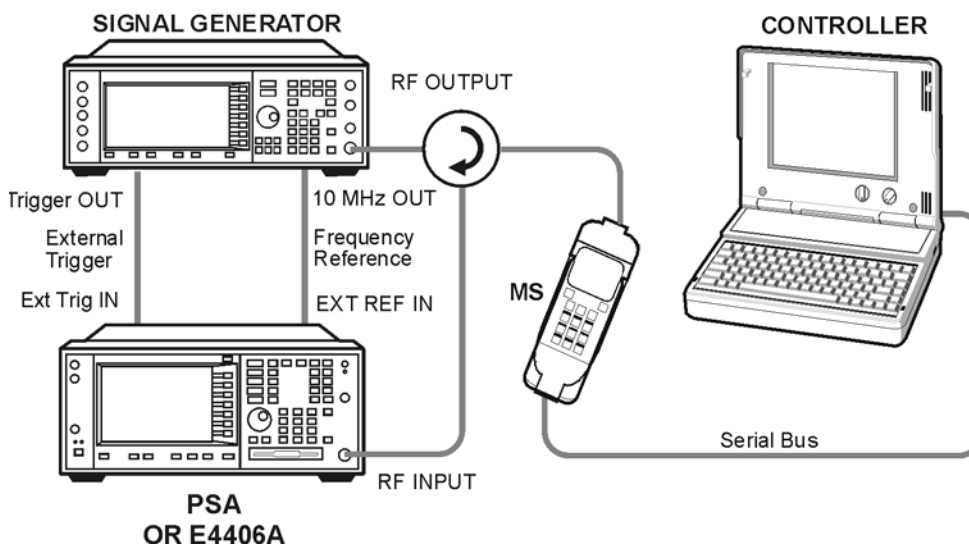
## Reverse Link Code Domain Measurements

This section explains how to make a code domain measurement on a 1xEV-DO mobile station (MS). This is the measurement of the power levels of the spread channels in composite RF channels, relative to the total power within the 1.230 MHz channel bandwidth centered at the center frequency.

### Configuring the Measurement System

For configuring the measurement system, the access terminal (MS) under test has to be set to transmit the RF power remotely through the system controller. This transmitting signal is connected to the instrument's RF input port. Connect the equipment as shown.

**Figure 2-11** Power Control Measurement System



1. Using the appropriate cables, adapters, and circulator, connect the output signal of the MS to the RF input of the instrument.
2. Connect the base transmission station simulator or signal generator to the MS through the circulator to initiate a link constructed with the sync and pilot channels, if required.
3. Connect a BNC cable between the 10 MHz OUT port of the signal generator and the EXT REF IN port of the instrument.
4. Connect a trigger signal from the signal generator or system controller and the EXT TRIG IN port of the instrument.
5. Connect the system controller to the MS through the serial bus cable to control the MS operation.



## Setting the MS

From the system controller, perform all of the functions required for the MS to transmit the RF test signal.

Test Signal      Physical Layer Subtype 0 or 1  
                         1 to 4 Active Channels: Pilot/RRP, DRC, ACK and Data

Frequency        1,935.000 MHz (preferred channel number 100)  
                         (1,935.000 = (100 × 0.050) + 1930.000 MHz)

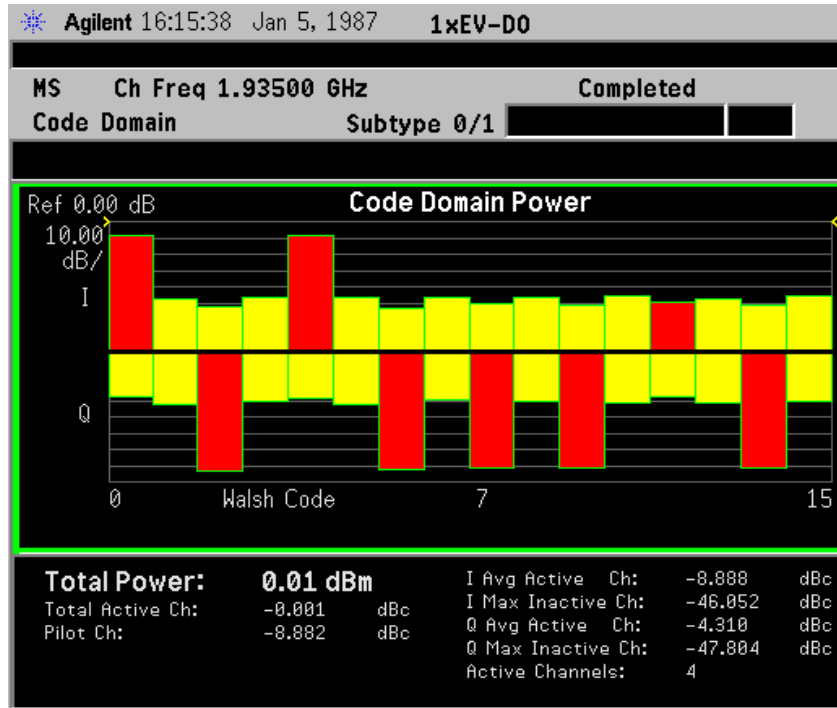
Output Power:   Specified maximum output power level  
                         (Example power output set to 0 dBm)

## Measurement Procedure

- Step 1.** Press the **Preset** key to preset the instrument.
- Step 2.** Press the **MODE, More (1 of 2), 1xEV-DO** keys to enable the 1xEV-DO measurements.
- Step 3.** Press the **Mode Setup, Radio, Device** keys to toggle the selection to **MS**.
- Step 4.** Press the **Mode Setup, Demod** keys and toggle the **Physical Layer Subtype** selection to select either **0/1** or **2**.
- Step 5.** Press the **Mode Setup, Input, Max Total Pwr** keys to enter the estimated maximum power from the MS.
- Step 6.** Press **Mode Setup, Demod**, and select the test signal **Physical Layer Subtype 0/1** or **2**.
- Step 7.** Press the **Input Atten** and/or **Ext RF Atten** to enter the appropriate attenuation values depending on the estimated maximum power from the MS.
- Step 8.** Press the **FREQUENCY Channel, 1935, MHz** keys to set the center frequency to 1,935.000 MHz.
- Step 9.** Press the **MEASURE, More (1 of 2), Code Domain** keys to initiate the Reverse Link Code Domain measurement.
- Step 10.** If your 1xEV-DO active channel signal is known, you may be able to take advantage of a predefined Active Channel preset for synchronization. Press **Meas Setup, More, Active Code Channel** and then press **Predefined**. Then press **Predefined Active Channel** and select from the list of predefined Active Channels shown.
- Step 11.** Press the **Meas Setup, More, I Long Code Mask** and enter the Hexadecimal long code for I.
- Step 12.** Press the **Meas Setup, More, Q Long Code Mask** and enter the Hexadecimal long code for Q.

The Code Domain Power Graph measurement result should look like the next figure. The measurement values for Reverse Link Code Domain measurement are shown in the summary result window.

**Figure 2-12 Reverse Code Domain Measurement Result - Code Domain Power Graph (Default) View**

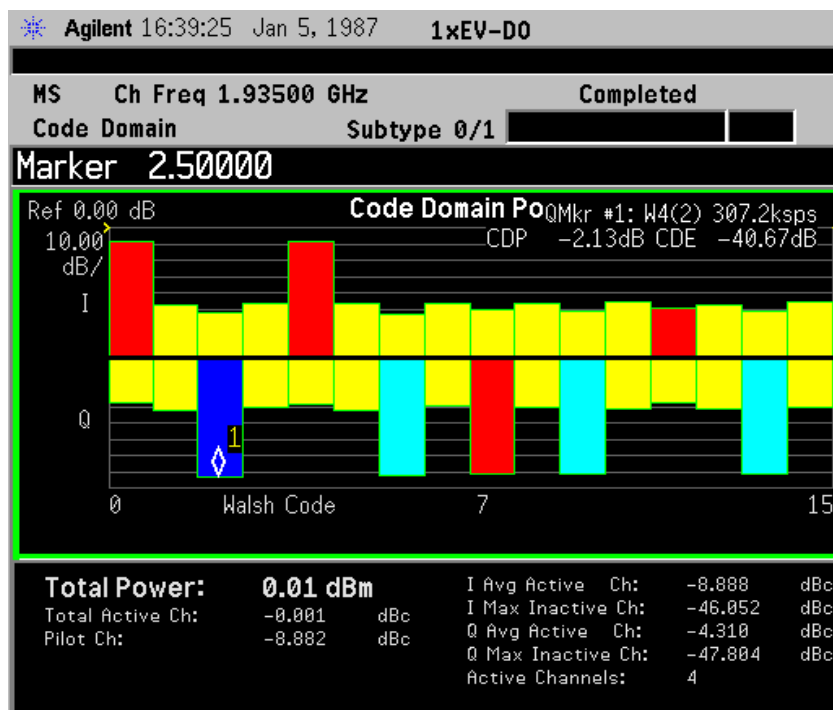


**Step 13.** Press **Marker** and rotate the RPG dial to position the marker. The example below shows the marker at the Q channel at W4(2). The marker channel is shown in dark blue, while other Walsh Code channels that are associated with W4(2) are shown in light blue. The marker data indicates Code Domain Power (CDP) and Code Domain Error (CDE) for the channel marked. Individual channel measurement results are also available in other CDP displays described later.

Press **Off** in the **Marker** menu to remove the marker.

**Figure 2-13**

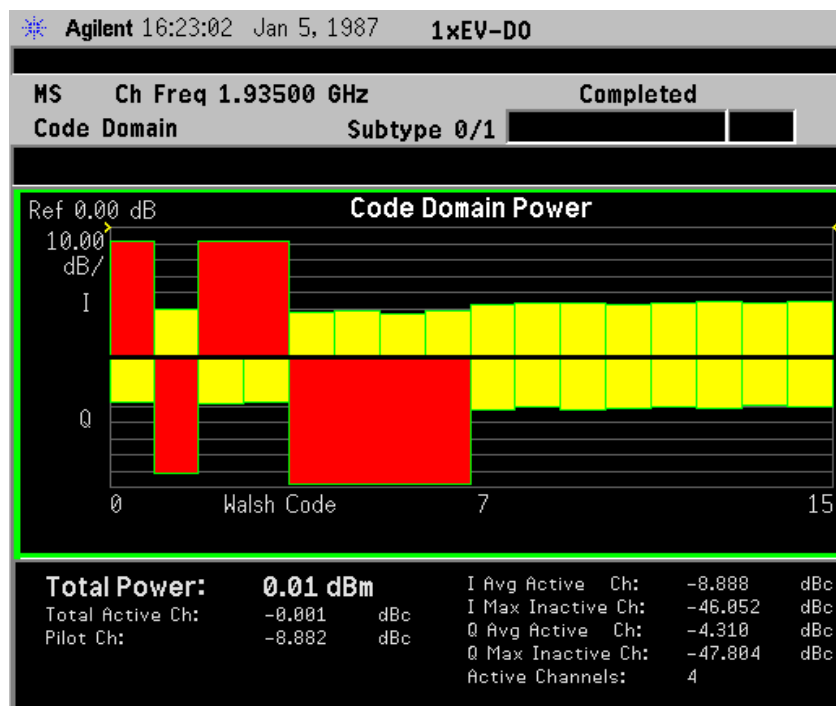
**Reverse Code Domain Measurement Result - Code Domain Power Graph View with Marker**



**Step 14.** Press **Display**, **Code Order**, and toggle the setting from **Hadamard** to **Bit Reverse**.

As shown below, using the Bit Reverse display combines the similar function channels seen in the previous display into blocks of adjacent channels. The Walsh Code number scale across the x axis no longer applies to the individual channel codes, but still accurately shows the quantity of active channels applied to the I and Q codes.

**Figure 2-14** Reverse Code Domain Measurement Result - Code Domain Power Graph View with Bit Reverse Display

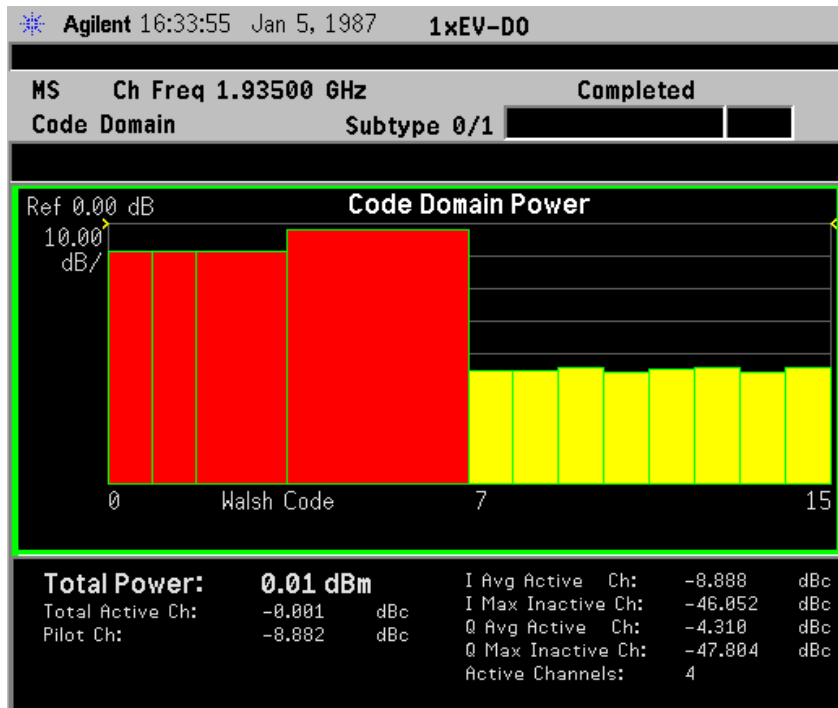


**Step 15.** Press **Display, I/Q Combined Power Bar**, and toggle the setting from **Off** to **On**.

As shown below, using the Combined Power Bar display combines the I and Q code channels into blocks of adjacent channels on a single code axis. As you can see now, there are only 3 channel types in this example. The Walsh Code number scale across the x axis no longer applies to the individual channel codes, but still accurately shows the quantity of active channels applied to the I and Q codes.

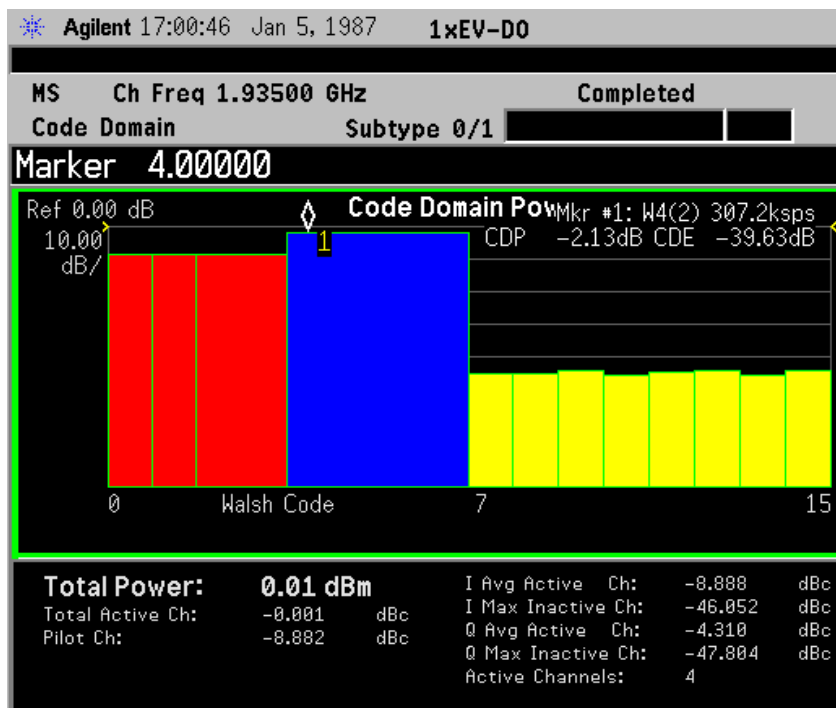
**Figure 2-15**

**Reverse Code Domain Measurement Result - Code Domain Power Graph View with Bit Reverse Display (I/Q Combined)**



**Step 16.** Press **Peak Search**. The Peak marker will mark the most powerful code channel and display the Walsh Code number, the CDP and CDE.

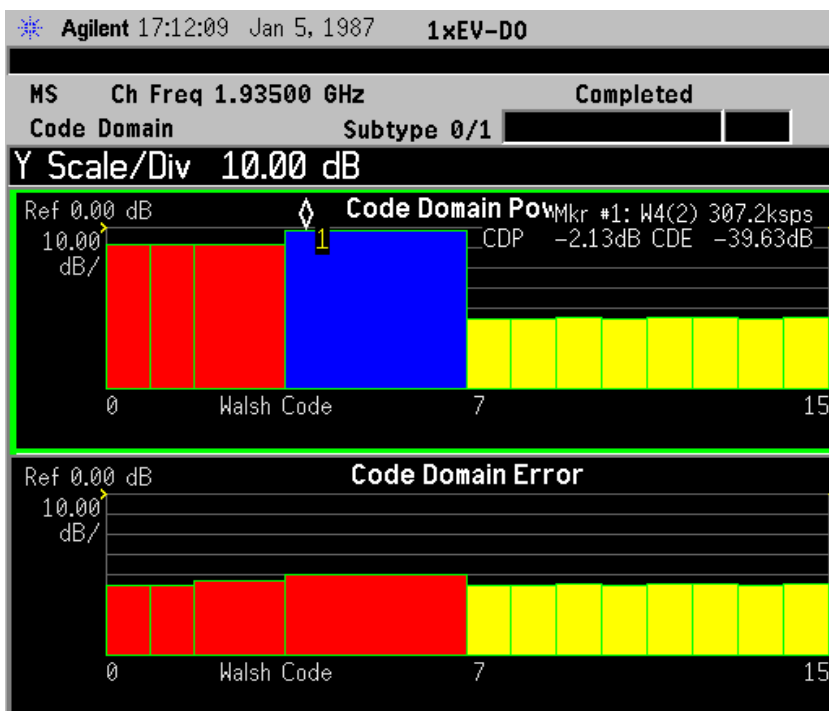
**Figure 2-16** Reverse Code Domain Measurement Result - Code Domain Power Graph View with Bit Reverse Display (I/Q Combined)



**Step 17.** Press the **View/Trace, CDP & CDE Graph** keys to display a two-pane view of the code domain power and code domain error for the code channels as set up in previous steps. You can select the Hadamard view or turn off the Combined Power Bar in any of the following views.

To change a display parameter like **AMPLITUDE Y Scale, Scale/Div** the window must be made “active”, which is shown on the display as the window with a green outline. Press **Next Window** to activate the other window, and **Zoom** to display only a single window.

**Figure 2-17** Reverse Link Code Domain Measurement - CDP & CDE View

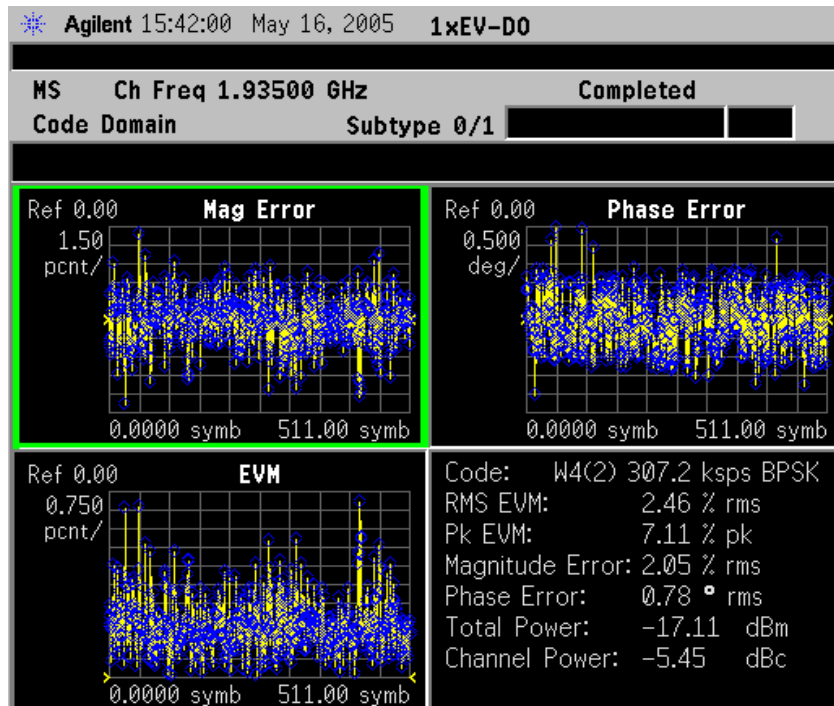


**Step 18.** Press the **View/Trace, I/Q Error (Quad View)** keys to display a four-pane view of the magnitude error, phase error, EVM and a summary of the measurement data for the code channels as set up in previous steps. The uppermost entry in the data summary pane for Code: W4(2) refers to the marked channel from the previous steps.

If your test signal has code channels on both I and Q code axes, you may need to change the setting of the I/Q Branch to get phase data displayed. Press **Meas Setup, I/Q Branch** and toggle the setting to **IQC** (I/Q Combined).

To change a display parameter like **AMPLITUDE Y Scale, Scale/Div** the window must be made “active”, which is shown on the display as the window with a green outline. Press **Next Window** to activate the other window, and **Zoom** to display only a single window.

**Figure 2-18** Reverse Link Code Domain Measurement - I/Q Error (Quad View)





**Step 19.** Press the **View/Trace, Code Domain (Quad View)** keys to display a four-pane view of the Code Domain Power, Symbol Power, a constellation diagram of the marked channel, and a summary of the measurement data for the code channels as set up in previous steps. The uppermost entry in the summary for Code: W4(2) refers to the marked channel from the previous steps.

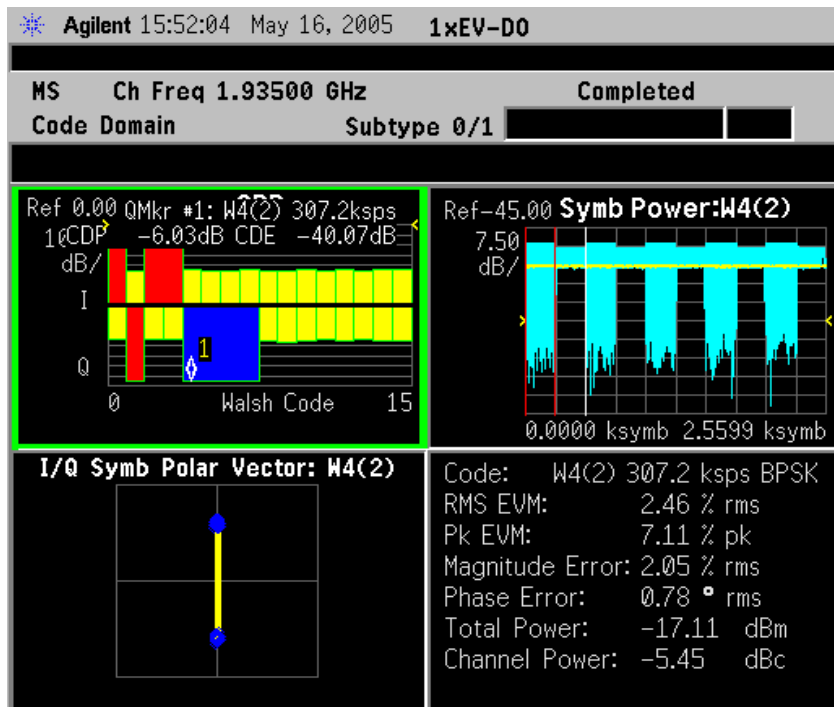
The Code Domain pane is a fully-functioning reduced display of the default view.

The Symbol Power display below shows the 5 successive bursts of each slot in the capture interval, the equivalent of 2.5599 ksymbols in time. The blue data is the composite chip or symbol powers across each slot. The blue trace can be turned on or off under the **Display** key. The vertical red lines indicate 1 slot. The vertical white line indicates the measurement interval (1 slot), including the idle between bursts. This can be increased to equal the capture interval. The yellow horizontal line indicates the individual chip power across the entire capture interval (5 slots). You can select another frame to be measured by setting the **Meas Offset** to another slot in the frame, the number being an integer offset (right) from the beginning of the capture interval.

To change a display parameter like **AMPLITUDE Y Scale, Scale/Div** the window must be made “active”, which is shown on the display as the window with a green outline. Press **Next Window** to activate the other window, and **Zoom** to display only a single window.

**Figure 2-19**

**Reverse Link Code Domain Measurement - I/Q Error (Quad View)**



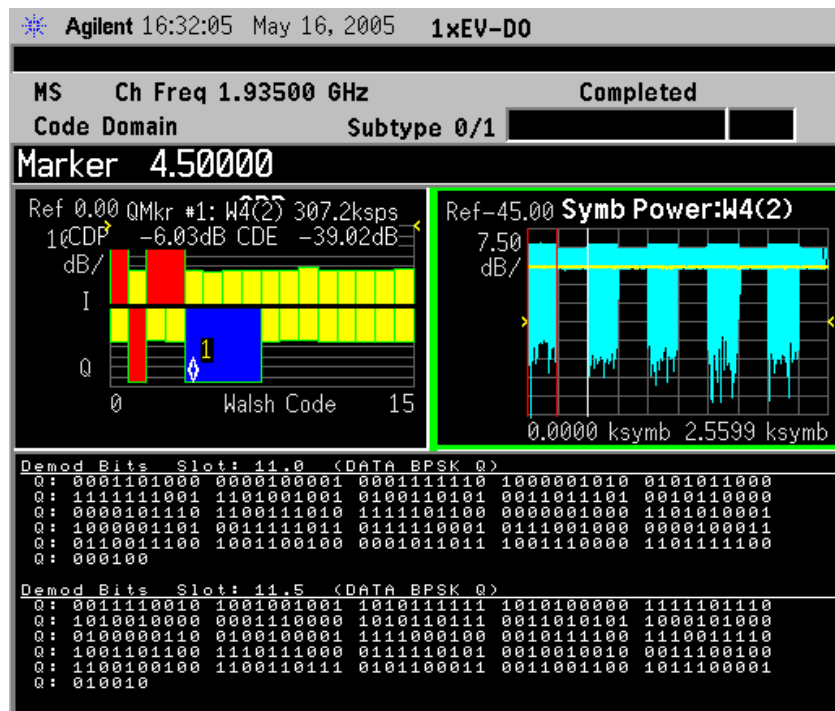
**Step 20.** Press the **View/Trace, Demod Bits** keys to display a tri-pane view of the Code Domain Power, Symbol Power, and the demodulated bits of the data code channels on the Q code branch. The bits shown are the bits from the measurement interval of 1 slot. The slot number from which the bits originate is shown above the data bit string. To view the demodulated bits of the I or IQC (I/Q Combined branches, Press **Meas Setup, I/Q Branch** and toggle the setting to **I** or **IQC**. To view the demodulated bits from more than one slot see the next step on [page 82](#).

The Code Domain pane is a fully-functioning reduced display of the default view.

The Symbol Power pane is a fully-functioning display as shown in the **Code Domain (Quad View)**.

To change a display parameter like **AMPLITUDE Y Scale, Scale/Div** the window must be made “active”, which is shown on the display as the window with a green outline. Press **Next Window** to activate the other window, and **Zoom** to display only a single window.

**Figure 2-20 Reverse Link Code Domain Measurement - Demod Bits View**



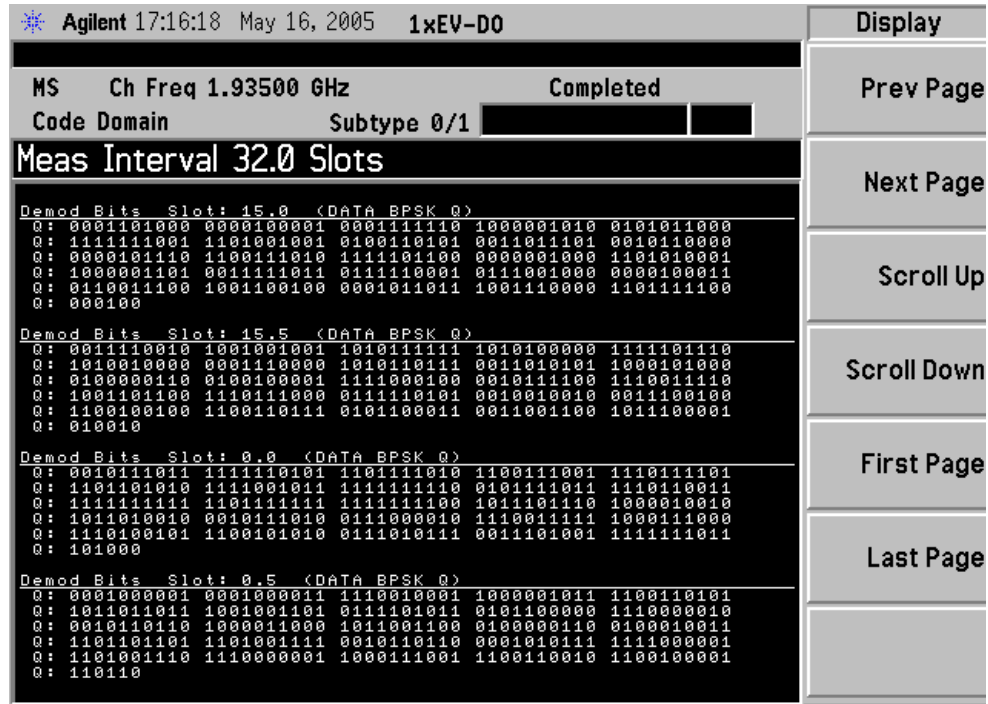
**Step 21.** Press the **Zoom** keys to expand the display of the demodulated bits of the data code channels. You can measure and demodulate as many as 16 slots, as long as the Capture Interval is greater than or equal to the Measurement Interval, in slots. You can increment either interval by 0.5 slots. The following example uses a **Meas Interval** of 32 slots, and a **Capture Interval** of 32 slots. Only 16 slots are demodulated (slots 0-15.5) and shown.

When you use **Zoom** to view the **Demod Bits** display you can access a menu under the **Display** key that allows you to navigate the entire contents of the demodulated bits data (see [Figure 2-21](#)).

When you use **Zoom** to view the **Demod Bits** display you can also access the **Print Setup**, **Print Demod** key that allows you to print the entire contents of the demodulated bits data, either by screen or in a report.

Figure 2-21

**Reverse Link Code Domain Measurement - Demod Bits Zoom View**



**Step 22.** Press the **Meas Control** key to change the **Measure** key from **Single** to **Cont.** The measurement and displayed data will be made repeatedly.

**Step 23.** Press the **Meas Setup**, **More (1 of 3)**, **More (2 of 3)** keys to check the keys available to change the measurement parameters from the default condition.

If you get an error message, see [“Understanding Common Measurement Errors”](#) on page 142.

## Troubleshooting Hints

Uncorrelated interference may cause CW interference like local oscillator feedthrough or spurs. Another uncorrelated noise may be due to I/Q modulation impairments. Correlated impairments can be due to the phase noise on the local oscillator in the upconverter or I/Q modulator of the UUT. These will be analyzed by the code domain measurements along with the QPSK EVM measurements and others.

A poor phase error indicates a problem at the I/Q baseband generator, filters, and/or modulator in the transmitter circuitry of the UUT. The output amplifier in the transmitter can also create distortion that causes unacceptably high phase error. In a real system, a poor phase error will reduce the ability of a receiver to correctly demodulate the received signal, especially in marginal signal conditions.

## Intermodulation Measurements

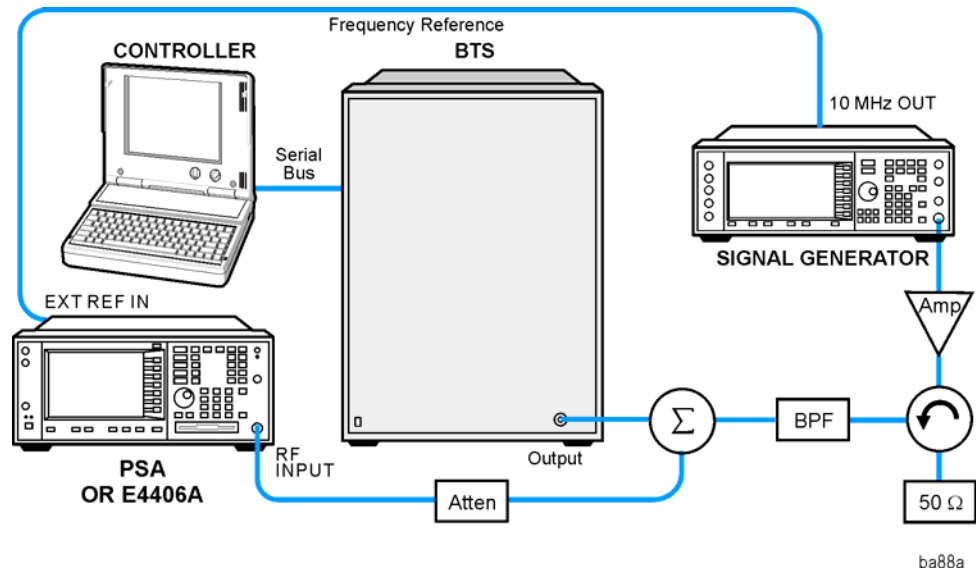
This section explains how to measure 1xEV-DO intermodulation products. The instrument, by default, measures the third- and fifth-order intermodulation products of the base frequency signal. Either two-tone or transmit intermodulation products are automatically identified.

### Configuring the Measurement System

The access network (BTS) under test has to be set to transmit the RF power remotely through the system controller. The 1xEV-DO modulated interference signal is injected at the antenna output port of the BTS through an amplifier and circulator. The transmitting signal from the BTS is summed with the interferer and connected to the instrument's RF input port. Connect the equipment as shown below:

Figure 2-22

### Intermodulation Products Measurement System



1. Using appropriate amplifier, circulators, etc., connect a 1xEV-DO carrier interference signal to the output connector of the BTS.
2. Connect the circulator output signal to the RF input port of the instrument through an attenuator.
3. Connect a BNC cable between the 10 MHz OUT port of the signal generator and the EXT REF IN port of the instrument.
4. Connect the system controller to the BTS with the serial bus cable.

## Setting the BTS and Signal Generator

From the system controller, perform all of the functions required for the BTS to transmit the RF signal. Also set the signal generator to output the 3 MHz offset carrier signal to make an intermodulation measurement with the transmit IM and tone signals.

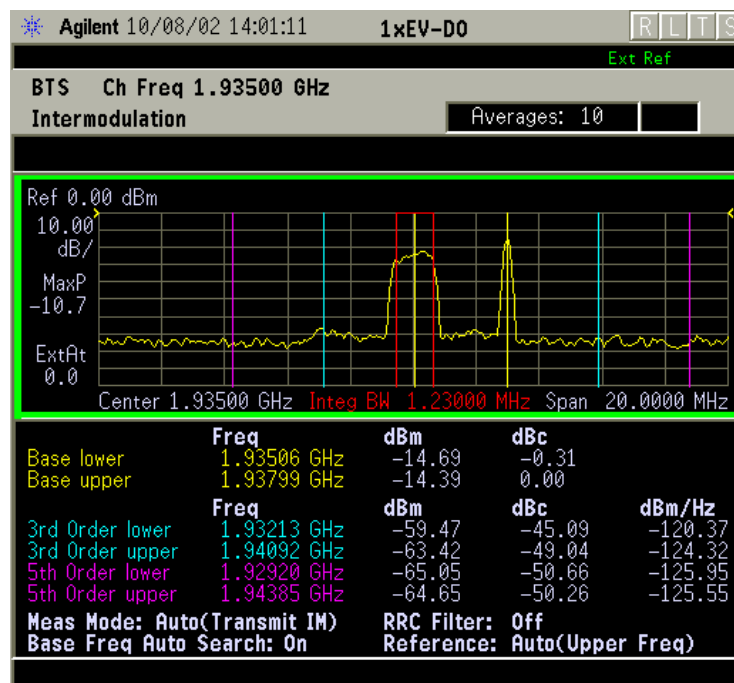
- **BTS (transmit intermodulation signal)**
  - Frequency: 1,935.000 MHz (preferred channel number 100)  
(=  $100 \times 0.050 + 1930.000$  MHz)
  - Output Power: Specified maximum output power level
- **Signal Generator (interference carrier signal)**
  - Frequency: 1,938.000 MHz (channel number 160)
  - Signal: CW (unmodulated carrier)
  - Output Power: Same level to the BTS output power at the BTS antenna output port

## Measurement Procedure

- Step 1.** Press the **Preset** key to preset the instrument.
- Step 2.** Press the **MODE, 1xEV-DO** keys to enable the 1xEV-DO measurements.
- Step 3.** Press the **Mode Setup, Input, Max Total Pwr** to enter the estimated maximum power from the BTS.
- Step 4.** Press the **Input Atten** and/or **Ext RF Atten** to enter the appropriate attenuation values depending on the estimated maximum power from the BTS.
- Step 5.** Press the **FREQUENCY Channel, 1935, MHz** keys to set the center frequency to 1,935.000 MHz.
- Step 6.** Press the **MEASURE, Intermod** keys to initiate the intermodulation measurement.

The Intermodulation measurement result should look like the next figure. The intermodulation products are graphically displayed in the graph window. The absolute and relative power levels along with the lower and upper power spectral density levels are shown in the text window.

**Figure 2-23** Intermodulation Measurement Result



- Step 7.** Press the **Meas Setup, More (1 of 2)** keys to check the keys available to change the measurement parameters from the default condition.

If you get an error message, see [“Understanding Common Measurement Errors”](#) on page 142.

## Troubleshooting Hints

Intermodulation distortion (IM) measurements can reveal the presence of degraded or defective parts in the transmitter section of the UUT. The following are examples of problems which, once indicated by IM testing, may require further attention:

- Faulty DC power supply control of the transmitter power amplifier.
- RF power controller of the pre-power amplifier stage.
- I/Q control of the baseband stage.
- Reduction in the gain and output power level of the amplifier due to a degraded gain control and/or increased distortion.
- Degradation of amplifier linearity and other performance characteristics.

Power amplifiers are one of the final stage elements of a base or mobile transmitter and play a critical part in meeting the important power and spectral efficiency specifications. Measuring the spectral response of these amplifiers to complex wideband signals is crucial to linking amplifier linearity and other performance characteristics to the stringent system specifications.



## Forward Link Modulation Accuracy (Composite Rho) Measurements

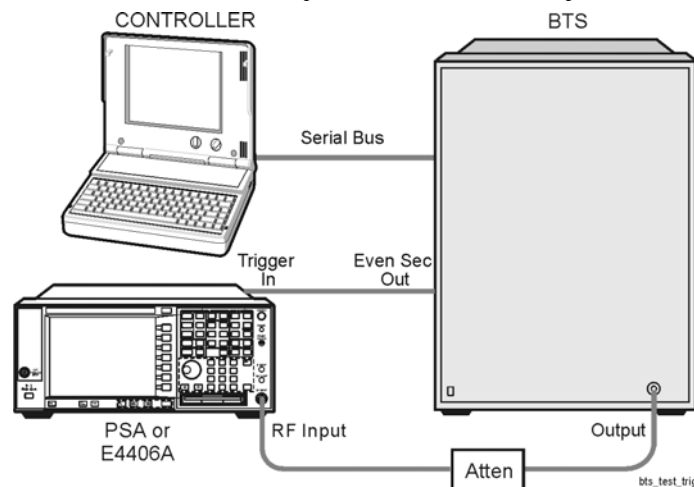
This section explains how to make a modulation accuracy (composite Rho) measurement on a 1xEV-DO base station. Rho is the ratio of the correlated power in a multi coded channel to the total signal power.

### Configuring the Measurement System

The access network (BTS) under test has to be set to transmit the RF power remotely through the system controller. This transmitting signal is connected to the instrument's RF input port. Connect the equipment as shown below:

Figure 2-24

### Modulation Accuracy Measurement System



1. Using the appropriate cables and attenuators, connect the output signal from the BTS to the RF input port of the instrument.
2. Connect the system controller to the BTS through the serial bus cable to control the BTS operation.
3. Connect an appropriate cable assembly between the TRIGGER IN connector of the instrument and the Even Sec Out connector of the BTS for synchronization.

## Setting the BTS

From the system controller, perform all of the functions required for the BTS to transmit the RF signal.

- **BTS**
  - Frequency: 1,935.000 MHz (preferred channel number 100)  
(=  $100 \times 0.050 + 1930.000$  MHz)
  - Output Power: Specified maximum output power level

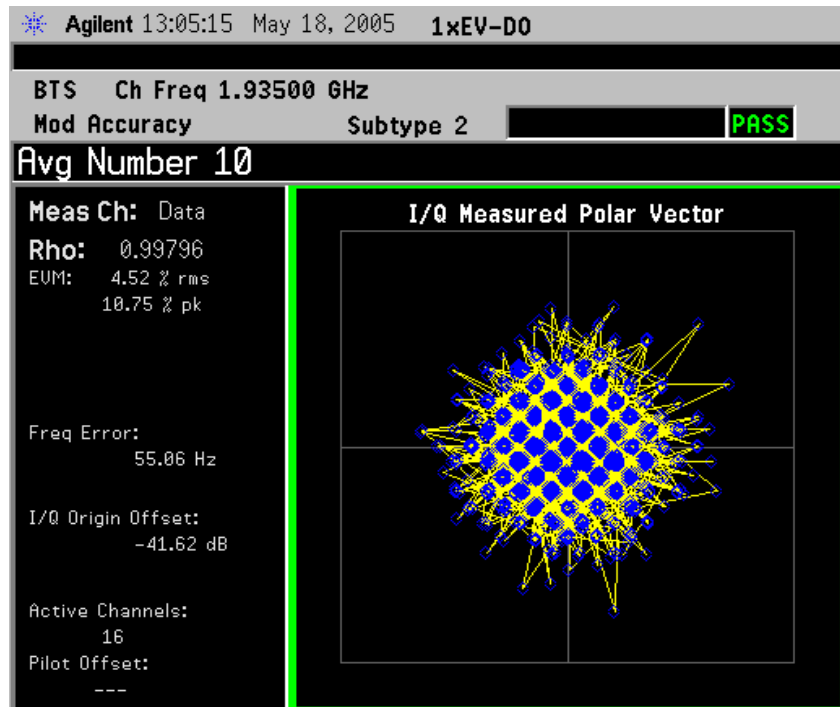
## Measurement Procedure

- Step 1.** Press the **Preset** key to preset the instrument.
- Step 2.** Press the **MODE, More (1 of 2), 1xEV-DO** keys to enable the 1xEV-DO measurements.
- Step 3.** Press the **Mode Setup, Input, Max Total Pwr** to enter the estimated maximum power from the BTS.
- Step 4.** Press the **Mode Setup, Demod** keys and toggle the **Physical Layer Subtype** selection to select either **0/1** or **2**.
- Step 5.** Press the **Input Atten** and/or **Ext RF Atten** to enter the appropriate attenuation values depending on the estimated maximum power from the BTS.
- Step 6.** Press the **FREQUENCY Channel, 1935, MHz** keys to set the center frequency to 1,935.000 MHz.
- Step 7.** Press the **MEASURE, More (1 of 2), Mod Accuracy (Composite Rho)** keys to initiate the measurement.

**Step 8.** Select a Code Channel Type for measurement, or measure the Modulation Accuracy of the Overall signal: Press **Meas Setup, Channel Type**, and then select your channel of interest. In the following example we will look at the **Data** channel.

The Meas Ch (Measured Channel) type, RHO, EVM, Freq Error, I/Q Origin Offset, and number of Active Channels is shown in the summary data pane to the left of the constellation window.

**Figure 2-25 Forward Link Modulation Accuracy Measurement Result - I/Q Measured Polar Vector View**



**Step 9.** Press the **View/Trace**, **Result Metrics** keys to display a summary of the measurement results for the Data channel, as selected.

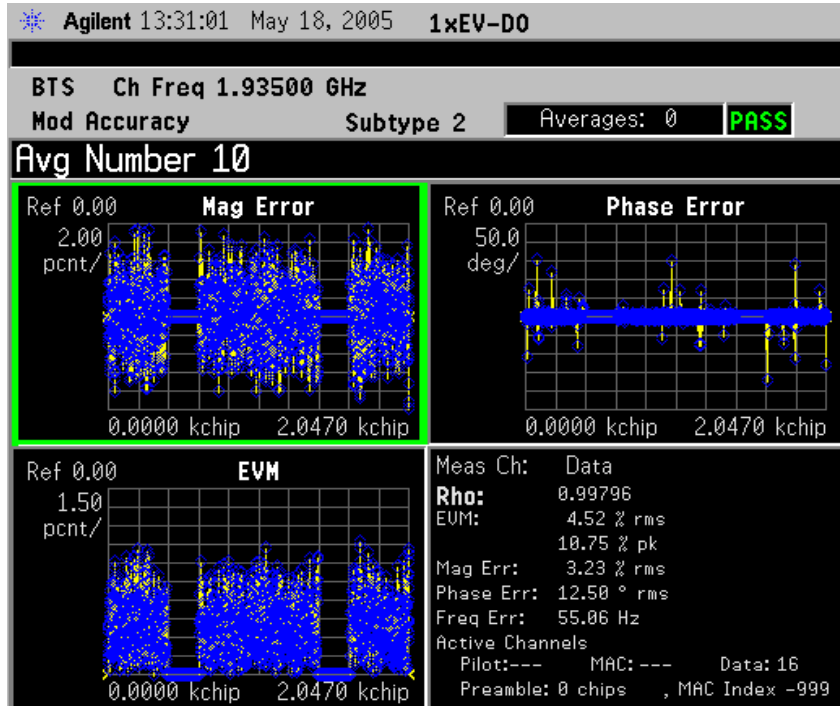
**Figure 2-26** Forward Link Modulation Accuracy Measurement Result - Result Metrics View

Code	Power (dB)	Timing (ns)	Phase (rad)
C4( 0)	-12.00	Reference	Reference
C4( 1)	-12.02	1.23	-0.010
C4( 2)	-12.06	1.08	-0.002
C4( 3)	-12.13	1.02	-0.007
C4( 4)	-12.18	-3.06	-0.004
C4( 5)	-12.03	-2.34	-0.003
C4( 6)	-12.03	-0.75	-0.003
C4( 7)	-12.05	0.21	0.002
C4( 8)	-11.97	-1.29	-0.001
C4( 9)	-12.04	0.47	-0.002
C4( 10)	-11.98	-2.19	0.001
C4( 11)	-12.14	0.19	-0.003
C4( 12)	-11.98	-1.54	-0.003
C4( 13)	-12.04	-1.15	-0.001
C4( 14)	-12.00	-1.06	0.001
C4( 15)	-12.02	-0.17	-0.001

The Peak values for each measured channel are shown in Yellow.

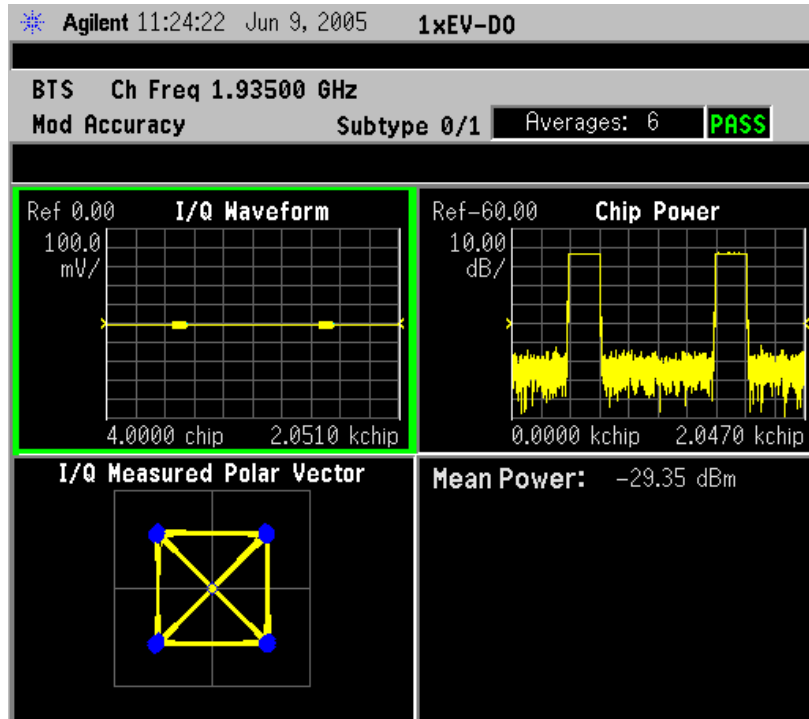
**Step 10.** Press the **View/Trace, I/Q Error (Quad View)** keys to display a combination view of the Magnitude Error, Phase Error, EVM graph windows, and the modulation data summary result window.

**Figure 2-27 Forward Link Modulation Accuracy Measurement Result - I/Q Error Quad View**



- Step 11.** Press the **View/Trace, I/Q Measured (Quad View)** keys to display a combination view of the I/Q waveform, chip power, polar vector graph windows, and the mean power result window.

**Figure 2-28** Forward Link Modulation Accuracy Measurement Result - I/Q Measured (Quad View)



- Step 12.** Press the **View/Trace, Power Timing & Phase** keys to observe the measured results in the text window. To make this observation, you may need to press the **Rho/EVM Channel Type** key to change to **Data**, and the **Multi Channel Estimator** (under the **Advanced** menu) key to turn on.

**Figure 2-29** Forward Link Modulation Accuracy Measurement - Power Timing & Phase View

Code	Power (dB)	Timing (ns)	Phase (rad)
C4( 0)	-12.00	Reference	Reference
C4( 1)	-12.02	1.23	-0.010
C4( 2)	-12.06	1.08	-0.002
C4( 3)	-12.13	1.02	-0.007
C4( 4)	-12.18	-3.06	-0.004
C4( 5)	-12.03	-2.34	-0.003
C4( 6)	-12.03	-0.75	-0.003
C4( 7)	-12.05	0.21	0.002
C4( 8)	-11.97	-1.29	-0.001
C4( 9)	-12.04	0.47	-0.002
C4( 10)	-11.98	-2.19	0.001
C4( 11)	-12.14	0.19	-0.003
C4( 12)	-11.98	-1.54	-0.003
C4( 13)	-12.04	-1.15	-0.001
C4( 14)	-12.00	-1.06	0.001
C4( 15)	-12.02	-0.17	-0.001

- Step 13.** Press the **Meas Setup, More (1 of 2)** keys to check the keys available to change the measurement parameters from the default condition.

If you get an error message, see [“Understanding Common Measurement Errors”](#) on page 142.

### Troubleshooting Hints

A poor phase error often indicates a problem with the I/Q baseband generator, filters, and/or modulator in the transmitter circuitry of the UUT. The output amplifier in the transmitter can also create distortion that causes unacceptably high phase error. In a real system, a poor phase error will reduce the ability of a receiver to correctly demodulate the received signal, especially in marginal signal conditions.

## Reverse Link Modulation Accuracy (Composite Rho) Measurements

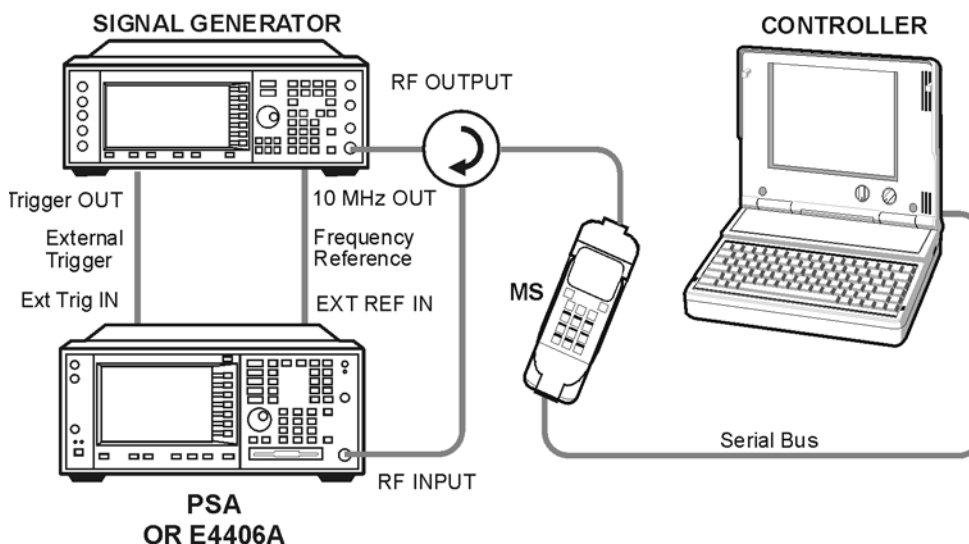
This section explains how to make a modulation accuracy (composite Rho) measurement on a 1xEV-DO base station. Rho is the ratio of the correlated power in a multi coded channel to the total signal power.

### Configuring the Measurement System

For configuring the measurement system, the access terminal (MS) under test has to be set to transmit the RF power remotely through the system controller. This transmitting signal is connected to the instruments RF input port. Connect the equipment as shown.

Figure 2-30

### Power Control Measurement System



1. Using the appropriate cables, adapters, and circulator, connect the output signal of the MS to the RF input of the instrument.
2. Connect the base transmission station simulator or signal generator to the MS through the circulator to initiate a link constructed with the sync and pilot channels, if required.
3. Connect a BNC cable between the 10 MHz OUT port of the signal generator and the EXT REF IN port of the instrument.
4. Connect a trigger signal from the signal generator or system controller and the EXT TRIG IN port of the instrument.
5. Connect the system controller to the MS through the serial bus cable to control the MS operation.



## Setting the MS

From the system controller, perform all of the functions required for the MS to transmit the RF signal.

Test Signal	Physical Layer Subtype 0 or 1 1 to 4 Active Channels: Pilot/RRI, DRC, ACK and Data
Frequency	1,935.000 MHz (preferred channel number 100) (1,935.000 = (100 × 0.050) + 1930.000 MHz)
Output Power:	Specified maximum output power level (Example power output set to 0 dBm)

## Measurement Procedure

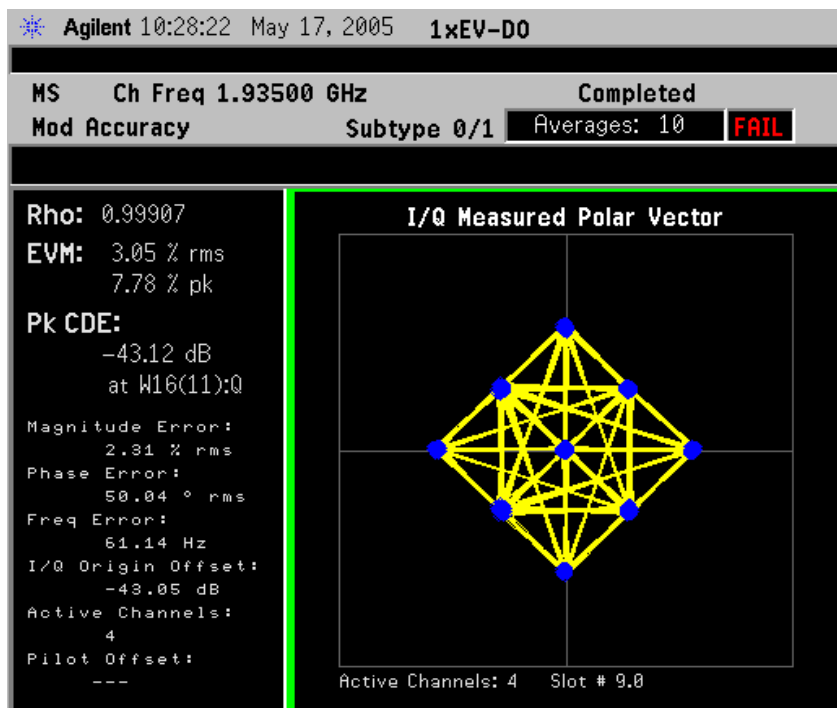
- Step 1.** Press the **Preset** key to preset the instrument.
- Step 2.** Press the **MODE, More (1 of 2), 1xEV-DO** keys to enable the 1xEV-DO measurements.
- Step 3.** Press the **Mode Setup, Radio, Device** keys to toggle the selection to **MS**.
- Step 4.** Press the **Mode Setup, Demod** keys and toggle the **Physical Layer Subtype** selection to select either **0/1** or **2**.
- Step 5.** Press the **Mode Setup, Input, Max Total Pwr** to enter the estimated maximum power from the MS.
- Step 6.** Press **Mode Setup, Demod**, and select the test signal **Physical Layer Subtype 0/1** or **2**.
- Step 7.** Press the **Input Atten** and/or **Ext RF Atten** to enter the appropriate attenuation values depending on the estimated maximum power from the MS.
- Step 8.** Press the **FREQUENCY Channel, 1935, MHz** keys to set the center frequency to 1,935.000 MHz.
- Step 9.** Press the **MEASURE, More (1 of 2), Mod Accuracy (Composite Rho)** keys to initiate the measurement.
- Step 10.** If your 1xEV-DO active channel signal is known, you may be able to take advantage of a predefined Active Channel preset for synchronization. Press **Meas Setup, More, Active Code Channel** and then press **Predefined**. Then press **Predefined Active Channel** and select from the list of predefined Active Channels shown.
- Step 11.** Press the **Meas Setup, More, I Long Code Mask** and enter the Hexadecimal long code for I.

**Step 12.** Press the **Meas Setup, More, Q Long Code Mask** and enter the Hexadecimal long code for Q.

The Mod Accuracy: I/Q Measured Polar Vector measurement result should look like the next figure. The measurement values for Reverse Link Modulation Accuracy are shown in the summary result window.

The number of Active Channels and the Slot Number is shown at the bottom of the Polar Vector window.

**Figure 2-31** Reverse Link Modulation Accuracy Measurement Result - Measured Polar Vector Graph (Default) View

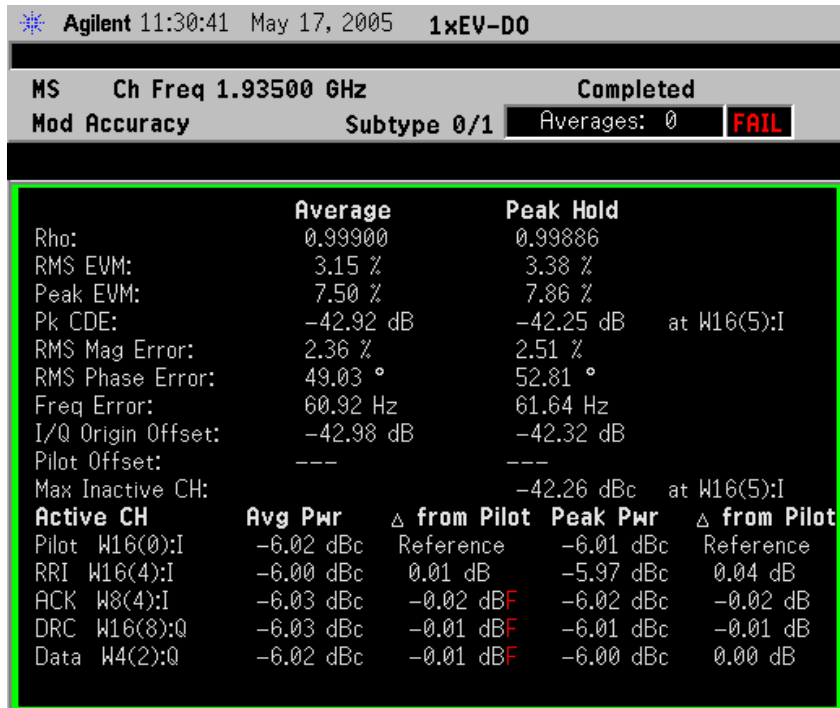


**NOTE**

In the example shown above, a measurement parameter has exceeded a set limit, so the **FAIL** result is shown above the Polar Vector window. The reason is not apparent in this view, but may be easily seen in the following view, Peak/Average Metrics.

**Step 13.** Press the **View/Trace, I/Q Error Peak/Average Metrics** keys to display a summary data view of all the parameters measured for the entire signal, as well as by active channel, including RHO, EVM, and magnitude, phase, and frequency errors.

**Figure 2-32 Reverse Link Modulation Accuracy Measurement Result - Peak/Average Metrics View**



The reason for the FAIL result obtained and displayed in the previous view is now obvious, as the ACK, DRC, and Data channels “Δ from Pilot” average results are incompatible with the PASS Limits set, and are marked with a red “F”.

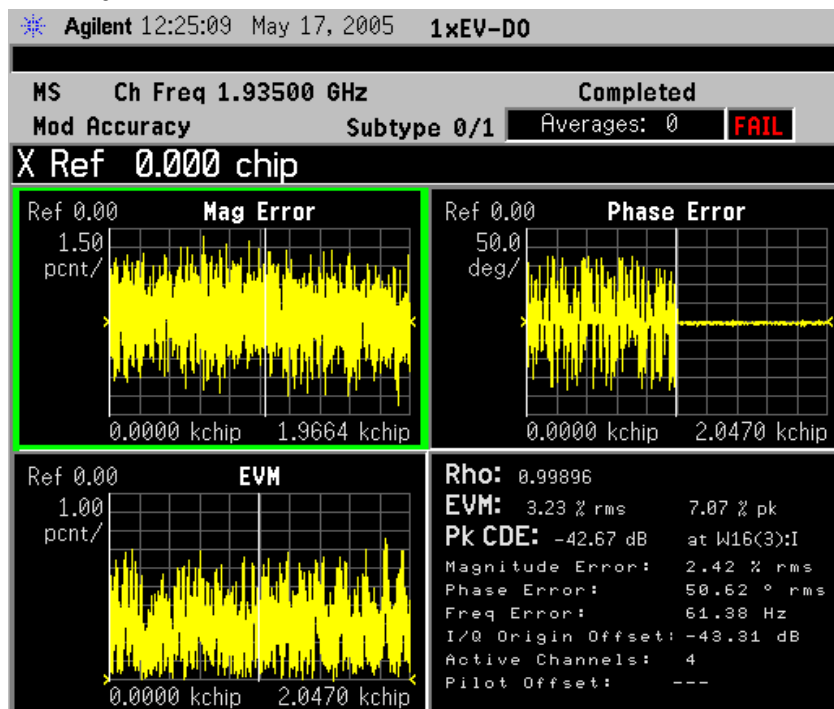
You can adjust the Limits of the PASS/FAIL test by pressing **Meas Setup, Limits** and adjusting the values entered from the settings required by the standards (if any) to suit your particular application. In general, values for which no standard exists are set to provide very wide tolerance of acceptance.

**NOTE**

To obtain values for the individual Active Channels demodulated as shown above, you may need to adjust the slot portion subjected to averaging. Press **Meas Setup, Avg Slots** and select the portion of the slot to be averaged, either the **1st Half Slot** (default), **2nd Half Slot**, or the **Full Slot**. Full slot may not provide any result for Active Channels not active during the entire slot. You may also intentionally exclude one half of the slot from averaging by selecting the appropriate setting.

- Step 14.** Press the **View/Trace, I/Q Error (Quad View)** keys to display a combination view of the magnitude error, phase error, EVM graph windows, and the modulation summary result window.

**Figure 2-33** Reverse Link Modulation Accuracy Measurement Result - I/Q Error Quad View



To change a display parameter like **AMPLITUDE Y Scale, Scale/Div** the window must be made “active”, which is shown on the display as the window with a green outline. Press **Next Window** to activate the other window, and **Zoom** to display only a single window.

To use markers on any of the traces in the Quad-View above, press **Marker, Trace** and select the trace of interest.

**Step 15.** Press the **View/Trace, Code Domain Power** keys to display a combination view of the Code Domain Power graph and the measurement results of each Active Channel in a summary result window.

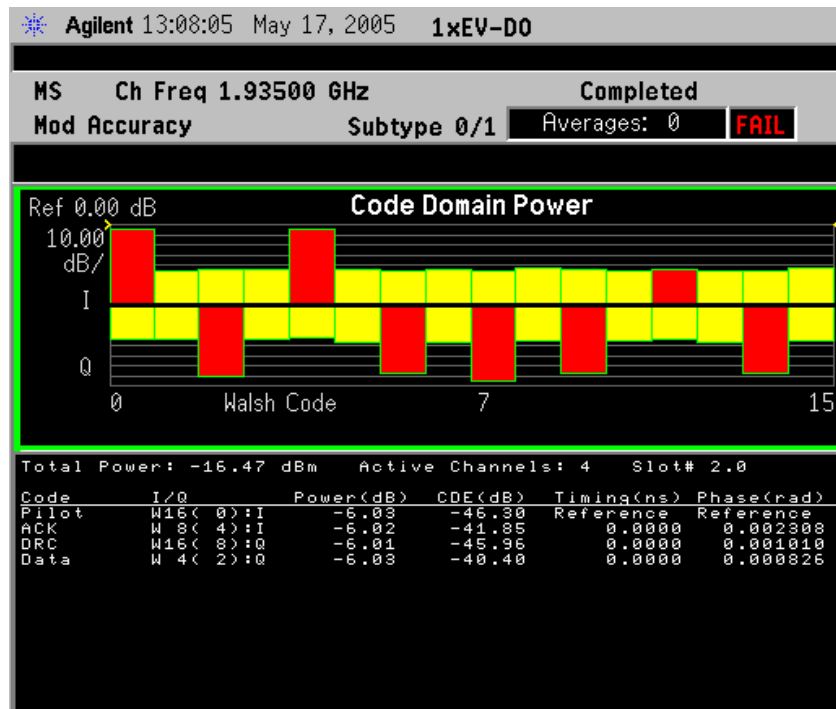
**NOTE**

If your signal has more than 1 Active Channel, you may get an instrument message prompting you to turn on the “Multi Channel Estimator” to obtain Phase and Timing data. Press **Meas Setup, More 1 of 3, More 2 of 3, Advanced, More 1 of 2**, and toggle **Multi Channel Estimator to On**. If you are not interested in Phase or Timing data, the measurement will run faster with the Multi Channel Estimator Off.

To use markers on the CDP bar graph, press **Marker, Trace** and select **Code Domain Power**.

**Figure 2-34**

**Reverse Link Modulation Accuracy Measurement Result - I/Q Error Quad View**



To change a display parameter like **AMPLITUDE Y Scale, Scale/Div** the window must be made “active”, which is shown on the display as the window with a green outline. Press **Next Window** to activate the other window, and **Zoom** to display only a single window.

**Step 16.** Press the **Meas Setup, More (1 of 2)** keys to check the keys available to change the measurement parameters from the default condition.

If you get an error message, see “[Understanding Common Measurement Errors](#)” on page 142.

## Troubleshooting Hints

A poor phase error often indicates a problem with the I/Q baseband generator, filters, and/or modulator in the transmitter circuitry of the UUT. The output amplifier in the transmitter can also create distortion that causes unacceptably high phase error. In a real system, a poor phase error will reduce the ability of a receiver to correctly demodulate the received signal, especially in marginal signal conditions.

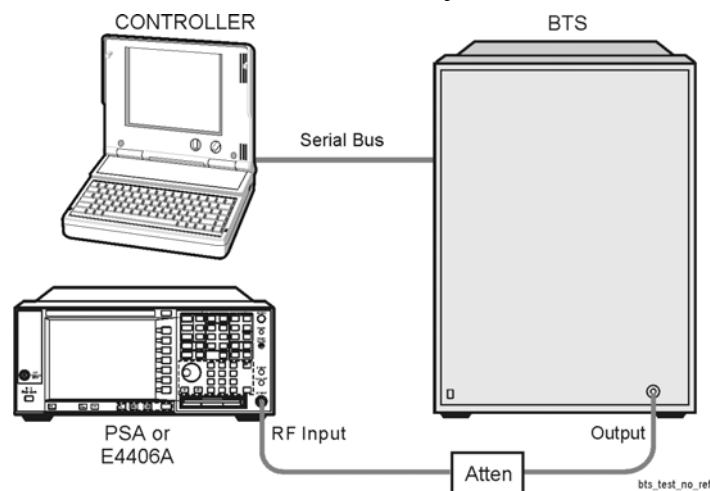
## Occupied Bandwidth Measurements

This section explains how to make an occupied bandwidth measurement on a 1xEV-DO base station. The tester measures power across the band, and then calculates its 99.0% power bandwidth.

### Configuring the Measurement System

The access network (BTS) under test has to be set to transmit the RF power remotely through the system controller. This transmitting signal is connected to the instrument's RF input port. Connect the equipment as shown below:

**Figure 2-35** Occupied Bandwidth Measurement System



1. Using the appropriate cables and attenuators, connect the output signal from the BTS to the RF input port of the instrument.
2. Connect the system controller to the BTS through the serial bus cable to control the BTS operation.

### Setting the BTS

From the system controller, perform all of the functions required for the BTS to transmit the RF signal.

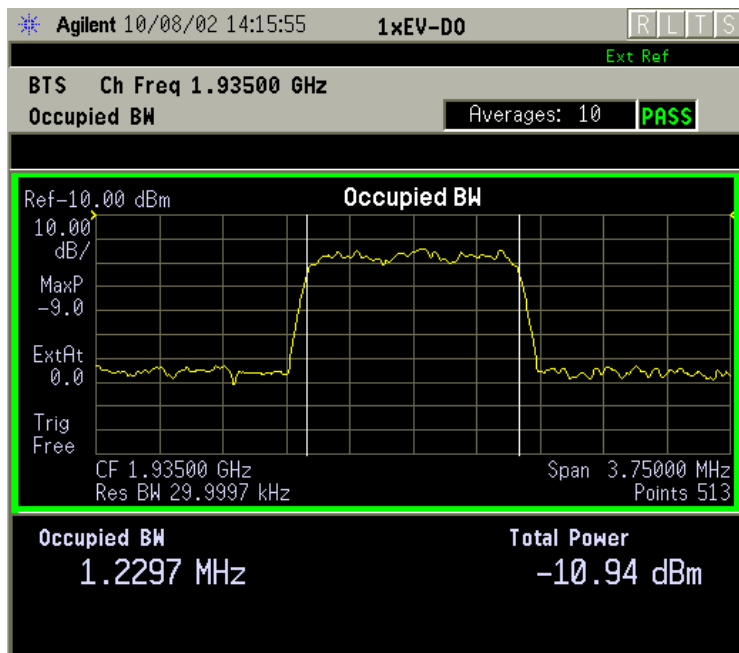
- BTS
  - Frequency      1,935.000 MHz (preferred channel number 100)  
(1,935.000 = (100 × 0.050) + 1930.000 MHz)
  - Output Power: Specified maximum output power level

## Measurement Procedure

- Step 1.** Press the **Preset** key to preset the instrument.
- Step 2.** Press the **MODE, More (1 of 2), 1xEV-DO** keys to enable the 1xEV-DO measurements.
- Step 3.** If your UUT is a MS, Press the **Mode Setup, Radio, Device** keys to toggle the selection to **MS**.
- Step 4.** Press the **Mode Setup, Input, Max Total Pwr** to enter the estimated maximum power from the BTS.
- Step 5.** Press the **Input Atten** and/or **Ext RF Atten** to enter the appropriate attenuation values depending on the estimated maximum power from the BTS.
- Step 6.** Press the **FREQUENCY Channel, 1935, MHz** keys to set the center frequency to 1,935.000 MHz.
- Step 7.** Press the **MEASURE, Occupied BW** keys to initiate the occupied bandwidth measurement.

The Occupied BW measurement result should look like the next figure. A graph window with text showing the occupied bandwidth and the absolute total power level are displayed.

**Figure 2-36** Occupied Bandwidth Measurement Result



- Step 8.** Press the **Meas Setup, More (1 of 2)** keys to check the keys available to change the measurement parameters from the default condition.

If you get an error message, see [“Understanding Common](#)



Measurement Errors” on page 142.

### **Troubleshooting Hints**

Any distortion such as harmonics or intermodulation, for example, produces undesirable power outside the specified bandwidth.

Shoulders on either side of the spectrum shape indicate spectral regrowth and intermodulation. Rounding or sloping of the top shape can indicate filter shape problems.

## Power Statistics CCDF Measurements

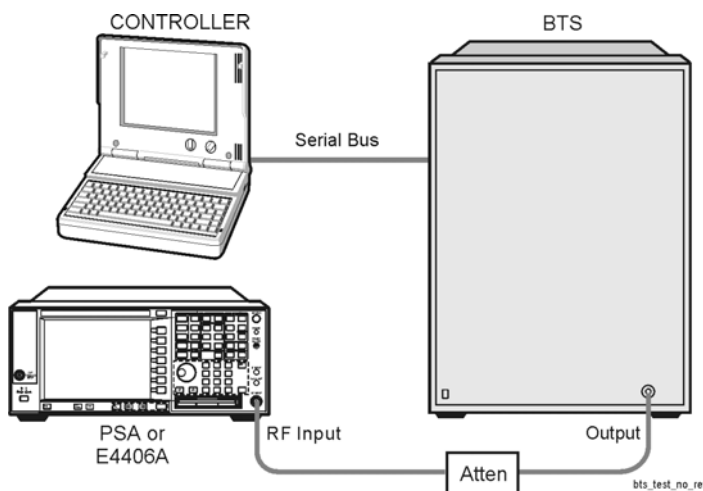
This section explains how to make a Power Statistics Complementary Cumulative Distribution Function (Power Stat CCDF) measurement on a 1xEV-DO base station. Power Stat CCDF curves characterize the higher level power statistics of a digitally modulated signal.

### Configuring the Measurement System

The access network (BTS) under test has to be set to transmit the RF power remotely through the system controller. This transmitting signal is connected to the instrument's RF input port. Connect the equipment as shown below:

Figure 2-37

Power Statistics (CCDF) Measurement System



1. Using the appropriate cables and attenuators, connect the output signal from the BTS to the RF input port of the instrument.
2. Connect the system controller to the BTS through the serial bus cable to control the BTS operation.

### Setting the BTS

From the system controller, perform all of the functions required for the BTS to transmit the RF signal.

- BTS
  - Frequency 1,935.000 MHz (preferred channel number 100)  
(1,935.000 = (100 × 0.050) + 1930.000 MHz)
  - Output Power: Specified maximum output power level

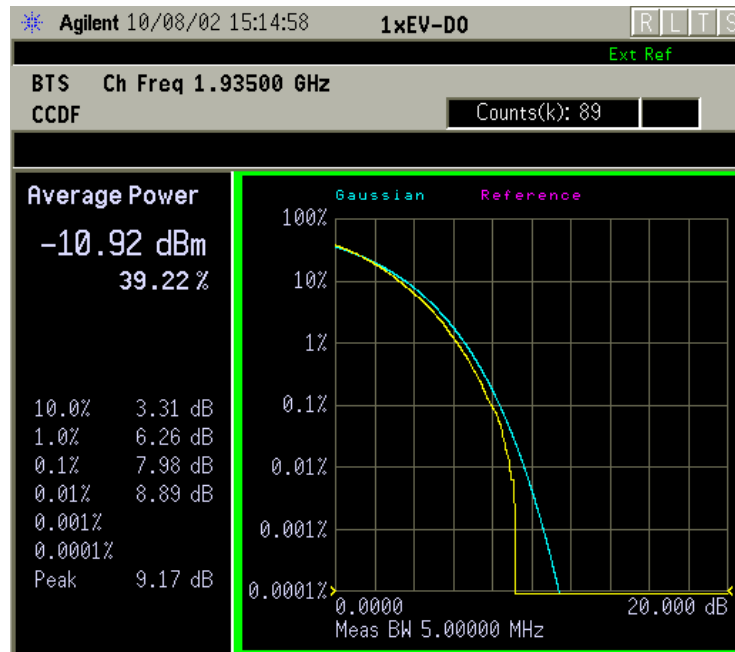
## Measurement Procedure

- Step 1.** Press the **Preset** key to preset the instrument.
- Step 2.** Press the **MODE, More (1 of 2), 1xEV-DO** keys to enable the 1xEV-DO measurements.
- Step 3.** If your UUT is a MS, Press the **Mode Setup, Radio, Device** keys to toggle the selection to **MS**.
- Step 4.** Press the **Mode Setup, Input, Max Total Pwr** to enter the estimated maximum power from the BTS.
- Step 5.** Press the **Input Atten** and/or **Ext RF Atten** to enter the appropriate attenuation values depending on the estimated maximum power from the BTS.
- Step 6.** Press the **FREQUENCY Channel, 1935, MHz** keys to set the center frequency to 1,935.000 MHz.
- Step 7.** Press the **MEASURE, More (1 of 2), Power Stat CCDF** keys to initiate the power statistics CCDF measurement.

The CCDF measurement result should look like the next figure. The measurement result values are shown in the summary result window.

**Figure 2-38**

### Power Statistics CCDF Measurement Result



- Step 8.** Press the **Meas Setup, More (1 of 2)** keys to check the keys available to change the measurement parameters from the default condition.

If you get an error message, see [“Understanding Common Measurement Errors”](#) on page 142.

## Troubleshooting Hints

The power statistics CCDF measurement can help in determining the signal power specifications used as design criteria for systems, amplifiers, and other components. For example, it can help determine the optimum operating point to adjust code timing for appropriate peak/average power ratio throughout the wide channel bandwidth of the transmitter for a 1xEV-DO system.

As this measurement becomes more widely used the correlation between CCDF curve degradation and digital radio system measurement parameters such as BER, FER, code domain power, and ACPR will become more established. Further studies will eventually yield standards for radio design by specifying the maximum allowed CCDF curve degradation for specific systems.

As this measurement becomes more widely used the correlation between CCDF curve degradation and digital radio system measurement parameters such as BER, FER, code domain power, and ACPR will become more established. Further studies will eventually yield standards for radio design by specifying the maximum allowed CCDF curve degradation for specific systems.

## Power versus Time Measurements

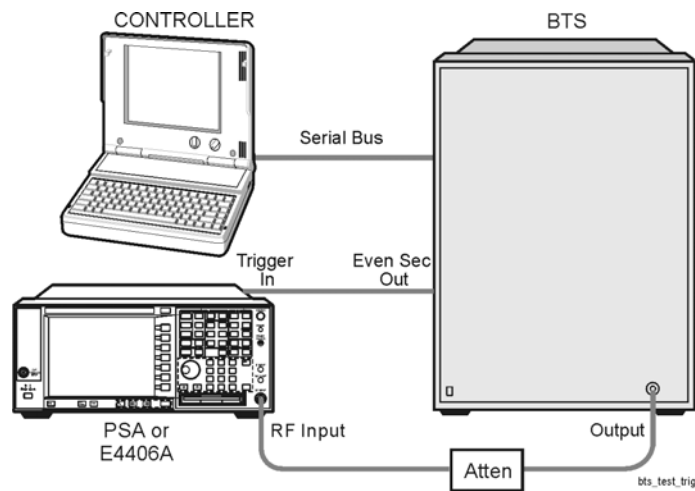
This section explains how to measure 1xEV-DO power versus time. The instrument, by default, measures the power versus time of the idle slot type.

### Configuring the Measurement System

The access network (BTS) under test has to be set to transmit the RF power remotely through the system controller. The transmitting signal from the BTS is connected to the instrument's RF input port. Connect the equipment as shown below:

Figure 2-39

### Power versus Time Measurement System



1. Connect the BTS output signal to the RF input port of the instrument through an attenuator.
2. Connect the system controller to the BTS with the serial bus cable.
3. Connect an appropriate cable assembly between the TRIGGER IN connector of the instrument and the Even Sec Out connector of the BTS for synchronization.

### Setting the BTS

From the system controller, perform all of the functions required for the BTS to transmit the RF signal.

- BTS
  - Frequency      1,935.000 MHz (preferred channel number 100)  
(1,935.000 = (100 × 0.050) + 1930.000 MHz)
  - Output Power: Specified maximum output power level

## Measurement Procedure

- Step 1.** Press the **Preset** key to preset the instrument.
- Step 2.** Press the **MODE, 1xEV-DO** keys to enable the 1xEV-DO measurements.
- Step 3.** If your UUT is a MS, Press the **Mode Setup, Radio, Device** keys to toggle the selection to **MS**.
- Step 4.** Press the **Mode Setup, Input, Max Total Pwr** to enter the estimated maximum power from the BTS.
- Step 5.** Press the **Input Atten** and/or **Ext RF Atten** to enter the appropriate attenuation values depending on the estimated maximum power from the BTS.
- Step 6.** Make sure the analyzer is set to synchronize to the trigger input signal.

---

**NOTE**

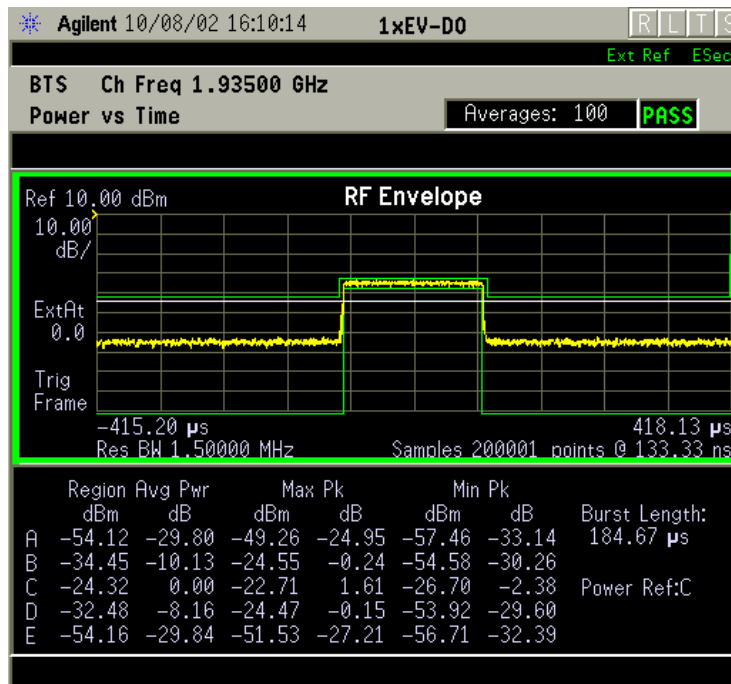
Accurate PvT measurements of burst signals require the analyzer to be perfectly synchronized with the signal of interest. This is usually accomplished through use of the measurement Trigger function. For more details about the Trigger, see [“Using the Waveform Measurement to Set Up Triggering \(for burst signals\)”](#) on page 140 and [“Trigger Key Menu”](#) on page 154.

---

- Step 7.** Press the **FREQUENCY Channel, 1935, MHz** keys to set the center frequency to 1,935.000 MHz.
- Step 8.** Press the **MEASURE, Power vs. Time** keys to initiate the power versus time measurement.

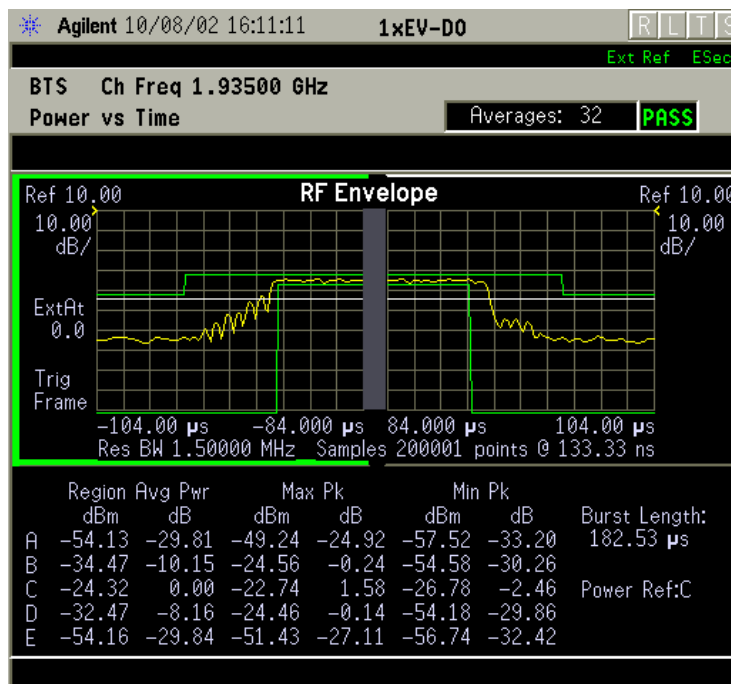
The Power vs. Time or RF Envelope measurement result should look like the next figure. The burst power and the region masks are graphically displayed in the graph window. The absolute power levels along with the maximum and minimum current data are shown in the text window.

**Figure 2-40** Power Vs. Time Measurement Result - RF Envelope (Default) View



**Step 9.** Press the **View/Trace** and **Rise & Fall** keys to obtain the horizontally expanded rising and falling edges as shown below:

**Figure 2-41** Power Vs. Time Measurement Result - Rise and Fall View



**Step 10.** Press the **Meas Setup, More (1 of 2)** keys to check the keys available to

change the measurement parameters from the default condition.

If you get an error message, see [“Understanding Common Measurement Errors”](#) on page 142.

## Troubleshooting Hints

This power versus time measurement can reveal degraded or defective parts in the transmitter section of the UUT. The following examples are those areas to be checked further.

- Some faults in the DC power supply control of the transmitter power amplifier, RF power controller of the pre-power amplifier stage, or I/Q control of the baseband stage
- Some degradation in the gain and output power level of the amplifier due to the degraded gain control and/or increased distortion
- Some degradation of the amplifier linearity and other performance characteristics

Power amplifiers are one of the final stage elements of a base or mobile transmitter and are a critical part of meeting the important power and spectral efficiency specifications. Since PvT measures the time domain response of the amplifier to a complex wideband signal, it is a key measurement linking amplifier linearity and other performance characteristics to the stringent system specifications.



## QPSK EVM Measurements

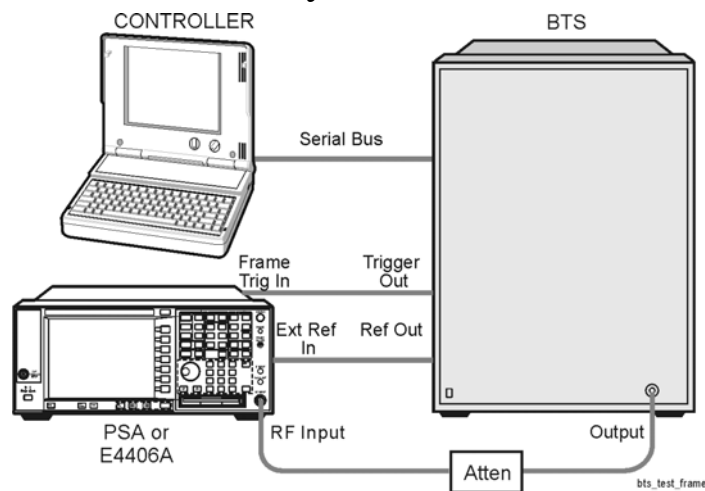
This section explains how to make a quadrature phase shift keying (QPSK) error vector magnitude (EVM) measurement on a 1xEV-DO base station. QPSK EVM is a measure of phase and amplitude modulation quality that relates the performance of the actual signal compared to an ideal signal as a percentage, as calculated over the course of the ideal constellation.

### Configuring the Measurement System

The access network (BTS) under test has to be set to transmit the RF power remotely through the system controller. This transmitting signal is connected to the instrument's RF input port. Connect the equipment as shown below:

**Figure 2-42**

### QPSK EVM Measurement System



1. Using the appropriate cables and attenuators, connect the output signal from the BTS to the RF input port of the instrument.
2. Connect the system controller to the BTS through the serial bus cable to control the BTS operation.
3. Connect an appropriate cable assembly between the FRAME TRIG IN connector of the instrument and the trigger output connector of the BTS.
4. Connect an appropriate cable assembly between the EXT REF IN connector of the instrument and the reference output connector of the BTS.

## Setting the BTS

From the system controller, perform all of the functions required for the BTS to transmit the RF signal.

- BTS

Channel Configuration Pilot Only or MAC combined idle slot

Frequency 1,935.000 MHz (preferred channel number 100)  
( $1,935.000 = (100 \times 0.050) + 1930.000$  MHz)

Output Power: Specified maximum output power level

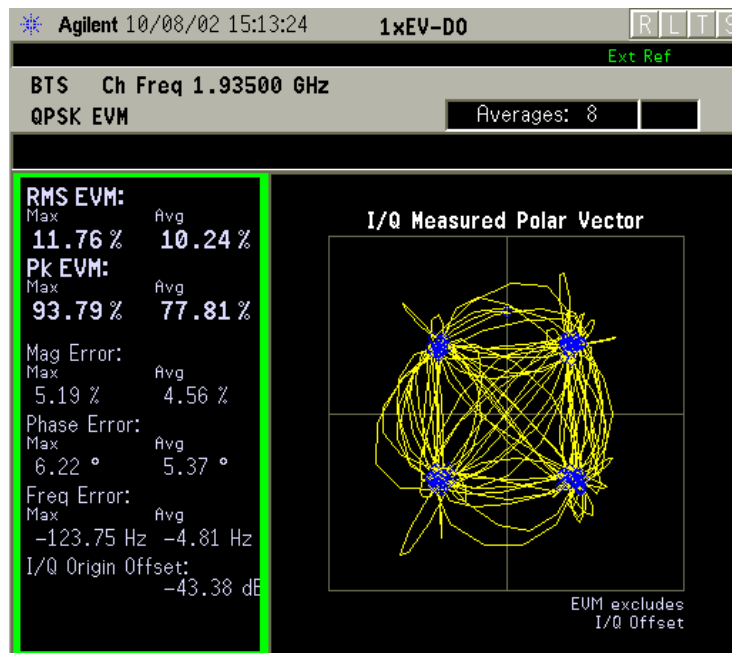
## Measurement Procedure

- Step 1.** Press the **Preset** key to preset the instrument.
- Step 2.** Press the **MODE, More (1 of 2), 1xEV-DO** keys to enable the 1xEV-DO measurements.
- Step 3.** If your UUT is a MS, Press the **Mode Setup, Radio, Device** keys to toggle the selection to **MS**.
- Step 4.** Press the **Mode Setup, Input, Max Total Pwr** to enter the estimated maximum power from the BTS.
- Step 5.** Press the **Input Atten** and/or **Ext RF Atten** to enter the appropriate attenuation values depending on the estimated maximum power from the BTS.
- Step 6.** Press the **FREQUENCY Channel, 1935, MHz** keys to set the center frequency to 1,935.000 MHz.
- Step 7.** Press the **MEASURE, More (1 of 2), QPSK EVM** keys to set the instrument to initiate the QPSK EVM measurement.

The QPSK EVM: I/Q Measured Polar Vector measurement result should look like the next figure. The measurement values for Reverse Link Modulation Accuracy are shown in the summary result window.

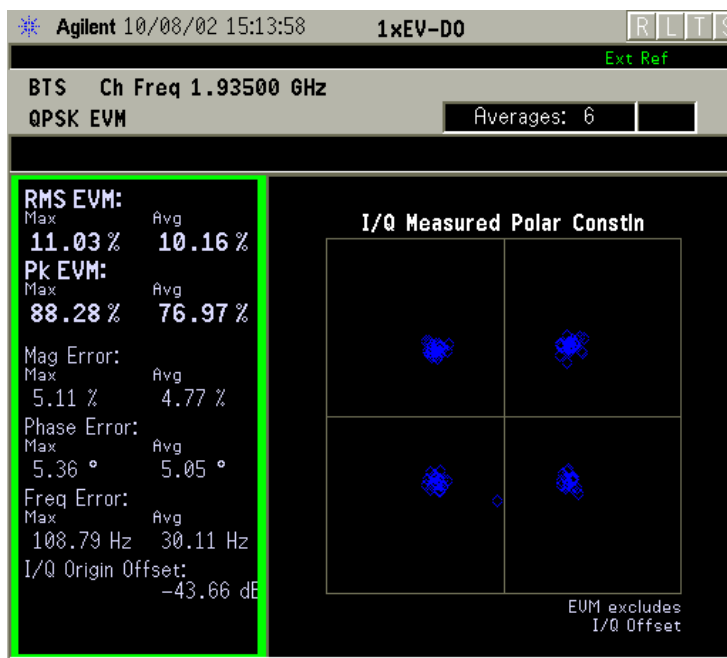
Figure 2-43

QPSK EVM Measurement Result - Polar Vector (Default) View



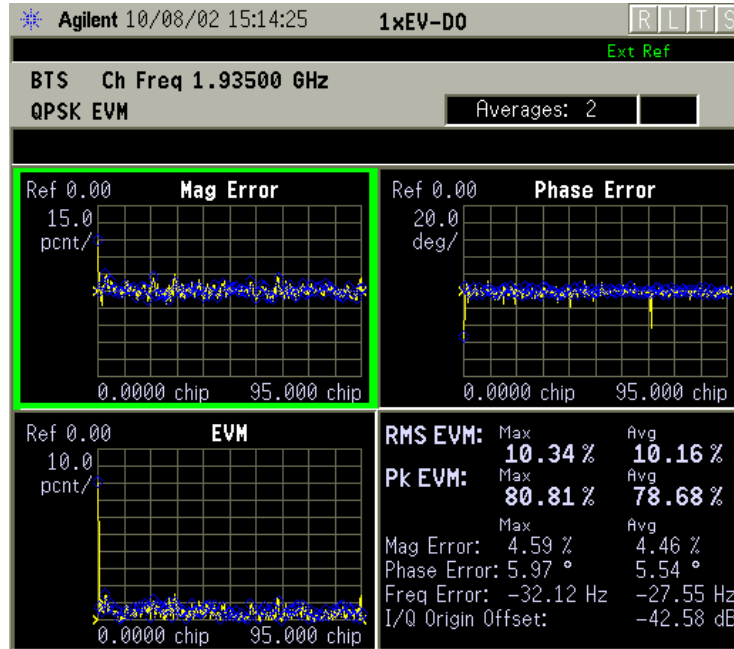
**Step 8.** Press the **View/Trace, I/Q Measured Polar Constln** keys to display a combination view of the I/Q measured polar constellation graph window and the modulation summary result window.

**Figure 2-44** QPSK EVM Measurement Result - Polar Constellation View



**Step 9.** Press the **View/Trace, I/Q Error (Quad View)** keys to display a combination view of the magnitude error, phase error, and EVM graph windows, and the modulation summary result window.

**Figure 2-45** QPSK EVM Measurement Result - I/Q Error Quad View



**Step 10.** Press the **Meas Setup, More (1 of 2)** keys to check the keys available to change the measurement parameters from the default condition.

If you get an error message, see [“Understanding Common Measurement Errors”](#) on page 142.

## Spectrum (Frequency Domain) Measurements

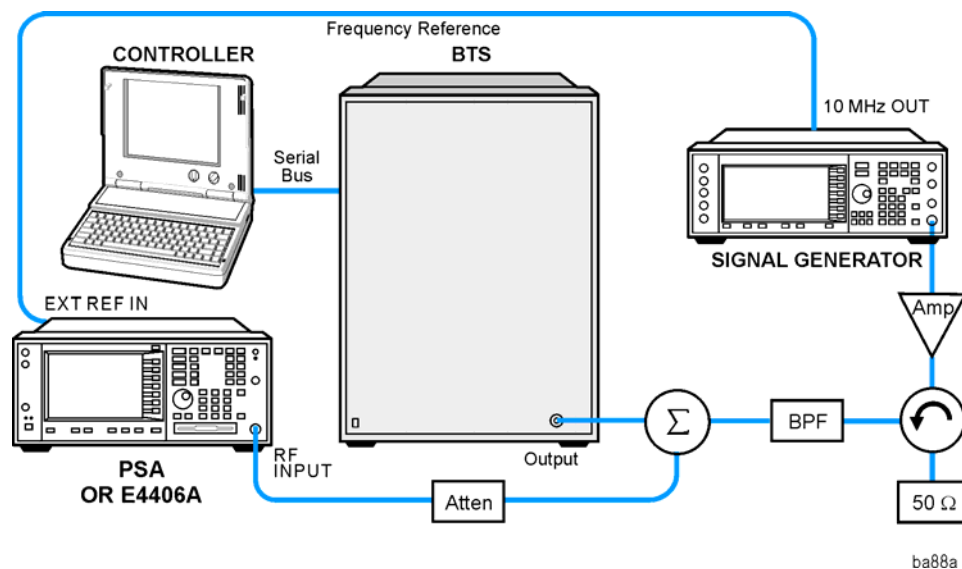
This section explains how to make a frequency domain measurement on a 1xEV-DO base station. An adjacent or an interfering signal can also be applied, if desired, during spectrum measurements.

If installed, you may use PSA Option 122, the 80 MHz Bandwidth Digitizer hardware, or PSA Option 140, the 40 MHz Bandwidth Digitizer hardware to perform Waveform measurements of wideband signals using Basic Mode or PSA Option 241, Flexible Digital Modulation Analysis mode.

### Configuring the Measurement System

This example shows a base station (BTS) under test set up to transmit RF power, and being controlled remotely by a system controller. The transmitting signal is connected to the analyzer RF input port. Connect the equipment as shown.

**Figure 2-46** Spectrum Measurement System



1. Using the appropriate cables, adapters, and circulator, connect the output signal of the BTS to the RF input of the instrument.
2. Connect the base transmission station simulator or signal generator to the BTS through a circulator to initiate a link constructed with sync and pilot channels, if required.
3. Connect a BNC cable between the 10 MHz OUT port of the signal generator and the EXT REF IN port of the instrument.
4. Connect the system controller to the BTS through the serial bus cable to control the BTS operation.

## Setting the BTS

From the system controller, perform all of the functions required for the BTS to transmit the RF signal.

- **BTS**

Channel Configuration Pilot Only or MAC combined idle slot

Frequency 1,935.000 MHz (preferred channel number 100)  
(1,935.000 = (100 × 0.050) + 1930.000 MHz)

Output Power: Specified maximum output power level

## Measurement Procedure

- Step 1.** Press the **Preset** key to preset the instrument.
- Step 2.** Press the **MODE**, 1xEV-DO keys to enable the 1xEV-DO Mode measurements.
- Step 3.** To set the measurement center frequency press the **FREQUENCY Channel** key, enter a numerical frequency using the front-panel keypad, and complete the entry by selecting a units key, like **MHz**.
- Step 4.** Press the **SPAN** key, enter a numerical span using the front-panel keypad, and press the **MHz** key to set the measurement span in MHz.
- Step 5.** Press the **MEASURE** to initiate the spectrum measurement, which is the default measurement for 1xEV-DO.

---

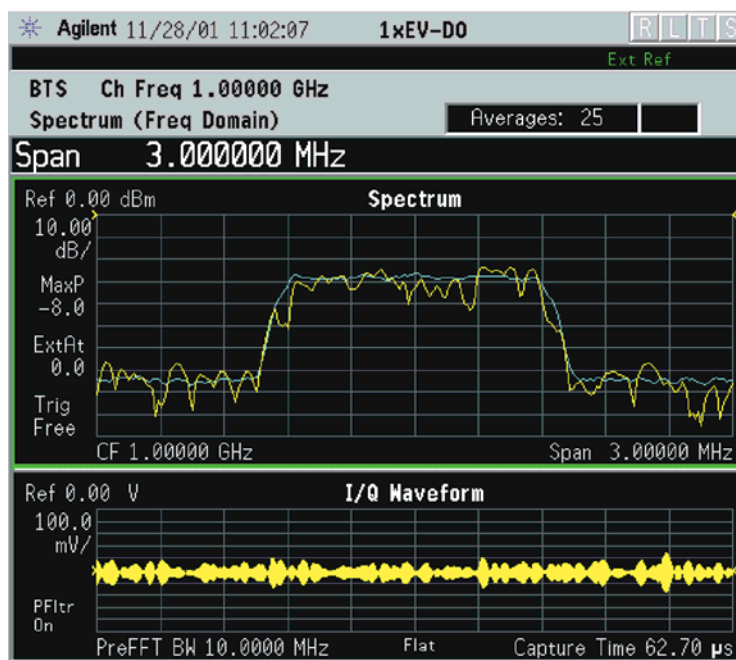
### NOTE

A display with both a Spectrum window and an I/Q Waveform window will appear when you activate a Spectrum measurement. The active window is outlined in green. Changes to **FREQUENCY**, **Span**, or **Amplitude** settings will affect only the active window. Use the **Next Window** key to select a different window, and the **Zoom** key to enlarge a window.

The default display shows both **Current** (yellow trace) and **Average** (blue trace) data. To make viewing the display easier, you can view either the **Current** trace or **Average** separately.

- Press **Trace/View**, **Trace Display**, and select the trace(s) desired for display.

**Figure 2-47** Spectrum Measurement - Spectrum and I/Q Waveform (Default View)



\*Meas Setup: Span = 3.000 MHz, Capture Time = 62.70 μs,  
Others = Factory default settings

\*Input signal: -10.00 dBm, Pilot channel, 1xEV-DO

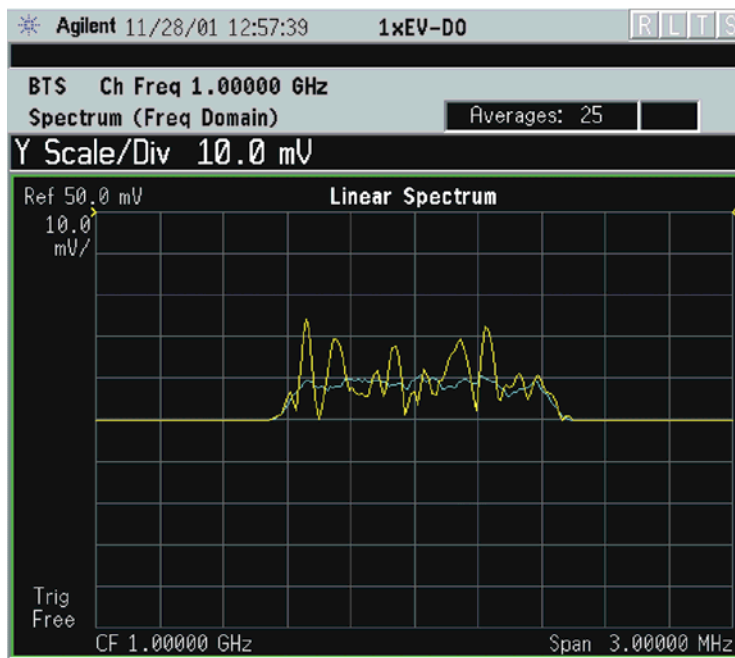
**Step 6.** Press the **View/Trace** key to display a menu allowing selection of another measurement result display including the following:

- **Spectrum** - Provides a combination view of the spectrum graph in parameters of power versus frequency with semi-log graticules, and the I/Q waveform graph in parameters of voltage and time. Changes to frequency span or power will sometimes affect data acquisition. This is equivalent to changing the selected window with the **Next** key.
- **Spectrum (Time Domain) I/Q Waveform** - (Key for PSA only) This graph is shown below the Spectrum graph in the default dual-window display. I/Q Waveform provides a view of the I/Q waveform in parameters of voltage versus time in linear scale. Changes to sweep time or resolution bandwidth can affect data acquisition.



- **Spectrum Linear** - (for E4406A) Provides a view of the spectrum graph in parameters of voltage versus frequency in linear scale. Changes to frequency span or voltage can affect data acquisition.

**Figure 2-48** Spectrum Measurement - Linear Spectrum View (for E4406A)



\*Meas Setup: View/Trace = Spectrum Linear,  
Span = 3.000 MHz,  
Y Scale/Div = 10.00 mV, Ref Value = 50.0 mV,  
Others = Factory default settings

\*Input signals: -10.00 dBm, Pilot channel, 1xEV-DO

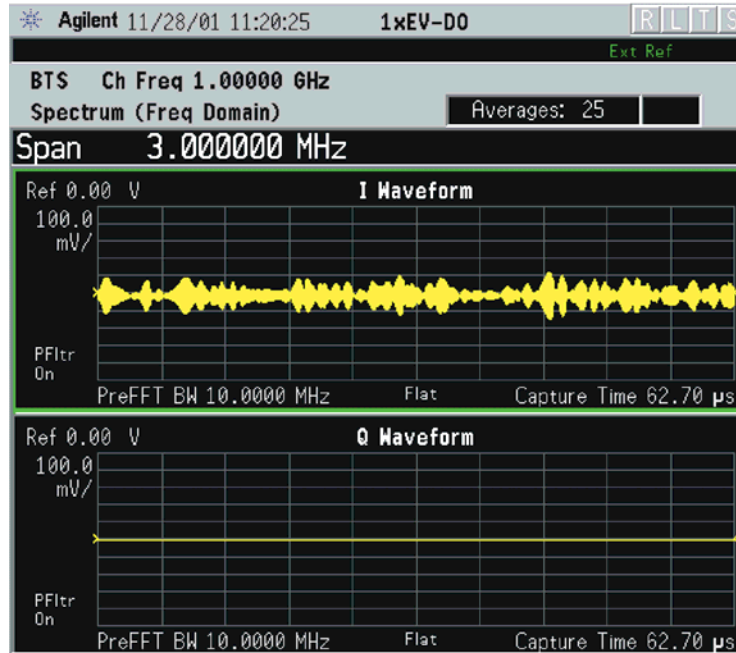
**NOTE**

(for E4406A) For the widest spans, the I/Q window becomes just “ADC time domain samples”, because the I/Q down-conversion is no longer in effect. This is not the case for E4406A Option B7C if the **Input Port** is set to either **I/Q**, **I only**, or **Q only** and you have connected baseband I/Q signals to the **I/Q INPUT** connectors.

- **I and Q Waveform** - (for E4406A) Provides individual views of the I and Q signal waveform windows in parameters of voltage versus time.

To select the I or Q trace view, press the **Next** key at the bottom of the display. The selected window will have a green outline. To view the window full size press the **Zoom** key.

**Figure 2-49** Spectrum Measurement - I and Q Waveform View (for E4406A)

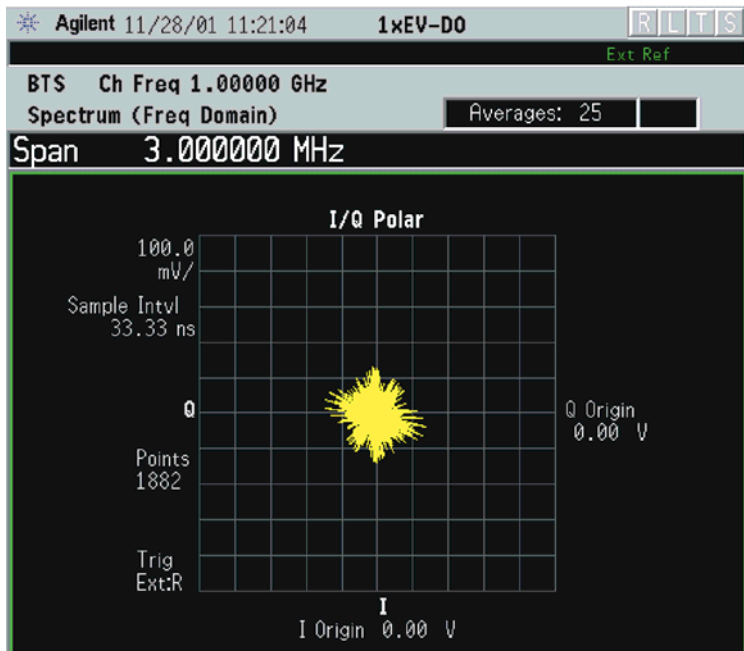


\*Meas Setup: View/Trace = I and Q Waveform,  
Others = Factory default settings

\*Input signals: -10.00 dBm, Pilot channel, 1xEV-DO

- **I/Q Polar** - (for E4406A) Provides a view of the I/Q signal displayed in a polar vector graph.

**Figure 2-50 Spectrum Measurement - I/Q Polar View (for E4406A)**



\*Meas Setup: View/Trace = I/Q Polar,  
Others = Factory default settings

\*Input signals: -10.00 dBm, Pilot channel, 1xEV-DO

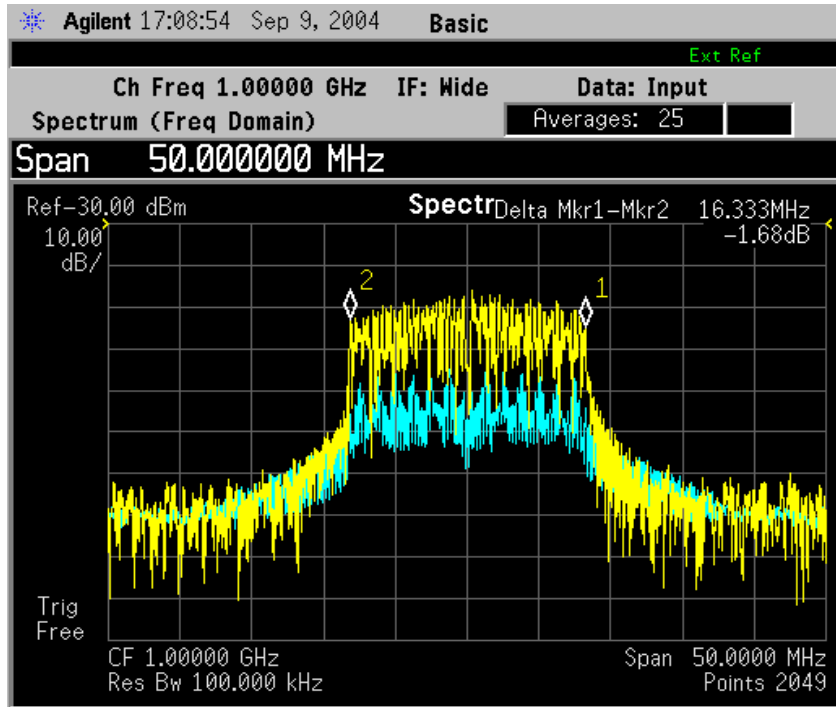
**Step 7.** To make a measurement repeatedly, press **Meas Control**, **Measure** to toggle the setting from **Single** to **Cont**.

**Step 8.** For PSA, if Option 122 or 140 is installed, you may use the wideband IF hardware to view a wide bandwidth signal in the Spectrum view. The I/Q Waveform view will be correctly demodulated to the I and Q components over the entire display bandwidth.

- Press **Mode**, and select **Basic** to be able to use the Wideband IF path.
- Press **Measure**, and select the **Spectrum** measurement.
- Press **SPAN** and toggle the **IF Path** key to select **Wide**. Adjust the span to view up to 80 MHz for Option 122, or up to 40 MHz for Option 140 around your selected center frequency. Note the example below has 1 million data points.

The example shown below is a 54 carrier OFDM signal which has a -10 dB bandwidth greater than 16 MHz, with skirts to over twice that bandwidth. Delta markers are shown measuring the peak bandwidth.

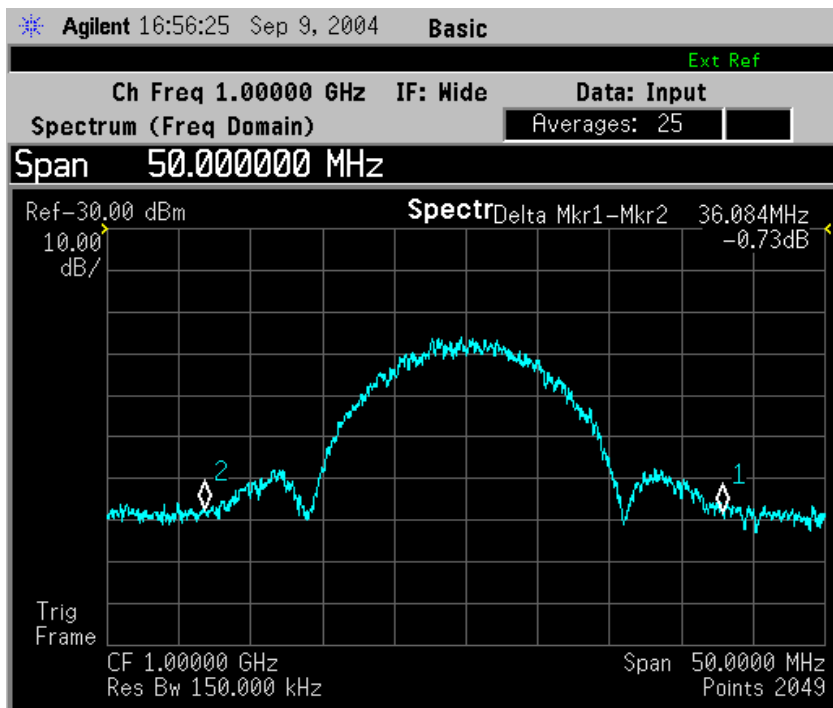
**Figure 2-51** Spectrum Measurement - Spectrum Zoom View with Opt. 122–80 MHz Bandwidth Digitizer Hardware



The example shown below is a 802.11 WLAN signal which has an instantaneous bandwidth of over 36 MHz. Only the Average trace is displayed.

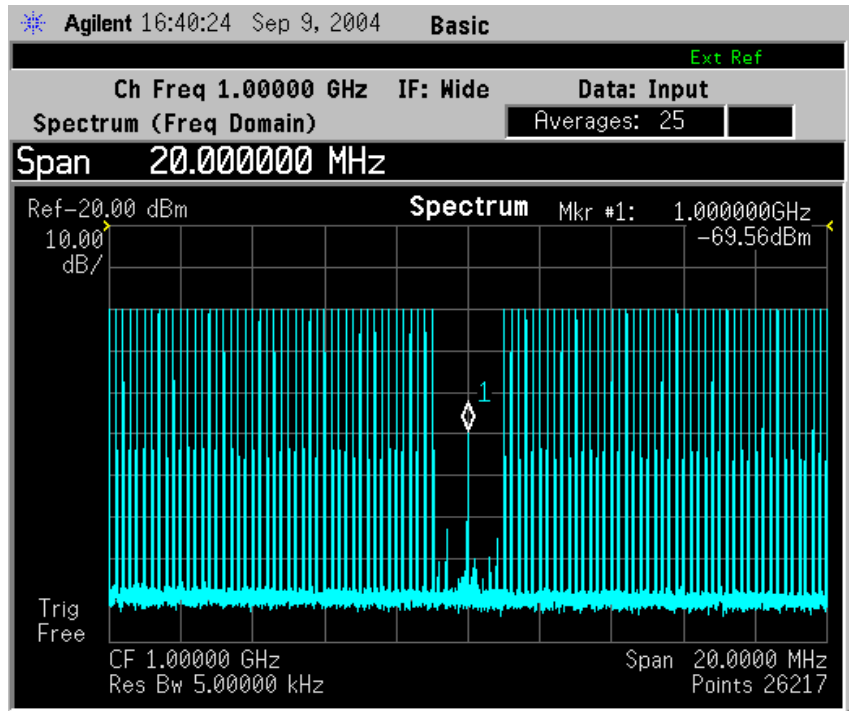
When using the widest spans, the Resolution Bandwidth may be limited by the maximum number of points available for a Spectrum measurement. If your desired setting exceeds the available number of points, the maximum number available will be used, and an error message will be displayed.

**Figure 2-52** Spectrum Measurement - Spectrum Zoom View with Opt. 122–80 MHz Bandwidth Digitizer Hardware



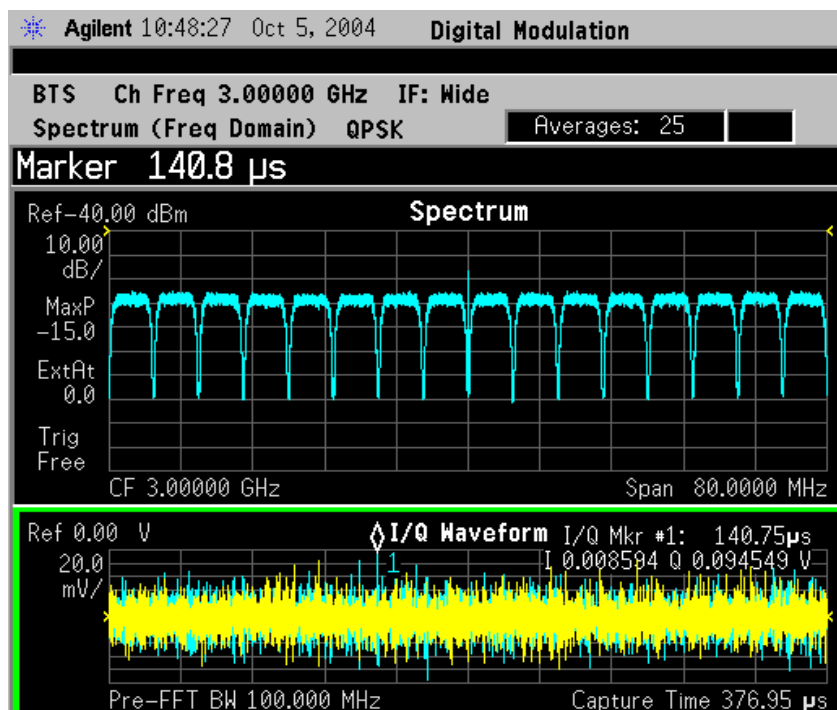
The example shown below is a Spectrum View of the center 20 MHz of a Noise Power Ratio measurement. If you extend the Span to the full 80 MHz bandwidth, individual carriers displayed may merge, as they can be limited by screen resolution and resolution bandwidth. Only the Average data trace is displayed in the example below.

**Figure 2-53** Spectrum Measurement - Spectrum View with Opt. 122– 80 MHz Bandwidth Digitizer Hardware



The wideband signal example shown below is 16 W-CDMA carriers, each occupying 5 MHz of bandwidth. The full 80 MHz of available demodulation bandwidth for the Spectrum measurement is used. Only the Average trace is displayed. Note the demodulated composite I/Q waveform for the entire 80 MHz BW signal in the **I/Q Waveform** window below. A peak search marker has been applied to the composite waveform.

**Figure 2-54** Spectrum Measurement - Spectrum Zoom View with Opt. 122–80 MHz Bandwidth Digitizer Hardware



**Step 9.** Press the **Meas Setup, More (1 of 2)** keys to check the keys available to change the measurement parameters from the default condition

For more details about using PSA Wide Bandwidth BW Digitizing Hardware Options 122 and 140, including detailed functional descriptions and SCPI commands and concepts, see the PSA Basic Mode Guide.

For more details about changing measurement parameters, see [“Spectrum \(Frequency Domain\) Measurement Concepts” on page 632](#)

If you have a problem, and get an error message, see [“Understanding Common Measurement Errors” on page 142](#).

## Spurious Emissions & ACP Measurements

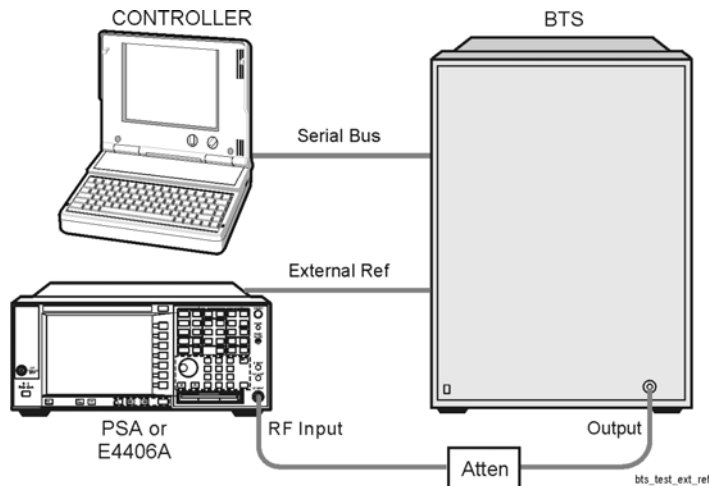
This section explains how to make a spurious emissions mask measurement (SEM) or adjacent channel power (ACP) measurement on a 1xEV-DO access network. ACP is a measurement of the amount of interference or power in an adjacent frequency channel. SEM compares the total power level within the defined carrier bandwidth and the given offset channels on both sides of the carrier frequency to levels allowed by the standard. Results of the measurement of each offset segment are viewable separately.

### Configuring the Measurement System

The access network (BTS) under test has to be set to transmit the RF power remotely through the system controller. The transmitting signal from the BTS is connected to the instrument's RF input port. Connect the equipment as shown below:

Figure 2-55

### Spurious Emissions & ACP Measurement System



1. Using the appropriate cables and attenuators, connect the output signal from the BTS to the RF input port of the instrument.
2. Connect the reference signal from the BTS to the EXT REF IN connector of the tester.
3. Connect the system controller to the BTS through the serial bus cable to control the BTS operation.



## Setting the BTS

From the system controller, perform all of the functions required for the BTS to transmit the RF signal.

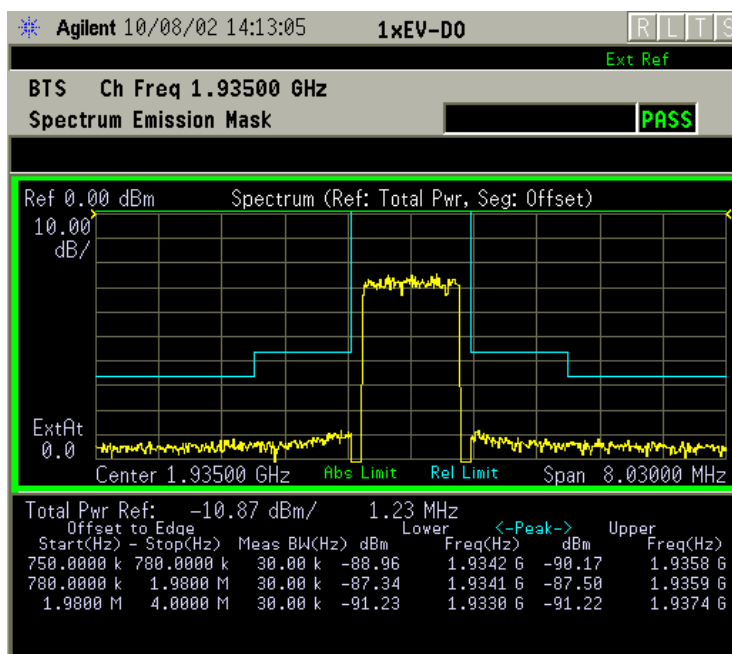
- **BTS**
  - Frequency      1,935.000 MHz (preferred channel number 100)  
(1,935.000 = (100 × 0.050) + 1930.000 MHz)
  - Output Power: Specified maximum output power level

## Measurement Procedure

- Step 1.** Press the **Preset** key to preset the instrument.
- Step 2.** Press the **MODE, More (1 of 2), 1xEV-DO** keys to enable the 1xEV-DO measurements.
- Step 3.** If your UUT is a MS, Press the **Mode Setup, Radio, Device** keys to toggle the selection to **MS**.
- Step 4.** Press the **Mode Setup, Input, Max Total Pwr** to enter the estimated maximum power from the BTS.
- Step 5.** Press the **Input Atten** and/or **Ext RF Atten** to enter the appropriate attenuation values depending on the estimated maximum power from the BTS.
- Step 6.** Press the **FREQUENCY Channel, 1935, MHz** keys to set the center frequency to 1,935.000 MHz.
- Step 7.** Press the **MEASURE, Spurious Emissions & ACP** keys to initiate the ACP or spurious emissions mask measurement. **Frame** under **Trig Source** needs to be selected for this measurement.

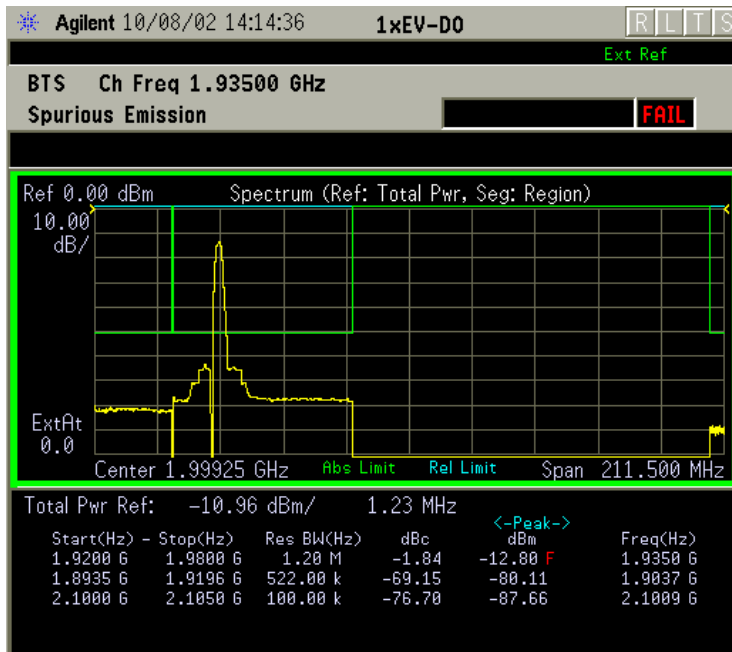
The Spectrum Emission Mask: Spectrum (Ref: Total Pwr, Seg: Offset) result should look like the next figure. The graph window and a text window are displayed. The text window shows the reference total power and the absolute peak power levels which correspond to the frequency bands on both sides of the reference channel.

**Figure 2-56** Spectrum Emission Mask Measurement Result - Offset (Default) View



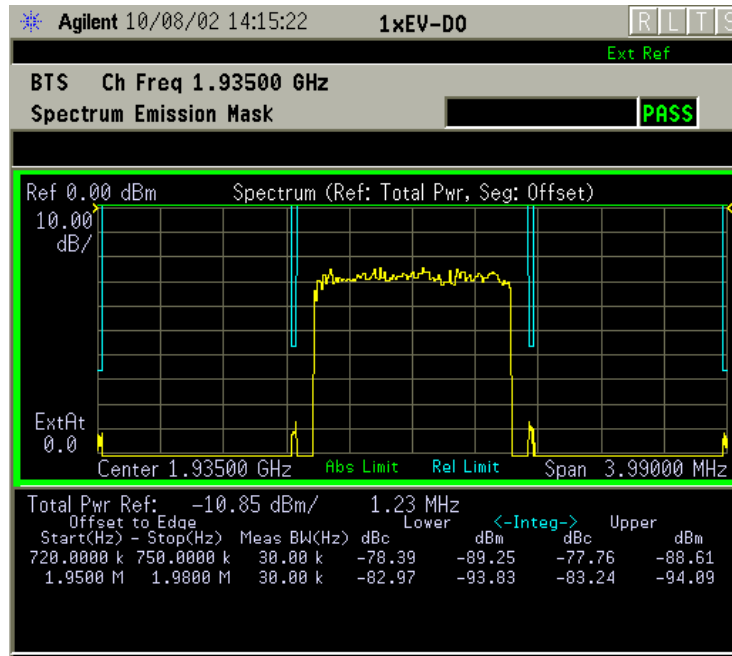
**Step 8.** Press the **Meas Setup**, **Spectrum Segment** keys to toggle to **Region**. The Spurious Emission: Spectrum (Ref: Total Pwr, Seg: Region) measurement result should look like the next figure.

**Figure 2-57** Spectrum Emission Mask Measurement Result - Region View



**Step 9.** Press the **Spectrum Segment** key back to **Offset**, and then press the **More (2 of 2)** and toggle the **Meas Mode** key to set to **ACP**.

**Figure 2-58** Spectrum Emission Mask Measurement Result - ACP View



**Step 10.** Press the **Meas Setup, More (1 of 2)** keys to check the keys available to change the measurement parameters from the default condition.

If you get an error message, see [“Understanding Common Measurement Errors”](#) on page 142.

## Troubleshooting Hints

ACP and spurious emissions measurements can reveal the presence of degraded or defective parts in the transmitter section of the UUT. The following are examples of problems which, once indicated by testing, may require further attention:

- Faulty DC power supply control of the transmitter power amplifier
- RF power controller of the pre-power amplifier stage
- I/Q control of the baseband stage
- Reduction in the gain and output power level of the amplifier due to a degraded gain control and/or increased distortion
- Degradation of amplifier linearity and other performance characteristics

Power amplifiers are one of the final stage elements of a base transmitter and play a critical part in meeting the important power and spectral efficiency specifications. Measuring the spectral response of

these amplifiers to complex wideband signals is crucial to linking amplifier linearity and other performance characteristics to the stringent system specifications.

## Waveform (Time Domain) Measurements

This section explains how to make waveform (time domain) measurement on a 1xEV-DO base station. Measurement of I and Q modulated waveforms in the time domain disclose the voltages which comprise the complex modulated waveform of a digital signal.

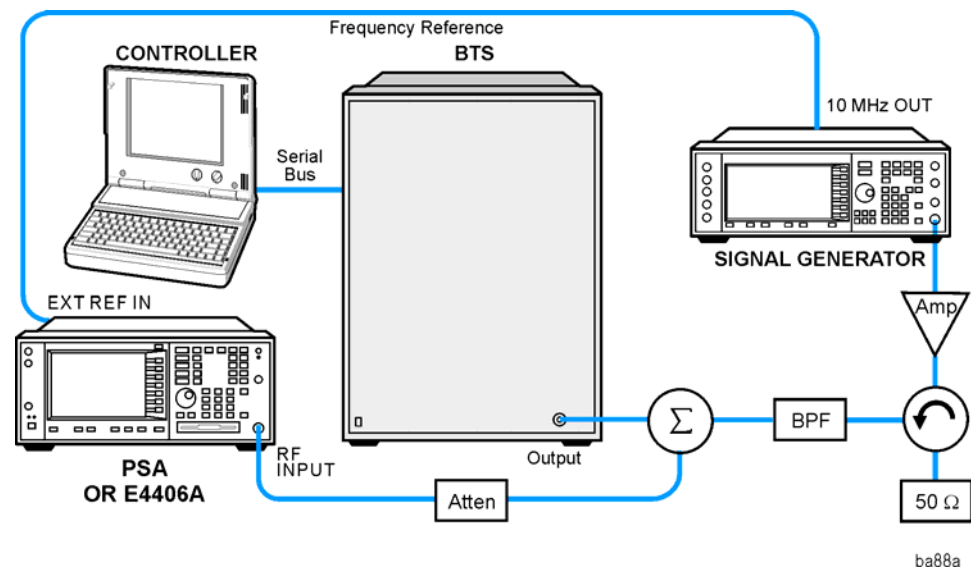
If installed, you may use PSA Option 122, the 80 MHz Bandwidth Digitizer hardware, or PSA Option 140, the 40 MHz Bandwidth Digitizer hardware to perform Waveform measurements of wideband signals using Basic Mode or PSA Option 241, Flexible Digital Modulation Analysis mode.

### Configuring the Measurement System

The base station (BTS) under test has to be set to transmit the RF power remotely through the system controller. This transmitting signal is connected to the instrument's RF input port. Connect the equipment as shown. An interfering or adjacent signal may be supplied as shown.

Figure 2-59

### Waveform Measurement System



1. Using the appropriate cables, adapters, and circulator, connect the output signal of the BTS to the RF input of the instrument.
2. Connect the base transmission station simulator or signal generator to the BTS through a circulator to initiate a link constructed with sync and pilot channels, if required.
3. Connect a BNC cable between the 10 MHz OUT port of the signal generator and the EXT REF IN port of the instrument.
4. Connect the system controller to the BTS through the serial bus

cable to control the BTS operation.

5. Connect an external trigger, if needed. Press **Mode Setup, Trigger** to access a menu to set up inputs and levels for all triggers. You must then select the appropriate trigger under the **Meas Setup, Trigger** menu to direct the measurement to use your trigger settings.

## Setting the BTS

From the system controller, perform all of the functions required for the BTS to transmit the RF signal.

- **BTS**  
Channel Configuration Pilot Only or MAC combined idle slot  
Frequency 1,935.000 MHz (preferred channel number 100)  
(1,935.000 = (100 × 0.050) + 1930.000 MHz)  
Output Power: Specified maximum output power level

## Measurement Procedure

- Step 1.** Press the **Preset** key to preset the instrument.
- Step 2.** Press the **MODE**, 1xEV-DO keys to enable the 1xEV-DO Mode measurements.
- Step 3.** To set the measurement center frequency press the **FREQUENCY Channel** key, enter a numerical frequency using the front-panel keypad, and complete the entry by selecting a units key, like **MHz**.
- Step 4.** Press the **SPAN** key, enter a numerical span using the front-panel keypad, and press the **MHz** key to set the measurement span in MHz.
- Step 5.** Press the **MEASURE** to initiate the Waveform measurement.

The default display shows both **Current** (yellow trace) and **Average** (blue trace) data. To make viewing the display easier, you can view either the **Current** trace or **Average** separately.

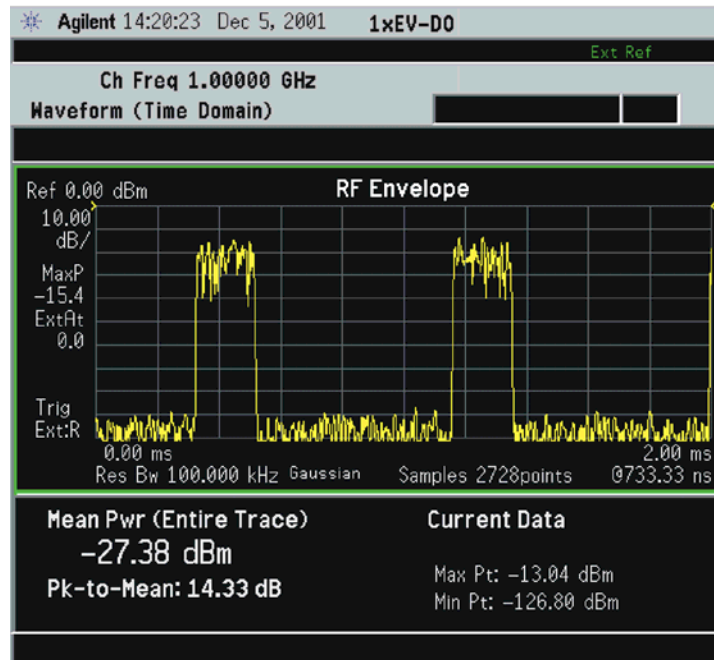
- Press **Trace/View, Trace Display**, and select the trace(s) desired for display.

**Step 6.** Press **SPAN X Scale**, and the up or down arrow keys until the waveform is shown at a convenient time scale for viewing.

The next figure shows an example of an **RF Envelope** (key is called **Signal Envelope** on VSA) result for a waveform (time domain) measurement. The measured values for the mean power and peak-to-mean power are shown in the text window.

**Figure 2-60**

**Waveform Measurement - RF Envelope (Default View)**



\*Meas Setup: View/Trace = RF Envelope,  
Trigger Source = Ext Rear,  
Others = Factory default settings

\*Input signal: -10 dBm, Idle slot, 1xEV-DO

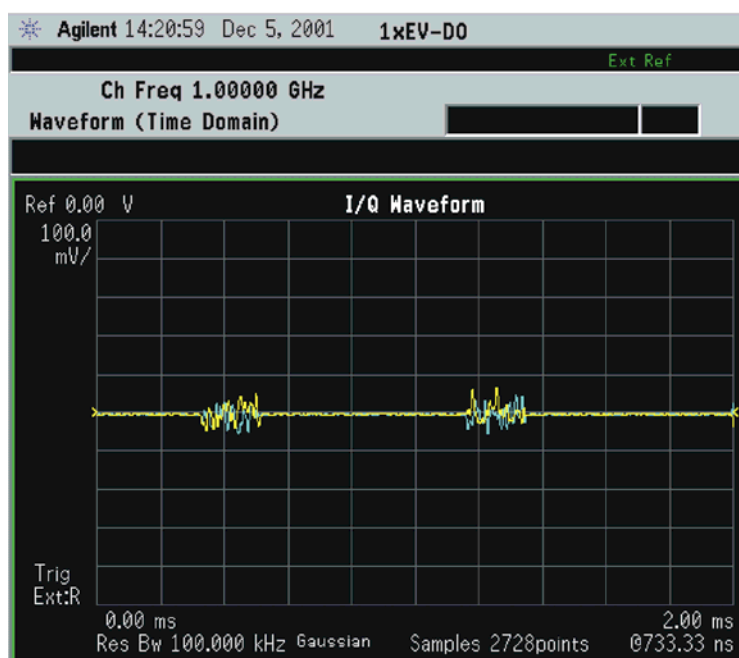
**Step 7.** Press the **Trace/View** (for PSA) or **View/Trace** (for E4406A) key to display the menu allowing selection of the other Waveform views, including the following:

- **I/Q Waveform** - Provides a view of the I and Q waveforms together on the same graph in parameters of voltage versus time in linear scale. Changes to sweep time or resolution bandwidth can affect data acquisition.

**NOTE**

For the widest spans the I/Q Waveform window becomes just “ADC time domain samples”, because the I/Q down-conversion is no longer in effect.

**Figure 2-61** Waveform Measurement - I/Q Waveform View



\*Meas Setup: View/Trace = I/Q Waveform,  
Trigger Source = Ext Rear,  
Others = Factory default settings

\*Input signal: -10 dBm, Idle slot, 1xEV-DO



- **I/Q Polar** - (for E4406A) Provides a view of the I/Q signal in a polar vector graph.

Figure 2-62

Waveform Measurement - I/Q Polar View



\*Meas Setup: View/Trace = I/Q Polar,  
Trigger Source = Ext Rear,  
Others = Factory default settings

\*Input signal: -10 dBm, Idle slot, 1xEV-DO

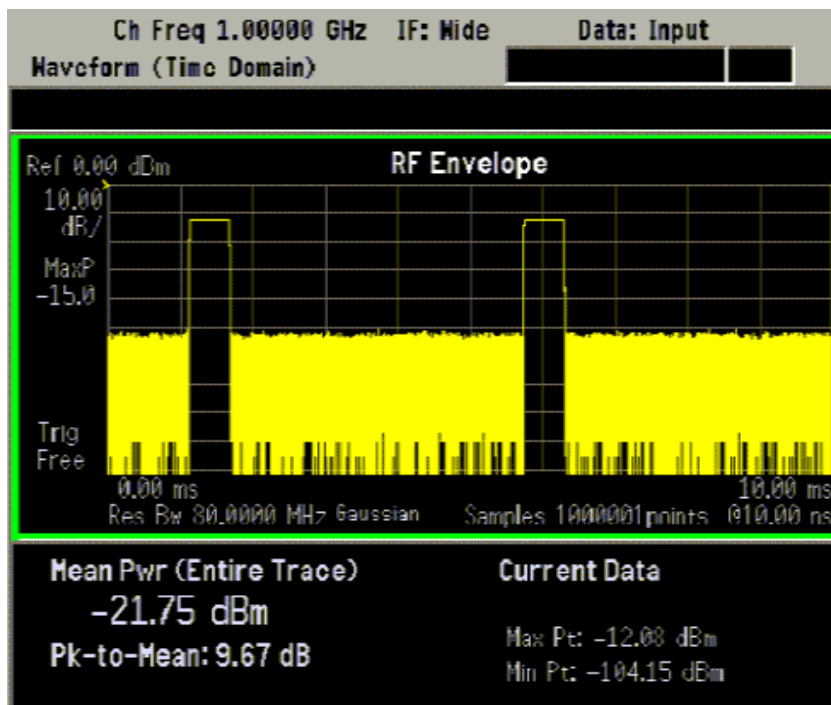
**Step 8.** If PSA Option 140 or 122 is installed, you may use the 40 or 80 MHz Bandwidth hardware to view a wideband signal in the Waveform view. Even if you are not interested in a wideband signal, using the Wideband IF path provides powerful measurement flexibility, including to the ability to accurately set practically any sample rate and thereby resample waveforms. Resampling, or oversampling, at the correct rate allows you to effectively obtain an integer number of samples per symbol. Make sure that the sample time is aligned with the decision points of the symbols to make analysis of measurement data much easier.

The following example of performing a Wideband IF Waveform measurement of a GSM burst will show the technique to accurately align and resample a signal:

- Press **Mode**, and select **Basic** to be able to use the 80 MHz IF path.
- Press **Measure**, and select the **Waveform** measurement.
- Press **Trace/View** and select the **RF Envelope** view.

- Press **SPAN** and toggle the **IF Path** key to select **Wide**. Adjust the span to view up to 80 MHz around your selected center frequency. Note the example below has 1 million data points.

**Figure 2-63** Waveform Measurement - RF Envelope View with Opt. 122– 80 MHz Bandwidth Digitizer Hardware



- Make sure that your samples are synchronized to the decision points of the signal of interest. In this case we will use the internal Frame Timer to trigger our measurement. A GSM frame is 4.615383 ms long.

Press **Mode Setup, Trigger**, select **Frame Timer**, then select **Period**. Enter 4.615383 ms. This only sets the frame timer period. You must direct the measurement to use the Frame Timer in the next step:

Press **Meas Setup, Trigger Source** and select **Frame**.

For other measurements, an external trigger may be applied to an External Trigger Input, on either the front or the rear panels. You must specify that trigger selection in this menu.

- In this example, we want to capture an entire GSM burst of 144 symbols (plus guard). A GSM burst is approximately 4.6 ms, so we will set our **Meas Time** to 5 ms:

Press **Meas Setup, Meas Time** and enter 5 ms.

- In this resampling example, we want to take exactly 10 samples per GSM symbol. The GSM symbol rate is 270.833 kHz, so we want a sample rate of 2.70833 MHz. Option 122 Wideband IF hardware lets us set the desired sample rate, as follows: sample rate = 5/4 IF Bandwidth. That means we need set an IF BW of 2.16667 MHz.

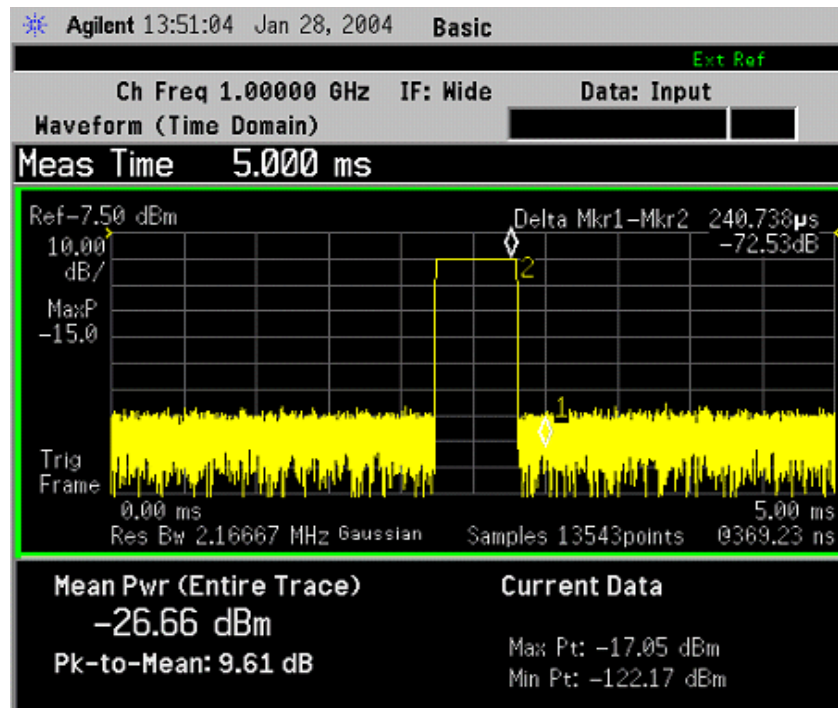
Press **Meas Setup**, **IF BW** and enter 2.16667 MHz.

You can also access the sample rate key directly:

Press **Meas Setup**, **Wideband Setup**, and **Sample Rate** keys. Enter the **Sample Rate** frequency. The **Sample Rate** and **IF BW** settings are coupled. The 5/4 ratio will be preserved regardless of which setting is used.

- Your measurement result should look like Appendix Figure 2-64, “Waveform Measurement - RF Envelope View with Opt. 122- 80 MHz Bandwidth Digitizer Hardware,” on page 139

**Figure 2-64** Waveform Measurement - RF Envelope View with Opt. 122–80 MHz Bandwidth Digitizer Hardware



For more details about making wideband measurements, see the Option 122 section in the Basic Mode Guide.

- Step 9.** Press the **AMPLITUDE Y Scale**, and down arrow keys until the waveforms are shown at a convenient voltage scale for viewing.
- Step 10.** Press the **SPAN X Scale**, and down arrow keys until the waveforms are shown at a convenient time scale for viewing.

- Step 11.** Press the **Marker**, **Trace**, and **I/Q Waveform** keys to activate a marker. Rotate the RPG knob until the marker is shown at a desired time in the waveform for viewing the trace values at the time position of the marker.
- Step 12.** To make a measurement repeatedly, press **Meas Control**, **Measure** to toggle the setting from **Single** to **Cont**.
- Step 13.** Press the **Meas Setup**, **More (1 of 2)** keys to check the keys available to change the measurement parameters from the default condition.

### Using the Waveform Measurement to Set Up Triggering (for burst signals)

You can use the waveform measurement to view your signal in the time domain and to help select the appropriate trigger to acquire your signal.

- Step 1.** Activate the waveform measurement view:  
Press **MEASURE**, **Waveform (Time Domain)**.
- Step 2.** Adjust the scale of the x-axis to view the complete signal waveform:  
Press **SPAN X Scale**, **Scale/Div**, then use the front-panel keypad to input the scale/div, then press a units key, like  $\mu\text{s}$ , to complete the entry.
- Step 3.** Select a trigger source (free run is the default setting):  
Press **Meas Setup**, **Trig Source**, then select one of the available trigger sources.
- Step 4.** Setup the trigger conditions:  
Press **Trig** or for E4406A press **Mode Setup**, **Trigger Setup**, then choose a trigger mode.

In the trigger mode set the delay, peak level and positive or negative edge slope trigger. You can also setup trigger holdoff, auto trigger timing and frame timer settings. For more information on trigger settings see [“Trigger Key Menu” on page 154](#).

For more details about using PSA Option 122, 80 MHz BW Digitizing Hardware, and PSA Option 140, 40 MHz Digitizing Hardware, including detailed function descriptions, SCPI commands and concepts, see the PSA Basic Mode Guide.

For more details about changing measurement parameters, see [“Waveform \(Time Domain\) Measurement Concepts” on page 633](#)

If you have a problem, and get an error message, see [“Understanding Common Measurement Errors” on page 142](#).

## Using Basic Mode

Basic mode is a standard feature of E4406A Transmitter Testers, and is part of Option B7J for the PSA Series Spectrum Analyzers. Basic mode is *not* related to a particular communications standard. That is, it does not default to measurement settings that are for any specific standard. You may want to use Basic Mode if you are making measurements on a signal that is not based on a specific digital communications standard.

### Basic Mode in E4406A VSA Series Transmitter Testers

There are five generic measurements available under the **MEASURE** key in Basic mode:

- Adjacent Channel Power (ACP)
- Channel Power
- Power Statistics CCDF
- Spectrum measurement (frequency domain).
- Waveform measurement (time domain)

The ACP, Channel Power, and Power Stat CCDF measurements are fully described in the VSA Series User's Guide. Please refer to that manual for complete information on these measurements.

### Spectrum and Waveform Measurements

These measurements provide a spectrum measurement mode that is similar to a standard spectrum analyzer, and a waveform measurement mode that is similar to a microwave oscilloscope. Unlike those standard analyzers, these measurements are optimized for digitally modulated signals, so they can be used to output the measured I/Q data.

For your convenience, Spectrum and Waveform measurements are also available in this mode, with the same functionality, so you can refer to the sections included in this chapter for information about using them.

### Basic Mode in PSA Series Spectrum Analyzers

There are two generic measurements available under the **MEASURE** key in Basic mode:

- Spectrum measurement (frequency domain).
- Waveform measurement (time domain)

These Spectrum and Waveform measurements are also available in this mode, with the same functionality, so you can refer to the sections included in this chapter for information about using them.

---

## Understanding Common Measurement Errors

During the execution of your measurement you may encounter problems which generate error codes. Reference to the following common errors may be helpful.

If **Err** is shown in the annunciator bar, press the **System, Show Errors** hard and soft keys to read the detailed error information.

- **Measurement Instability- Low Input Signal Level**

If the input signal level is too low to make a valid measurement no code domain power will be displayed in the **Power** graph window. In this situation, no error message can be displayed to indicate the nature of the fault. If you cannot increase the power into the tester, you need to increase the input sensitivity by adjusting the ADC range.

Press **Meas Setup, More (1 of 3), More (2 of 3), Advanced, ADC Range,** and then **Manual** keys. Increase the setting from the  $-6$  dB (for E4406A) or None (for PSA) default to 6 dB, for example. Another option is to use the **Auto** setting (the **Auto** setting is not used as the default to improve measurement speed).

Press **Restart** to make another measurement and observe the results. Re-adjust the ADC as necessary to obtain a valid measurement.

- **Error Code 16 “Input overload”**

This error means that your measurement has erroneous results due to the excessive input power level. To correct this condition, the input signal level must be reduced by using the internal and/or external attenuators.

Press the **Mode Setup, Input, Input Atten** keys to enter an attenuation value to reduce the transmitted power from the MS. This allowable range is up to 40 dB.

If you want to attenuate more than 40 dB, connect your external attenuator between the **RF INPUT** port and the DUT. Be sure to add its attenuation value to the readings of the measurement result.

To automate this calculation, press the **Mode Setup, Input, Ext Atten** keys to enter the additional attenuation value. The allowable range is up to 100 dB. The power readings of the measurement will take into account the external attenuation value.

- **Error Code 601 “Signal too noisy”**

This error means that your input signal is too noisy to capture the correct I/Q components. To make a more stable measurement the trigger source may need to be set to **Frame**, for example.

- **Error Code 604 “Can not correlate to input signal”**

This error means that the tester has failed to find any active channels in the input signal as specified. To improve the correlation some critical parameter needs to be adjusted, like the input signal level or scramble code, for example.

For more details consult the chapter in this book dedicated to the measurement in question, or see the “Instrument Messages and Functional Tests” manual.

Making Measurements  
**Understanding Common Measurement Errors**



---

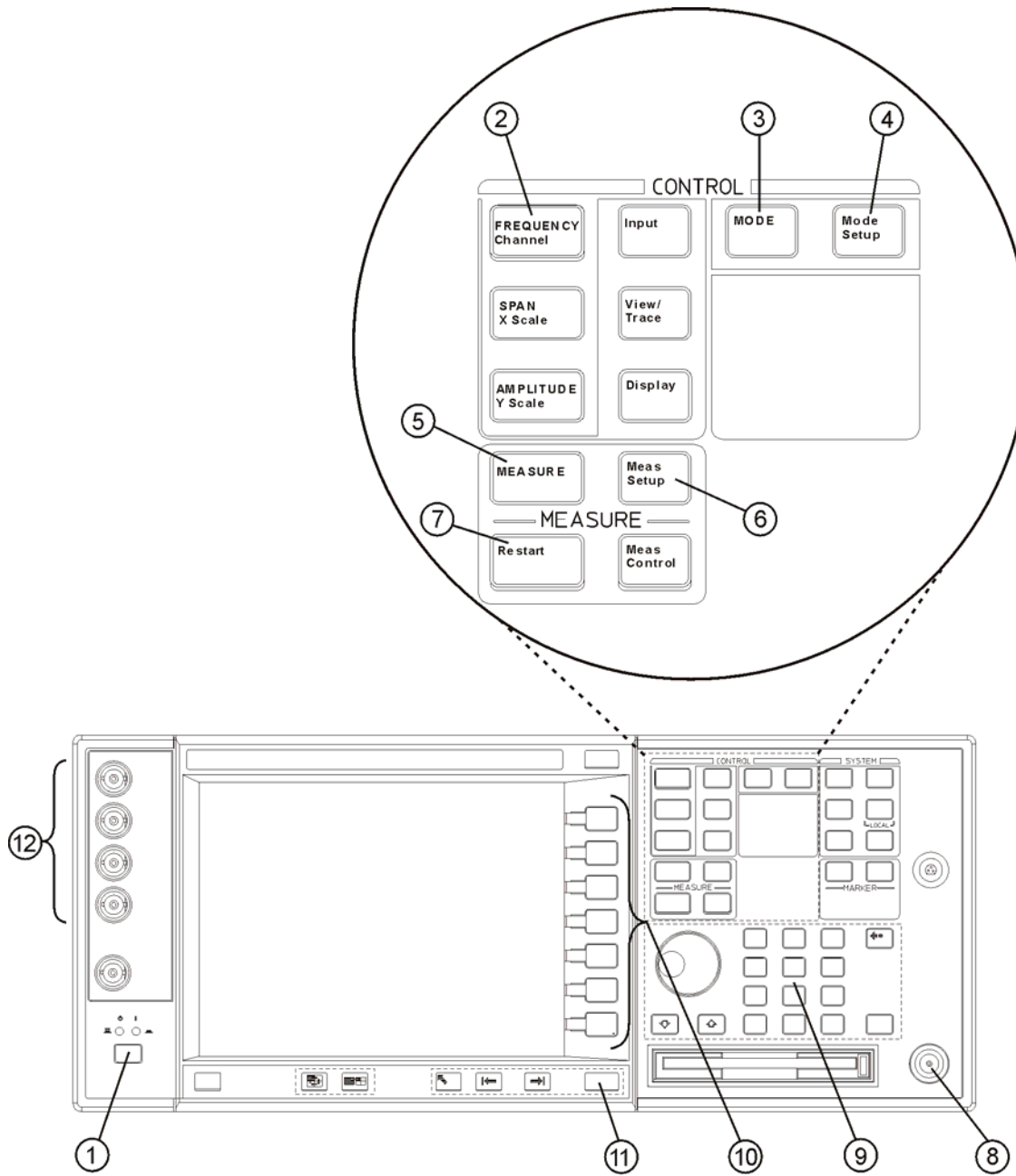
## 3 Key Reference

This chapter provides detailed descriptions of the keys used to set up and make 1xEV-DO measurements, including **Mode Setup**, **Meas Setup**, and **MEASURE**. Keys that allow you to see different presentations of the measurement results are also described, including **View/Trace**, and **Display**, showing the associated screens.

## Instrument Front Panel Highlights

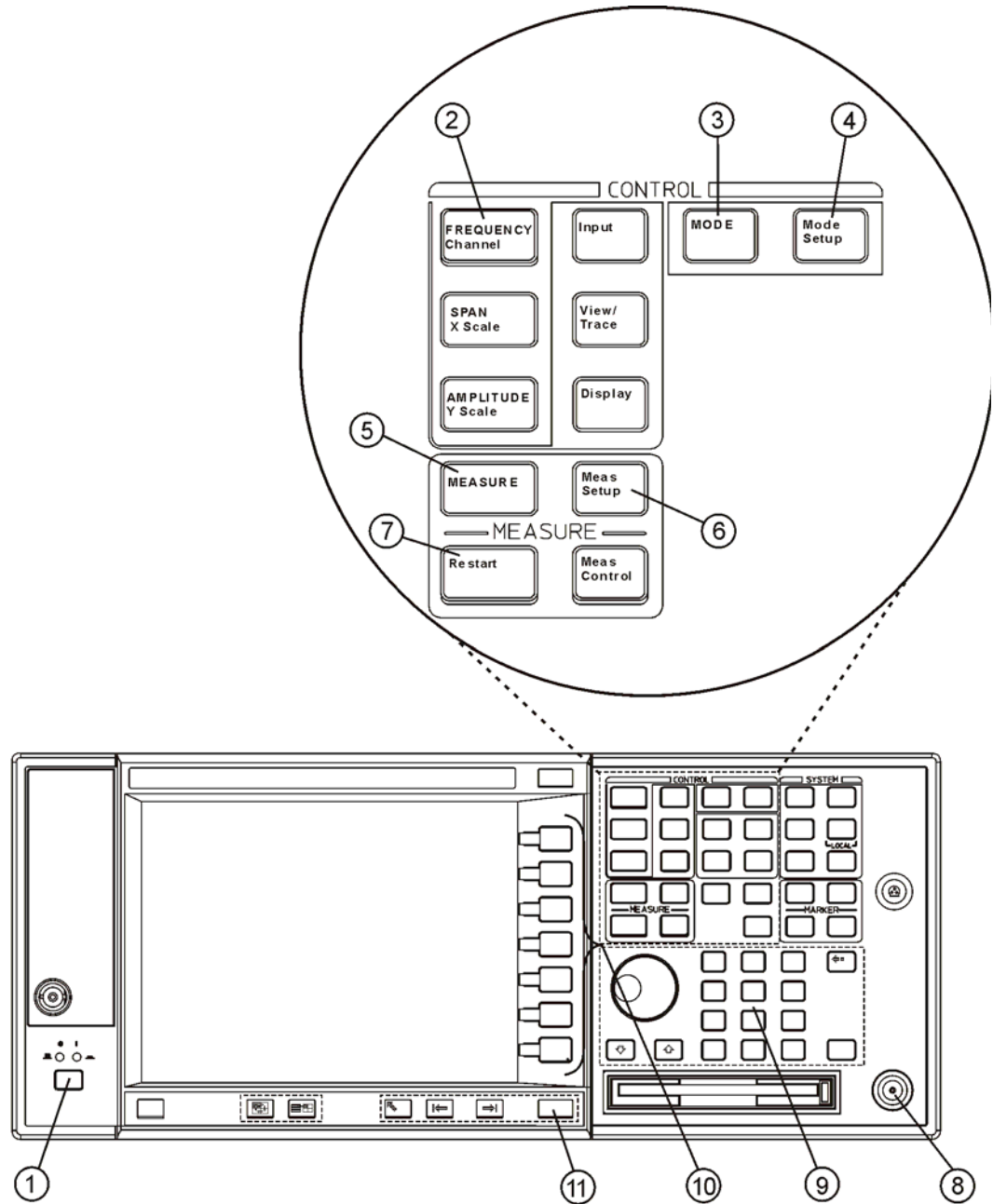
The major functional keys on the front panel are located as illustrated below, and each of these operation is explained on the next page.

**Figure 3-1** Front Panel Major Key Locations VSA E4406A



aa81a

Figure 3-2 Front Panel Major Key Locations - PSA Series



ar84a

Key Reference  
Instrument Front Panel Highlights

1. The **On/Off** switch toggles the power between on and off. A green LED will be on once the instrument has been turned on. When in the standby mode a yellow LED is on above the **On/Off** switch.
2. **FREQUENCY Channel** accesses the softkey that controls the center frequency or channel number. These parameters apply to all measurements in the current mode.
3. **MODE** accesses the softkey menu to select one of the radio systems measurement modes loaded in the instrument. Each mode is independent from all other modes.
4. **Mode Setup** accesses softkeys that affect parameters that are specific to the current mode and affect all measurements within that mode.
5. **MEASURE** accesses the menus to initiate one of the various measurements that are specific to the current mode.
6. **Meas Setup** accesses the menus of test parameters that are specific to the current measurement.
7. **Restart** causes the measurement, for which the process is currently halted, to start again from the beginning of the measurement according to the current measurement setup parameters.
8. The **RF INPUT** port allows you to apply an external RF signal.
9. The **Data Entry** keypad is used to enter numeric values for parameters. A value from this entry will be displayed in the active function area of the screen. The value will become valid after pressing the **Enter** key, or selecting a unit of measurement, depending on the current parameter.
10. The **Softkeys** allow you either to activate a feature or to access a further softkey menu. An arrow on the right side of a softkey label indicates that the key has a further selection menu. The active softkey is highlighted. Grayed-out keys are currently unavailable for use or are only to show information. If a softkey menu has multiple pages, access them by pressing the **More** key at the bottom of a menu.
11. **Return** allows you to exit from the current menu and display the previous menu. If you are on the first page of a multiple-page menu (the menu with **More (1 of 3)** for example), the **Return** key will exit from that menu. When you activate a different measurement, the return list is cleared. The **Return** key will not return you to a previously activated mode, nor will it alter any values you have entered on previous menus.
12. Option B7C Baseband I/Q Inputs (E4406A only) allow you to analyze signals using selected digital modulation formats at baseband frequencies. See the section on using Option B7C in the next chapter.

## Front Panel Keys

### NOTE

Only front panel keys affected by selection of 1xEV-DO mode are described here. For a complete description of all front panel keys see the E4406A VSA or PSA Series User's Guide.

## FREQUENCY Channel Key Menu

Key Path: **FREQUENCY Channel**

- **Center Freq** - Allows you to enter a frequency that corresponds to the desired RF channel to be measured. This is the current instrument center frequency. The range is 1.000 kHz to 4.32140 GHz with 1 Hz resolution.
- **CF Step** - Allows you to enter a center frequency step to shift the measurement segment, and to toggle the step function between **Auto** and **Man**. When set to **Auto**, the **CF Step** value automatically changes according to the selection of the standard. The range is 1.000 kHz to 1.00000 GHz with 1 Hz resolution.

Frequency Channel Default Settings	
FREQUENCY Channel:	
Center Freq	1.00000 GHz
CF Step	1.25000 MHz, Auto

## MEASURE Key Menu

Key Path: **MEASURE**

- **Channel Power** - Press this key to make channel power measurements for BTS (Fwd) and MS (Rev) tests. This is the in-channel power measurement. The channel power graph is displayed in the graph window and both the absolute channel power and mean power spectral density are shown in the text window.
- **Intermod** - Press this key to make intermodulation products measurements for BTS (Fwd) tests. Three measurement modes are available as follows:
  - Auto - Automatically identifies one of two modes between two-tone or transmit intermodulation products.
  - Two-tone - Measurements are made assuming two signals present in the span are the two tone signals.
  - Transmit IM - Measurements are made assuming the lower frequency signal to be the modulated transmitted signal and the

higher frequency signal to be the tone signal.

- **Power vs Time** - Press this key to make power versus time measurements for BTS (Fwd) tests. This is the time-captured burst power measurement. The time offsets and power mask levels up to 5 pairs are defaulted for quick applications according to the radio standard, however, these are also user-definable for specific measurement requirements. Choices of display portions for those burst signals include the whole burst waveform, rising and falling edge waveforms, rising edge waveform, and so forth.
- **Spurious Emissions & ACP** - Press this key to make adjacent channel power (ACP) measurements or spurious emissions measurements with frequency offsets and mask limits up to 5 pairs, for BTS (Fwd) tests. The **Meas Mode** key toggles the measurement function mode between **SEM** and **ACP**. The measurement mask is configurable with flat and sloped lines according to the radio system specifications. Spurious emissions measurements can be done with some restrictions from the upper frequency bandwidth by setting the measurement regions with **SEM** in **Meas Mode**.
- **Occupied BW** - Press this key to make occupied bandwidth measurements for BTS (Fwd) and MS (Rev) tests. The frequency bandwidth that contains 100.0% of the total power is measured first, and then 99.0% of the frequency bandwidth is calculated as the measurement result.
- **Code Domain** - Press this key to make code domain power (CDP) measurements. The amount of power in each code channel is displayed.

For BTS tests by setting **Device** to **BTS (Fwd)**, the following windows are available:

- Power graph and metrics to show the I and Q code domain power versus Walsh code and the summary data
- I/Q polar and power graphs to show the code domain power, I/Q symbol polar vector for the specified Walsh code, and its chip power

For MS tests by setting **Device** to **MS (Rev)**, the following windows are available:

- Power graph and metrics to show the code domain power versus Walsh code and the summary data
- A dual-display with a Code Domain Power graph showing I and Q power versus Walsh code with symbol power for each active channel, and a Code Domain Error Graph showing error in dB by Walsh code channel.
- I/Q error quad view with the magnitude error versus symbols, phase error versus symbols, and error vector magnitude versus

symbols graphs, and the summary data in the text window

- Demodulated bits to show the I and Q power graph versus Walsh code, symbol power for the specified Walsh code, and the demodulated bits stream of the specified symbol power
- **Mod Accuracy (Composite Rho)** - Press this key to make modulation accuracy (composite rho) measurements. The input signal should contain the Pilot channel. This is essentially a code domain power measurement with more than one active channel.

For BTS tests by setting **Device** to **BTS (Fwd)**, the following windows are available:

- Polar graph of the I/Q demodulated signals and the summary data
- Result metrics table for the measured channels, rho, EVM, errors for magnitude, phase, and frequency, the I/Q origin offset, pilot offset, and the number of active channels for pilot, MAC, and data
- I/Q error quad view with the magnitude error versus chips, phase error versus chips, and error vector magnitude versus chips graphs, and the summary data in the text window
- I/Q measured quad view with inclusion of the I and Q power versus chips, I/Q vector absolute power versus chips, and I/Q measured polar graphs with a text window for the mean power level
- Power, timing, and phase table to list the measurement results for Code, Power (dB), Timing (ns), and Phase (rad).

For MS tests by setting **Device** to **MS (Rev)**, the following windows are available:

- Polar graph of the I/Q demodulated signals and the summary data
- Peak/Avg. Metrics table for the measured channels, rho, EVM, errors for magnitude, phase, and frequency, the I/Q origin offset, pilot offset, and the code domain power levels of active channels for pilot, RRI, ACK, DRC, and data
- I/Q error quad view with the magnitude error versus chips, phase error versus chips, and error vector magnitude versus chips graphs, and the summary data in the text window
- Code Domain Power graph, showing code domain power for active channels by Walsh code number, and summary results in the text window.
- **QPSK EVM** - Press this key to make QPSK error vector magnitude (EVM) measurements for BTS (Fwd) tests. The following windows are available:

## Key Reference

### Front Panel Keys

- Polar vector graph of the I/Q demodulated signals and the summary data
- Polar constellation graph of the I/Q demodulated signals and the summary data
- I/Q error quad view with the magnitude error versus chips, phase error versus chips, and EVM versus chips graphs, and the summary data
- **Power Stat CCDF** - Press this key to make power statistics, Complementary Cumulative Distribution Function (CCDF) measurements for BTS (Fwd) and MS (Rev) tests. This is helpful to observe the time domain characteristics of a spread spectrum signal that can significantly affect the ACPR measurement results for a given UUT.
- **Spectrum (Freq Domain)** - Press this key to make frequency domain spectrum measurements for BTS (Fwd) and MS (Rev) tests. The following windows are available:
  - Spectrum graph with the semi-log graticules and I/Q waveform graph with the linear graticules
  - Linear spectrum graph with the linear graticules (E4406A)
  - I and Q waveform graphs with the linear graticules (E4406A)
  - I/Q polar graph of the demodulated I/Q signals with the linear graticules (E4406A)
- **Waveform (Time Domain)** - Press this key to make time domain waveform measurements for BTS (Fwd) and MS (Rev) tests. The following windows are available:
  - RF signal envelope graph with semi-log graticules and summary data
  - I/Q waveform graph and summary data
  - I/Q polar graph of the demodulated I/Q signals with the linear graticules (E4406A)

## Meas Control Key Menu

Key Path: **Meas Control**

- **Restart** - Press this key to repeat the current measurement from the beginning, while retaining the current measurement settings. When pressed, the scale coupling function is activated for an appropriate display to the current input signal level. This is equivalent to the **Restart** front panel key.
- **Measure** - Press this key (not to be confused with the **MEASURE** front panel key which has a different function) to toggle the measurement



state between **Single** and **Cont** (continuous). When set to **Single**, the measurement will continue until it has reached the specified number of averages set by the average counter. When set to **Cont**, the measurement will run continuously and execute averaging according to the current average mode, either repeat or exponential. The default setting is **Cont** for most measurements, but the Code Domain and Power Stat CCDF measurements have **Single** as the default.

- **Pause** - Press this key to pause the current measurement until you reactivate the measurement. Once toggled, the label of the **Pause** key changes to read **Resume**. The **Resume** key, once pressed, continues the active measurement from the point at which it was paused.

## Mode Setup Key Menus

Key Path: **Mode Setup**

### Radio Key Menu

Key Path: **Mode Setup, Radio**

- **Device** - Allows you to access the menu to select a test station as follows:
  - **BTS (Fwd)** - Sets to make forward link tests or access network (base station transceiver system) tests. This is the default selection for all of the measurement functions.
  - **MS (Rev)** - Sets to make reverse link tests or access terminal (mobile station) tests. This will be always selectable, however, there can be some limitations of measurement selections as follows:

Depending on the selection of measurements, there will be the following differences in forward link tests and reverse link tests:

- ❑ *Dedicated to Forward Link* - The measurement functions for **Intermod, Power vs Time, Spurious Emissions & ACP, and QPSK EVM** are available when **Device** under **Radio** is set to **BTS (Fwd)**, otherwise these measurement keys are grayed out.
- ❑ *Common for Both Links* - The measurement functions for **Channel Power, Occupied BW, Power Stat CCDF, Spectrum (Freq Domain), and Waveform (Time Domain)** are available for both **BTS (Fwd)** and **MS (Rev)** selections under **Device**.
- ❑ *Unique to Forward Link or to Reverse Link* - The measurement functions for **Code Domain** and **Mod Accuracy (Composite Rho)** are designed uniquely to BTS tests or to MS tests. The measurement menus, measurement items, and screen pictures are different from each other depending on the selection of **BTS (Fwd)** or **MS (Rev)** under **Device**. For BTS tests, refer to “[Code Domain Keys \(Forward Link\)](#)” on page 163 and “[Modulation](#)”

[Accuracy \(Composite Rho\)\(forward link\) Keys](#)” on page 191.  
For MS tests, refer to [“Code Domain Keys \(Reverse Link\)”](#) on page 172 and [“Modulation Accuracy \(Composite Rho\) \(reverse link\) Keys”](#) on page 207.

### Input Key Menu

Key Path: **Mode Setup, Input**

---

**NOTE** You can also access the **Input** key from the **Input/Output** front panel key. For details on the **Input** key see [“Input/Output Key Menu”](#) on page 157.

---

### Trigger Key Menu

Key Path: **Mode Setup, Trigger, <trigger type>**

---

**NOTE** The actual trigger source is selected individually for each measurement under the **Meas Setup** key.

---

- **RF Burst, Video (Envlp), Ext Front, Ext Rear**- Pressing one of these trigger keys will access each triggering condition setup menu. This menu is used to specify the **Delay**, **Level** and **Slope** settings for each trigger source as follows:
  - **Delay** - Allows you to enter a numerical value to modify the trigger delay time. The range is  $-100.0$  to  $+500.0$  ms with  $1\ \mu\text{s}$  resolution. For trigger delay use a positive value, and for pre-trigger use a negative value.
  - **Level** - Allows you to enter a numerical value to adjust the trigger level depending on the trigger source selected.
    - ❑ For **RF Burst**, the key label reads as **Peak Level**. The RF level range is  $-25.00$  to  $0.00$  dB with  $0.01$  dB resolution, relative to the peak RF signal level. The realistic range can be down to  $-20$  dB.
    - ❑ For **Video (Envlp)**, the video level range is  $-200.00$  to  $+50.00$  dBm with  $0.01$  dB resolution at the RF input. The realistic range can be down to around  $-50$  dBm depending on the noise floor level of the input signal.
    - ❑ For **Ext Front** or **Ext Rear**, the level range is  $-5.00$  to  $+5.00$  V with  $1$  or  $10$  mV resolution.
  - **Slope** - Allows you to toggle the trigger slope between **Pos** at the positive-going edge and **Neg** at the negative-going edge of the burst signal.

There are other keys under the **Trigger** key as follows:

- **Trig Holdoff** - Allows you to set the period of time before the next trigger can occur. The range is  $0.000\ \mu\text{s}$  to  $500.0$  ms with  $1\ \mu\text{s}$

resolution.

- **Auto Trig** - Allows you to specify a time for a trigger timeout and toggle the auto trigger function between **On** and **Off**. The range is 1.000 ms to 1.000 ks with 1  $\mu$ s resolution. When no trigger occurs by the specified time, a trigger is automatically generated.
- **Frame Timer** - Allows you to access the menu to manually control the frame timer:
  - **Period** - Allows you to set the period of the frame clock. The range is 0.000 ns to 559.0000 ms with 1 ps resolution.
  - **Offset** - Allows you to set the offset of the frame clock. The range is 0.000 to 10.00 s with 100 ns resolution over 1.000  $\mu$ s range.
  - **Reset Offset Display** - Allows you to display without any offset of the frame clock.
  - **Sync Source** - Allows you to access the menu to select one of the sources to be synchronized with.
    - Off** - Allows you to turn the synchronizing source off for asynchronous tests.
    - RF Burst (Wideband)** (PSA Only)- Allows you to select the RF burst signal as the synchronizing source.
    - Ext Front** - Allows you to select the external input signal from the front panel input port as the synchronizing source.
    - Ext Rear** - Allows you to select the external input signal from the rear panel input port as the synchronizing source.

The trigger default settings are listed in the following table:

<b>Trigger Default Settings</b>	
RF Burst:	
Delay	0.000 $\mu$ s
Peak Level	-6.00 dB
Slope	Pos
Video (Envlp):	
Delay	0.000 $\mu$ s
Level	-6.00 dBm
Slope	Pos
Ext Front:	
Delay	0.000 $\mu$ s
Level	2.00 V
Slope	Pos

Trigger Default Settings	
Ext Rear:	
Delay	0.000 $\mu$ s
Level	2.00 V
Slope	Pos
Trig Holdoff	0.000 ms
Auto Trig	100.0 ms; Off
Frame Timer:	
Period	26.666667 ms
Offset	0.000 ms
Reset Offset Display	(effective unless Offset is 0.000 ms)
Sync Source	Off

### Demod Key Menu

Key Path: Mode Setup, Demod

- RF Carrier
  - **Single** - Sets the RF carrier to single, which allows you to measure **Code Domain, Mod Accuracy (Composite Rho)**, or **QPSK EVM** with a single carrier.
  - **Multi** - Sets the RF carrier to multiple, which allows you to measure **Code Domain, Mod Accuracy (Composite Rho)**, or **QPSK EVM** with multiple carriers.
- Physical Layer Subtype- Selects a set of presets and menus for **Code Domain** and **Mod Accuracy (Composite Rho)** measurements appropriate to 1xEV-DO signals constructed using Physical Layer Subtypes 0, 1, or 2, including **Predefined Active Channel** settings. Each channel (Pilot, DRC, RRI, ACK/DSC, Aux-Pilot or Data) can be set Active (On) or Inactive (Off). When **Active Code Channel** is set to **Auto**, each selection menu is grayed out. The specified active channel menus are different depending on whether subtype 0/1 or subtype 2 is selected:
  - **0/1** - Selects a set of presets appropriate to 1xEV-DO signals constructed using Physical Layer Subtypes 0 or 1 (Default).
  - **2** - Selects a set of presets appropriate to 1xEV-DO signals constructed using Physical Layer Subtype 2.

Demod Default Setting	
RF Carrier	Single
Physical Layer Subtype	0/1

## Input/Output Key Menu

Key Path: **Input/Output**

---

**NOTE**

---

You can also access the **Input** key from the **Mode Setup, Input** front panel key.

### Input Key Menu

Key Path: **Mode Setup, Input**

- **Input Port** - Allows you to access the menu to select one of the signal input ports as follows:
  - **RF** - Allows you to measure an RF signal supplied to the RF input port.
  - **50 MHz Ref** - Allows you to measure the internal 50 MHz reference signal to calibrate the instrument of VSA.
  - **Amptd Ref (f=50 MHz)** - Allows you to measure the internal 50 MHz reference signal to calibrate the instrument of PSA.
  - **IF Align** - Allows you to configure the IF alignment signal. The RF path is switched to bring in the same alignment signal that is automatically switched to perform many alignments.
- **RF Input Range** - Allows you to toggle the RF input range control between **Auto** and **Man** (manual). When **Auto** is chosen, the instrument automatically sets the attenuator based on the carrier power level, where it is tuned. Once you change the **Max Total Pwr** or **RF Input Atten** value with the RPG knob, for example, the **RF Input Range** key is automatically set to **Man**. When there are multiple carriers present, the total power might overdrive the front end. In this case you need to set the **RF Input Range** to **Man** and enter the expected maximum total power by activating the **Max Total Pwr** key. **Man** is also useful to hold the input attenuation constant for the best relative power accuracy. For single carriers it is generally recommended to set this to **Auto**.

When you use the internal preamplifier, **Int Preamp**, on PSA with Option 1DS, the selections using the **RF Input Range** key are not available, and the key is grayed out.

- **Max Total Pwr** - Allows you to set the maximum total power level from the UUT (Unit Under Test). The range is -200.00 to 100.00 dBm with 0.01 dB resolution. This is the expected maximum value of the mean carrier power referenced to the output of the UUT; it may include multiple carriers. The **Max Total Pwr** setting is coupled together with the **Input Atten** and **Ext Atten** settings. Once you change the **Max Total Pwr** value with the RPG knob, for example, the **Input Range** key is automatically set to **Man**.

Key Reference  
Front Panel Keys

When you use the internal preamplifier, **Int Preamp**, on PSA with Option 1DS, the selections using the **Max Total Pwr** key are not available, and the key is grayed out.

- **Input Atten** - Allows you to control the internal input attenuator setting. The range is 0 to 40 dB with 1 dB resolution. The **Input Atten** key reads out the actual hardware value that is used for the current measurement. When more than one input attenuator value is used in a single measurement, the value used at the carrier frequency will be displayed. The **Input Atten** setting is coupled to the **Max Total Pwr** setting. Once you change the **Input Atten** setting with the RPG knob, for example, the **Input Range** key is automatically set to **Man**.

When you use the internal preamplifier, **Int Preamp**, on PSA with Option 1DS, the electronic attenuator selections using the **Input Atten** key are not available, and the key is grayed out. Use the mechanical attenuator under **More 1 of 2, Attenuator**, below.

- **Ext RF Atten** - Allows you to access the following menu to enter the external attenuation values. Either of the **Ext RF Atten** settings is coupled together with the **RF Input Range** setting. However, pressing **Ext RF Atten** does not switch the **RF Input Range** key to **Man**. This will allow the instrument to display the measurement results referenced to the output of the UUT.
  - **MS** - Allows you to set an external attenuation value for MS tests. The range is -50.00 to +50.00 dB with 0.01 dB resolution.
  - **BTS** - Allows you to set an external attenuation value for BTS tests. The range is -50.00 to +50.00 dB with 0.01 dB resolution.
- **Int Preamp** - (for PSA with Option 1DS) Allows you to control the internal RF input preamplifier. The internal preamplifier provides +30 dB of gain and is useful for lower power measurements. The **Int Preamp** setting default is **Off**. RF power values displayed for these measurements are adjusted to compensate for the internal preamplifier gain, and indicate power levels at the input port. The preamplifier is only available for Modulation Accuracy (EVM and Peak Code Domain Error) measurements, QPSK EVM, and Code Domain measurements. When the **Int Preamp** is not available for a particular measurement, the key is grayed out.

To avoid damaging the internal preamplifier, limit the total power applied to the RF input to  $\leq +25$  dBm.

When using the internal preamplifier, the electronic attenuator selections using the **Input Atten** key are not available, and the key is grayed out. Use the mechanical attenuator under **More 1 of 2, Attenuator**, below.

- **Attenuator** - (for PSA with Option 1DS) When **Int Preamp** is set to **On**, this key allows you to control an internal mechanical input attenuator setting. The settings available are 0 dB, 10 dB, or 20 dB.

The **Attenuator** key shows the actual hardware value that is used for the current measurement. The **Attenuator** setting is not coupled to the **Max Total Pwr** setting.

The **Attenuator** is only available for measurements which can use the **Int Preamp**: Modulation Accuracy, QPSK EVM, and Code Domain measurements. When the **Int Preamp** is not available for a particular measurement, the key is grayed out.

**NOTE**

The **Max Total Pwr** and **Input Atten** settings are coupled together, so changing the input **Max Total Pwr** setting by x dB changes the **Input Atten** setting by x dB. When you switch to a different measurement, the **Max Total Pwr** setting is kept constant, but the **Input Atten** may change when the two measurements have different mixer margins. Therefore, you can set the input attenuator manually, or you can set it indirectly by specifying the expected maximum power from the UUT.

Input Default Settings	
Input Port	RF
RF Input Range	Auto <sup>a</sup>
Max Total Pwr	-15.00 dBm <sup>b</sup>
Input Atten	0.00 dB <sup>b</sup>
Ext RF Atten:	
MS	0.00 dB
BTS	0.00 dB
Int Preamp <sup>c</sup> (PSA Option 1DS)	OFF
Attenuator <sup>c</sup> (PSA Option 1DS)	0 dB

- a. Auto is not used for Spectrum (frequency domain) measurements.
- b. This may differ when the maximum input power is more than -15.00 dBm, or depending on the previous measurements.
- c. The internal preamplifier and attenuator are available for Modulation Accuracy (EVM and Peak Code Domain Error), QPSK EVM, and Code Domain measurements on PSA with Option 1DS.

---

## 1xEV-DO Measurement Keys

### Channel Power Keys

---

**NOTE** You must have selected Channel Power at Key Path: **MEASURE** to use these menus.

---

#### Measurement Setup Key Menu

Key Path: **Meas Setup**

- **Avg Number** - Allows you to change the number of N averages.
- **Avg Mode** - Allows you to toggle the averaging mode between **Exp** (exponential) and **Repeat**. This selection only effects on the averaging result after the number of N averages is reached. The N is set using the **Avg Number** key.
  - **Normal averaging:** Normal (linear) averaging is always used until the specified number of N averages is reached. When the **Measure** key under **Meas Control** is set to **Single**, data acquisition is stopped when the number of N averages is reached, thus **Avg Mode** has no effect in the single measurement mode.
  - **Exponential averaging:** When **Measure** is set to **Cont**, data acquisition will continue indefinitely. Exponential averaging is used with a weighting factor of N (the displayed count of averages stops at N). Exponential averaging weights new data more heavily than old data, which allows tracking of slow-changing signals. The weighting factor N is set using the Avg Number key.
  - **Repeat averaging:** When **Measure** is set to **Cont**, data acquisition will continue indefinitely. After the number of N averages is reached, all previous result data is cleared and the average count displayed is set back to 1. This is equivalent to being in **Measure Single** and pressing the **Restart** key each time the single measurement finishes.
- **Integ BW** - Allows you to specify the integration bandwidth in which the power is measured. The range is 1.000 kHz to 10.0000 MHz with 1 Hz resolution. Since **Integ BW** is coupled to **Chan Power Span** in the factory default condition, if you change the integration bandwidth setting, the channel power span setting changes by a proportional amount, 1.626 times the integration bandwidth, until a limit value is reached.
- **Chan Power Span** - Allows you to set the frequency span for the channel power measurement. The range is 1.000 kHz to 10.0000 MHz with 1 Hz resolution. This span is used for the current



integration bandwidth setting. Since **Chan Power Span** is coupled to **Integ BW** in the factory default condition, if you change the integration bandwidth setting, the channel power span setting changes by a proportional amount, 1.626 times the integration bandwidth, until a limit value is reached. However, the channel power span can be individually set.

- **Restore Meas Defaults** - Allows you to preset only the settings that are specific to the selected measurement by pressing **Meas Setup, More (1 of 2), Restore Meas Defaults**. This will set the measure setup parameters, for the currently selected measurement only, to the factory defaults.
- **Advanced** - Allows you to access the following menu to modify the channel power measurement parameters:

**NOTE**

Parameters under the **Advanced** key seldom need to be changed. Any changes from the factory default values may result in invalid measurement data.

- **Sweep Time** - Allows you to manually change the sweep time and also to toggle the sweep time control between **Auto** and **Man** (manual). The range is 1.0  $\mu$ s to 50.00 ms with 1  $\mu$ s resolution. If set to **Auto**, the sweep time derived from the data point setting is shown on this key regardless of the manual entry range.
- **Data Points** - Allows you to select the number of data points and also to toggle the data point control between **Auto** and **Man** (manual). The range is 64 to 65536 with the acceptable entry in powers of 2 (for example: 64, 128, 512). If set to **Auto**, the optimum number of points is determined for the fastest measurement time with acceptable repeatability. The minimum number of points that could be used is determined by the sweep time and the sampling rate. You can increase the length of the measured time record (capture more of the burst) by increasing the number of points, but the measurement will take longer.
- **Res BW** - Shows information on the resolution bandwidth derived from the sweep time. This key is always grayed out.
- **Trig Source** - Allows you to choose a trigger source from **Free Run (Immediate), Ext Front, Ext Rear, Frame,**

The next table shows the factory default settings for channel power measurements.

**Table 3-1**

**Channel Power Measurement Defaults**

Measurement Parameter	Factory Default Condition
Meas Setup: Avg Number	20; On

Table 3-1 Channel Power Measurement Defaults

Measurement Parameter	Factory Default Condition
Avg Mode	Repeat
Integ BW <sup>a</sup>	1.23000 MHz
Chan Power Span <sup>a</sup>	2.00000 MHz
<b>Advanced</b>	
Sweep Time	68.0 $\mu$ s; Auto
Data Points	512; Auto
Res BW (grayed out)	27.903 kHz (grayed out)
Trig Source	Free Run (Immediate)

a. The Integ BW setting proportionally changes the Chan Power Span setting up to 10 MHz.

## AMPLITUDE Y Scale Key Menu

Key Path: **AMPLITUDE Y Scale**

The **AMPLITUDE Y Scale** key accesses the menu to set the desired vertical scale and associated settings:

- **Scale/Div** - Allows you to enter a numeric value to change the vertical display sensitivity. The range is 0.10 to 20.00 dB with 0.01 dB resolution. The default setting is 10.00 dB. However, since the **Scale Coupling** default is **On**, this value is automatically determined by the measurement result. When you set a value manually, **Scale Coupling** automatically changes to **Off**.
- **Ref Value** - Allows you to set the absolute power reference value ranging from -250.00 to 250.00 dBm with 0.01 dB resolution. The default setting is 10.00 dBm. However, since the **Scale Coupling** default is **On**, this value is automatically determined by the measurement result. When you set a value manually, **Scale Coupling** automatically changes to **Off**.
- **Ref Position** - Allows you to set the display reference position to either **Top**, **Ctr** (center), or **Bot** (bottom). The default setting is **Top**.
- **Scale Coupling** - Allows you to toggle the scale coupling function between **On** and **Off**. The default setting is **On**. Upon pressing the **Restart** front-panel key or **Restart** softkey under the **Meas Control** menu, the scale coupling function automatically determines the scale per division and reference values based on the measurement results. When you set a value to either **Scale/Div** or **Ref Value** manually, **Scale Coupling** automatically changes to **Off**.

## Marker Key Menu

The Marker key is not available for this measurement function.

## Code Domain Keys (Forward Link)

---

**NOTE** This section describes making BTS tests, also known as forward link tests. When you are going to make MS tests or reverse link tests, see [“Code Domain Keys \(Reverse Link\)”](#) on page 172.

---



---

**NOTE** Select key path: **MEASURE, Code Domain** to access these menus.

---

## Meas Setup Key Menu

Key Path: **Code Domain, Meas Setup**

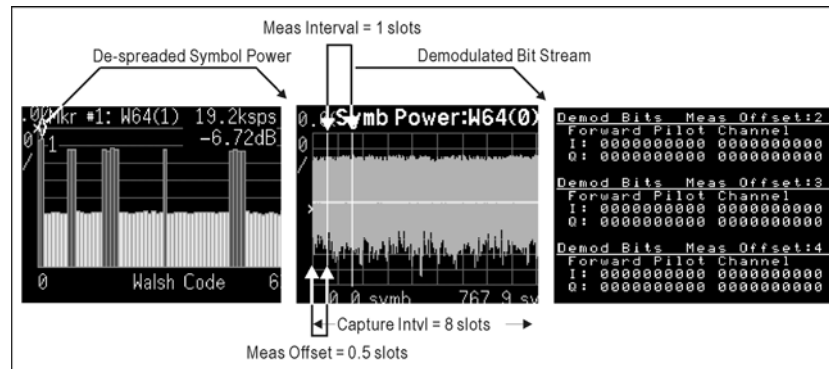
- **Meas Type** - Allows you to toggle the code domain power measurement type between **Rel** (relative) and **Abs** (absolute). When set to **Rel**, the measurement is made in the relative power in dBc.

## Key Reference

### 1xEV-DO Measurement Keys

When set to **Abs**, the measurement is made in the absolute power in dBm.

- **Walsh Code Number** - Allows you to set the Walsh code number. The range is 0 to 31 for Pilot channel, 0 to 63 for MAC channel, or 0 to 15 for Data channel.
- **Meas Interval** - Allows you to set the time interval in slots over which the chip power measurement is made. The range is 0.0 to **Capture Intvl** slots. The marker lines reflecting this value are displayed in the chip power graph of the **I/Q Polar & Power Graph** displays.
- **Meas Offset** - Allows you to set the number of offsets in slots to make a chip power measurement. The range is 0.0 to (**Capture Intvl** – 1) slots. The marker lines shift left or right by this value in the chip power graph of the **I/Q Polar & Power Graph** display. The following illustration shows the relationship between the capture interval and the measurement interval.



- **PN Offset** - Allows you to set the number of PN offsets in the unit of 64 chips to make a symbol power measurement. The range is 0 to 511. This value corresponds to the time offset between the trigger signal and the external frame signal.
- **Channel Type** - Allows you to access a menu to specify one of the following channel types:
  - **Pilot** - The channel type is set to pilot channel.
  - **MAC** - The channel type is set to medium access control (MAC) channel.
  - **Data** - The channel type is set to data channel. See **Data Ch Type**, below.
- **Data Ch Type** - Allows you to select one of the following data channel types when **Channel Type** is set to **Data**, otherwise this key is disabled:
  - **QPSK** - The data channel type is set to the quadrature phase shift keying.
  - **8PSK** - The data channel type is set to the eight phase shift

keying.

- **16QAM** - The data channel type is set to the sixteen quadrature amplitude modulation.
- **Preamble Len** - Allows you to specify the preamble length in number of chips from the first chip in the data channel, and to toggle the length detection mode between **Auto** and **Man** (manual). When set to **Auto**, the preamble length is automatically detected showing “---- chips” on this key. When set to **Man**, you can enter a value in number of chips to specify the preamble length that is excluded from the data calculation. The selections are 0, 64, 128, 256, 512, and 1024.
- **Active Data Chan** - Allows you to toggle the active channel ID detection between **Auto** and **Predef** (predefined). When set to **Auto**, the active channel ID detection is automatically made for the data channel measurement. When set to **Predef**, the predefined active channel detection is used for the data channel measurement.
- **Capture Intvl** - Allows you to set a value in number of slots for the measurement interval to make a chip power measurement. The range is 0.5 to 32.0 slots with 0.5 slot resolution, in conjunction with the **Meas Interval** value. The marker lines shift to the right or left by this value in the chip power graph of the **I/Q Polar & Power Graph** display.
- **Spectrum** - Allows you to toggle the spectrum function between **Normal** and **Invert**. This key, when set to **Invert**, conjugates the spectrum, which equivalently negates the quadrature component in demodulation. The correct setting (**Normal** or **Invert**) depends on whether the signal being input to the instrument has a high or low side mix.
- **Advanced** - Allows you to access the menu to set the following parameters.
  - **Active Set Th** - When **Active Code Chan** is set to **Auto**, this key allows you to toggle the active channel identification function between **Auto** and **Man**. When set to **Auto**, the active channels are determined automatically by the internal algorithm. When set to **Man**, the active channel identification for each code channel is determined by a user definable threshold ranging from -100.00 dB to 0.00 dB.
  - **Chip Rate** - Allows you to change the chip rate. The range is 1.10592 to 1.35168 MHz.
  - **Phase Compensation** - Allows you to turn the phase compensation function **On** or **Off**. When set to **On**, the measured phase will be compensated slot by slot referenced to pilot channel phase in one slot.
  - **ADC Range** - Allows you to access the following selection menu to

Key Reference  
1xEV-DO Measurement Keys

define one of the ADC ranging functions:

- ❑ **Auto** - Select this to automatically set the ADC range. For most FFT measurements, the auto feature should not be selected. An exception is when measuring a “bursty” signal, in which case **Auto** can maximize the time domain dynamic range, when FFT results are less important to you than time domain results.
- ❑ **Auto Peak** - Select this to set the ADC range automatically to the peak signal level. **Auto Peak** is a compromise that works well for both CW and burst signals.
- ❑ **Auto Peak Lock** - Select this to hold the ADC range automatically at the peak signal level. **Auto Peak Lock** is more stable than **Auto Peak** for CW signals, but should not be used for “bursty” signals.
- ❑ **Manual** - Allows you to access the selection menu of values, –6 through +24 dB for E4406A or None to +18 dB for PSA, to set the ADC range level. Also note that manual ranging is best for CW signals.

Table 3-2 shows the factory default settings for code domain power measurements.

Table 3-2

Code Domain Power Measurement Defaults

Measurement Parameter	Factory Default Condition
View/Trace	Power Graph & Metrics
Display: Code Order I/Q Combined Power Bar	Hadamard Off
Meas Setup: Meas Type	Rel (relative)

Table 3-2

Code Domain Power Measurement Defaults

Measurement Parameter	Factory Default Condition
Walsh Code Number	0
Meas Interval	1.0 slots
Meas Offset	0.0 slots
PN Offset	0 × 64 [chips]
Channel Type	Pilot
Data Ch Type	QPSK (when Channel Type is Data)
Preamble Len	---- chips; Auto
Active Data Chan	Auto
Capture Intvl	5 slots
Trig Source	Free Run (Immediate)
Spectrum	Normal
Meas Control: Measure	Single
<b>Advanced</b>	
Active Set Th	---- dB; Auto
Chip Rate	1.228800 MHz
Phase Compensation	Off
ADC Range: Manual	-6 dB (for E4406A), None (for PSA)

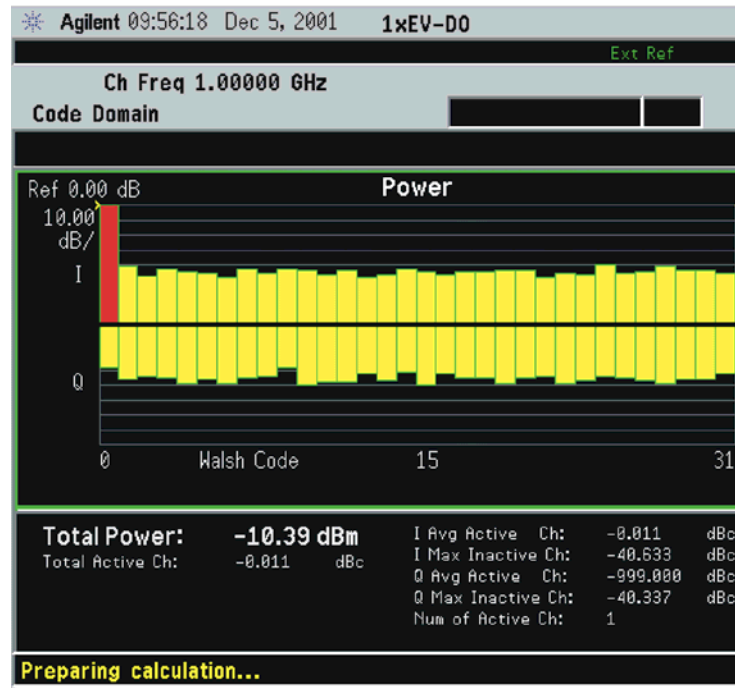
**View/Trace Key Menu**

Key Path: **Code Domain, View/Trace**

- **Power Graph & Metrics** - This is the default selection for the code domain measurement.

Figure 3-3

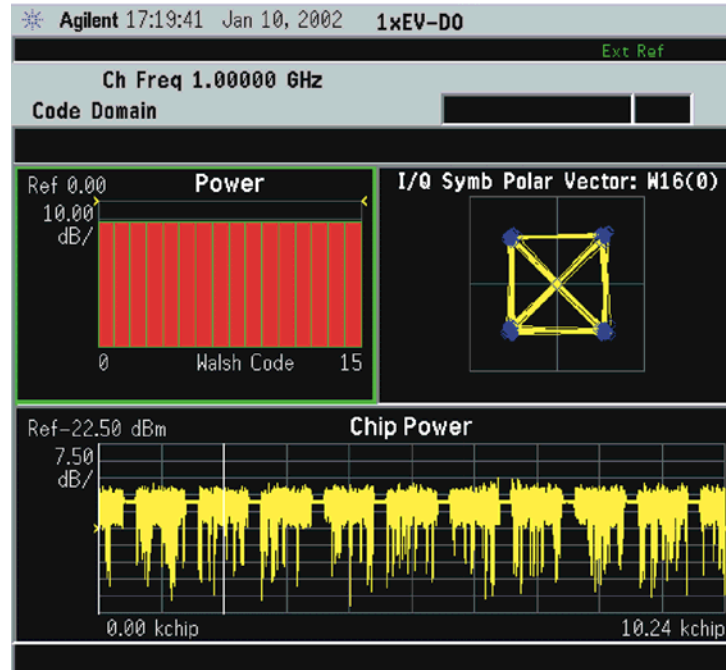
## Code Domain Measurement - Power Graph &amp; Metrics View





- **I/Q Polar & Power Graph** - Provides a combination view of the code domain power, I/Q symbol polar vector, and chip power graphs as shown in Figure 3-4.

**Figure 3-4 Code Domain Measurement - I/Q Polar & Power Graph View**



### Display Key Menu

Key Path: **Code Domain, Display**

- **Code Order** - Allows you to access the menu to set the Walsh code order to either **Hadamard** or **Bit Reverse**.
- **I/Q Combined Power Bar** - Allows you to toggle the I/Q combined power display function between **On** and **Off**. When set to **On**, the I and Q power bars are consolidated on the upper side of the horizontal axis. When set to **Off**, the I and Q power bars are shown on the upper side and the lower side of the horizontal axis, respectively.

**NOTE**

The following additional keys become active for **Power Graph & Metrics** or **I/Q Polar & Power Graph** view when the **Power** window is active:

- **SPAN X Scale**
  - **Scale/Div** - Allows you to set the horizontal scale by changing the value per division. The range is 16.0 to 64.0 Walsh codes per division. The default setting is 64.0.
  - **Ref Value** - Allows you to set the reference value ranging from -640.00 to 640.00. The default setting is 0.00.

Key Reference  
1xEV-DO Measurement Keys

- **Ref Position** - Allows you to set the reference value ranging from -640.00 to 640.00. The default setting is 0.00.
- **AMPLITUDE Y Scale**
  - **Scale/Div** - Allows you to set the vertical scale by changing the value per division. The range is 0.10 to 20.0 dB per division. The default setting is 10.00 dB.
  - **Ref Value** - Allows you to set the reference value ranging from -250.00 to 250.00 dB. The default setting is 0.00 dB.

---

**NOTE**

The following additional keys become active for **I/Q Polar & Power Graph** view when the **Chip Power** window is active:

- **SPAN X Scale**
  - **Scale/Div** - Allows you to set the horizontal scale by changing a symbol value per division. The range is 0.10 to 5000.00 chips per division with 0.01 resolution. The default setting is 1024.0 chips. However, since the **Scale Coupling** default is **On**, this value is automatically determined by the measurement result. When you set a value manually, **Scale Coupling** automatically changes to **Off**.
  - **Ref Value** - Allows you to set the chip reference value ranging from 0.00 to 50000.00 chips. The default setting is 0.000 chips. However, since the **Scale Coupling** default is **On**, this value is automatically determined by the measurement results. When you set a value manually, **Scale Coupling** automatically changes to **Off**.
  - **Ref Position** - Allows you to set the reference position to either **Left**, **Ctr** (center) or **Right**. The default setting is **Left**.
  - **Scale Coupling** - Allows you to toggle the scale coupling function between **On** and **Off**. The default setting is **On**. Upon pressing the **Restart** front panel key or the **Restart** softkey under the **Meas Control** menu, this function automatically determines the scale per division and reference values based on the measurement results. When you set a value to either **Scale/Div** or **Ref Value** manually, **Scale Coupling** automatically changes to **Off**.
- **AMPLITUDE Y Scale**
  - **Scale/Div** - Allows you to set the vertical scale by changing the value per division. The range is 0.10 to 20.00 dB. The default setting is 10.00 dB. However, since the **Scale Coupling** default is **On**, this value is automatically determined by the measurement result. When you set a value manually, **Scale Coupling** automatically changes to **Off**.
  - **Ref Value** - Allows you to set the reference value ranging from -250.00 to 250.00 dB. The default setting is 0.00 dB. However, since the **Scale Coupling** default is **On**, this value is automatically

determined by the measurement results. When you set a value manually, **Scale Coupling** automatically changes to **Off**.

- **Ref Position** - Allows you to set the reference position to either **Top**, **Ctr** (center) or **Bot** (bottom). The default setting is **Ctr**.
- **Scale Coupling** - Allows you to toggle the scale coupling function between **On** and **Off**. The default setting is **On**. Upon pressing the **Restart** front panel key or the **Restart** softkey under the **Meas Control** menu, this function automatically determines the scale per division and reference values based on the measurement results. When you set a value to either **Scale/Div** or **Ref Value** manually, **Scale Coupling** automatically changes to **Off**.

### Marker Key Menu

Key Path: **Code Domain, Marker**

- **Select 1 2 3 4** - Allows you to activate up to four markers with the corresponding numbers, respectively. The selected number is underlined and its function is defined by pressing the **Function** key. The default setting is 1.
- **Normal** - Allows you to activate the selected marker to read the power level and symbol code with the code layer. The marker position is controlled either by manual adjustment of the RPG knob or by direct entry of the Walsh code number via the front panel keypad.
- **Delta** - Allows you to read the differences in the power levels and symbols codes between the selected marker and the next.
- **Function** - Allows you to set the selected marker function to **Band Power**, **Noise**, or **Off**. The default setting is **Off**. The **Band Power** and **Noise** functions are not available for this measurement.
- **Trace** - Allows you to place the selected marker on the **Code Domain Power** or **Chip Power** trace. The default setting is **Code Domain Power**.
- **Off** - Allows you to turn off the selected marker.
- **Shape** - Allows you to access the menu to set the selected marker shape to **Diamond**, **Line**, **Square**, or **Cross**. The default setting is **Diamond**.
- **Marker All Off** - Allows you to turn off all of the markers.
- **Mkr->Despread** - While a maker is set on any active channel of the code domain power or chip power graph in the **Power Graph and Metrics** or **I/Q Polar & Power Graph** view, this key allows you to observe the Chip Power and the I/Q Symbol Polar Vector graphs with the Walsh code number for that active channel in other windows. The I/Q symbol polar vector graph is displayed for the symbol power specified by the measurement interval and measurement offset.

---

**NOTE** The front panel **Search** key performs a peak search when pressed. A marker will automatically be activated at the highest peak.

---

### Troubleshooting Hints

Uncorrelated interference may cause CW interference like local oscillator feedthrough or spurs. Another uncorrelated noise may be due to I/Q modulation impairments. Correlated impairments can be due to the phase noise on the local oscillator in the upconverter or I/Q modulator of the UUT. These will be analyzed by the code domain measurements along with the QPSK EVM measurements and others.

A poor phase error indicates a problem at the I/Q baseband generator, filters, and/or modulator in the transmitter circuitry of the UUT. The output amplifier in the transmitter can also create distortion that causes unacceptably high phase error. In a real system, a poor phase error will reduce the ability of a receiver to correctly demodulate the received signal, especially in marginal signal conditions.

### Code Domain Keys (Reverse Link)

---

**NOTE** This section describes making MS tests, also known as reverse link tests. When you are going to make BTS tests or forward link tests, see [“Code Domain Keys \(Forward Link\)” on page 163](#).

---



---

**NOTE** Select key path: **MEASURE, Code Domain** to access these menus.

---

### Meas Setup Key Menu

Key Path: **Code Domain, Meas Setup**

- **Meas Type** - Allows you to toggle the code domain power measurement type between **Rel** (relative) and **Abs** (absolute). When set to **Rel**, the measurement is made in the relative power in dBc. When set to **Abs**, the measurement is made in the absolute power in dBm.
- **Walsh Code Length** - Allows you to set the Walsh code length to either 4, 8, or 16. The parameter automatically sets the maximum value for **Walsh Code Number** when appropriate. When **Walsh Code Length** is set to 16 and **Walsh Code Number** is set to 0, the Pilot channel is automatically selected as the channel type.
- **Walsh Code Number** - Allows you to set the Walsh code number. The range is 0 to (**Walsh Code Length** – 1).
- **I/Q Branch** - Allows you to toggle the selection of the I/Q branch signals between **I**, **Q**, and **IQC** (I/Q Combined). The default selection is **I**.

When the user specifies **I** or **Q**, then both I/Q measured trace and reference points are projected on the I or Q axis, respectively.

When the user specifies **IQC**, the I/Q projection is skipped. Therefore, when the user measures a BPSK signal this parameter must be set to either **I** or **Q**. When the user measures QPSK or 8PSK signals, this parameter should be set to **IQC**.

This parameter is effective for symbol analysis, but is not effective for modulation type detection or code power calculation.

- **Meas Interval** - Allows you to set the time interval in slots over which the symbol power measurement is made. The range is 0.0 to the slots defined by **Capture Interval**. The marker lines reflecting this value are displayed in the symbol power graph of the **Code Domain (Quad View)** and **Demod Bits** displays. Refer to the illustration in **Meas Offset** below.
- **Meas Offset** - Allows you to set the number of offset slots to make a symbol power measurement. The range is 0 to **Capture Intvl** – 0.5 slots. The summation of **Meas Interval** and **Meas Offset** should be less than 32 slots. The marker lines shift left or right by this value in the symbol power graph of the **Code Domain (Quad View)** and **Demod Bits** displays.
- **I Long Code Mask** - Allows you to set the long code mask value for the I signal. The value ranges from 0x0000000000 to 0x3FFFFFFFFFFF (42 bits). This value is used in the long code generation process.
- **Q Long Code Mask** - Allows you to set the long code mask value for the Q signal. The value ranges from 0x0000000000 to 0x3FFFFFFFFFFF (42 bits). This value is used in the long code generation process.
- **Active Code Chan** - Allows you to access the menu of the following active channel identification functions.
  - **Auto** - Sets to automatically detect the active code channel(s). When the input power level is not stable, this detection method may not be effective.
  - **Combination** - Sets to use the active channels combined with the predefined active channel and those detected by the auto active channel detection function.
  - **Predefined** - Allows you to use the active code channels defined by the **Predefined Active Chan** key.
- **Predefined Active Chan** - Allows you to access a menu for setting code channels active or inactive for synchronization. This key is disabled when **Active Code Chan** is set to **Auto**. The selections available depend on the setting for **Physical Layer Subtype** under the **Mode Setup, Demod** key.

Key Reference  
1xEV-DO Measurement Keys

The following **Predefined Active Chan** selections are available when **Physical Layer Subtype** is set to **0/1**:

- **Pilot/RRI Chan (W16(0):I)** - Allows you to toggle the pilot/RRI channel activation between **On** (active) and **Off** (inactive).
- **DRC Chan (W16(8):Q)** - Allows you to toggle the DRC (data rate control) channel activation between **On** (active) and **Off** (inactive).
- **Ack Chan (W8(4):I)** - Allows you to toggle the acknowledge channel activation between **On** (active) and **Off** (inactive).
- **Data Chan (W4(2):Q)** - Allows you to toggle the data channel activation between **On** (active) and **Off** (inactive).

The following **Predefined Active Chan** selections are available when **Physical Layer Subtype** is set to **2**:

- **Pilot Chan (W16(0):I)** - Allows you to toggle the pilot channel activation between **On** (active) and **Off** (inactive).
- **DRC Chan (W16(8):Q)** - Allows you to toggle the DRC (data rate control) channel activation between **On** (active) and **Off** (inactive).
- **RRI Chan (W16(4):I)** - Allows you to toggle the acknowledge channel activation between **On** (active) and **Off** (inactive).
- **ACK/DSC Chan (W32(12):I)** - Allows you to toggle the data channel activation between **On** (active) and **Off** (inactive).
- **Aux-Pilot Chan (W32(28):I)** - Allows you to toggle the DRC (data rate control) channel activation between **On** (active) and **Off** (inactive).
- **Data Chan** - Displays a menu of Active Data Channel selections. The default is **B4(W4(2):Q)**. There is no toggle function to turn this selection **On** (active) or **Off** (inactive). Making any key selection will turn the **Data Chan** function **On** (active). You must select **Off** (inactive) to turn it off.

- B4(W4(2):Q)**
- Q4(W4(2))**
- Q2(W2(1))**
- Q4Q2(W4(2), W2(1))**
- E4E2(W4(2), W2(1))**
- Off**

- **Sync Start Slot** - Allows you to select and set the number of the slot at which the measurement will begin, and to toggle this function between **On** (active) and **Off** (inactive). When set to **OFF** (default), the measurement will begin when trigger or timing conditions are satisfied.

- **Capture Intvl** - Allows you to set the number of power control groups to make a symbol power measurement. The range is 2 to 32 slots in conjunction with the **Meas Interval** value. The maximum value is (32 – **Meas Interval**). The marker lines shift to the right or left by this value in the symbol power graph of the **Code Domain (Quad View)** and **Demod Bits** display.
- **Spectrum** - Allows you to toggle the spectrum function between **Normal** and **Invert**. This key, when set to **Invert**, conjugates the spectrum, which equivalently negates the quadrature component in demodulation. The correct setting (**Normal** or **Invert**) depends on whether the signal being input to the instrument has a high or low side mix.
- **Advanced** - Allows you to access the menu to set the following parameter.
  - **Symbol EVM Compensation** - Accesses keys that will allow de-selection of the default **Frequency Compensation** and **Phase Compensation** functions. To obtain raw un-compensated data, you must de-select these functions.
  - **Active Set Th** - When **Active Code Chan** is set to **Auto**, this key allows you to toggle the active channel identification function between **Auto** and **Man**. When set to **Auto**, the active channels are determined automatically by the internal algorithm. When set to **Man**, the active channel identification for each code channel is determined by a user definable threshold ranging from –100.00 dB to 0.00 dB.
  - **Chip Rate** - Allows you to change the chip rate. The range is 1.10592 to 1.35168 MHz.
  - **ADC Range** - Allows you to access the following selection menu to define one of the ADC ranging functions:
    - Auto** - Select this to automatically set the ADC range. For most FFT measurements, the auto feature should not be selected. An exception is when measuring a “bursty” signal, in which case **Auto** can maximize the time domain dynamic range, when FFT results are less important to you than time domain results.
    - Auto Peak** - Select this to set the ADC range automatically to the peak signal level. **Auto Peak** is a compromise that works well for both CW and burst signals.
    - Auto Peak Lock** - Select this to hold the ADC range automatically at the peak signal level. **Auto Peak Lock** is more stable than **Auto Peak** for CW signals, but should not be used for “bursty” signals.
    - Manual** - Allows you to access the selection menu of values, –6

Key Reference  
1xEV-DO Measurement Keys

to +24 dB for E4406A or None to +18 dB for PSA, to set the ADC range level. Also note that manual ranging is best for CW signals.

Table 3-3 table shows the factory default settings for code domain power measurements.

**Table 3-3 Code Domain Power Measurement Defaults**

Measurement Parameter	Factory Default Condition
View/Trace	Power Graph & Metrics
Display:	
Code Order	Hadamard
Consolidated Marker	On
Meas Setup:	
Meas Type	Rel (relative)
Walsh Code Length	16
Walsh Code Number	0
I/Q Branch	I
Meas Interval	1.0 slots
Meas Offset	0.0 slots
I Long Code Mask	0000000000
Q Long Code Mask	0000000000
Active Code Chan	Auto
Predefined Active Chan	(not available unless Active Code Chan is set to Auto)
Capture Intvl	5 slots
Trig Source	Free Run (Immediate)
Spectrum	Normal
Meas Control:	
Measure	Single
<b>Advanced</b>	
Active Set Th	Auto; ---- dB
Chip Rate	1.228800 MHz
ADC Range:	
Manual	-6 dB (for E4406A), None (for PSA)



### View/Trace Key Menu

Key Path: **Code Domain, View/Trace**

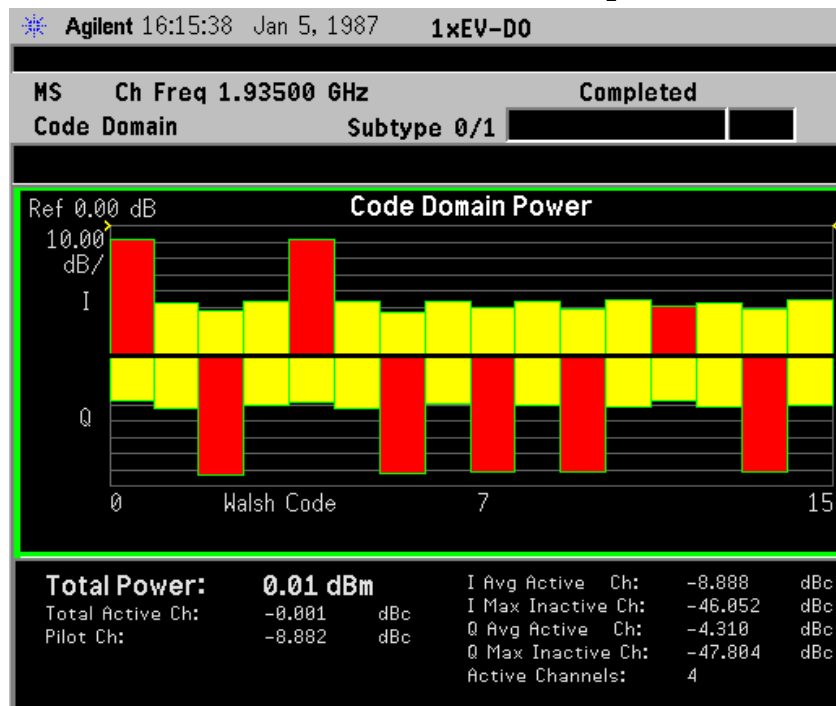
**NOTE**

Each of the following views contains multiple windows that can be selected by the **Next Window** key and made full size using the **Zoom** key.

- **Power Graph & Metrics** - Provides a combination view of the code domain power graph and the summary data as shown in [Figure 3-5](#).

**Figure 3-5**

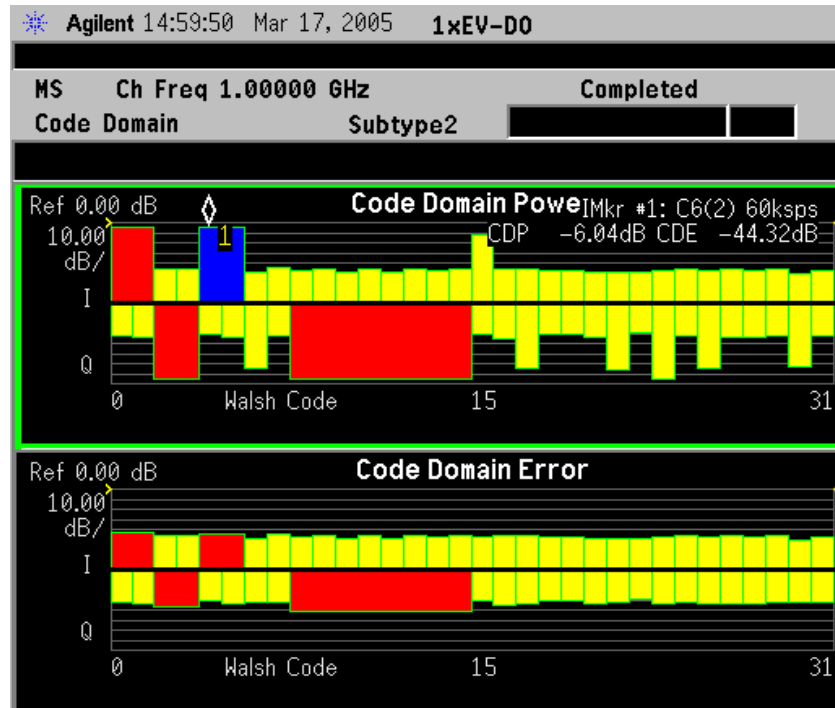
### Code Domain Measurement - Power Graph and Metrics View



Key Reference  
1xEV-DO Measurement Keys

- **CDP Graph & CDE Graph**- Provides a 2-pane view of the Code Domain Power and Code Domain Error graphs, and the summary data in the text window as shown in [Figure 3-6](#).

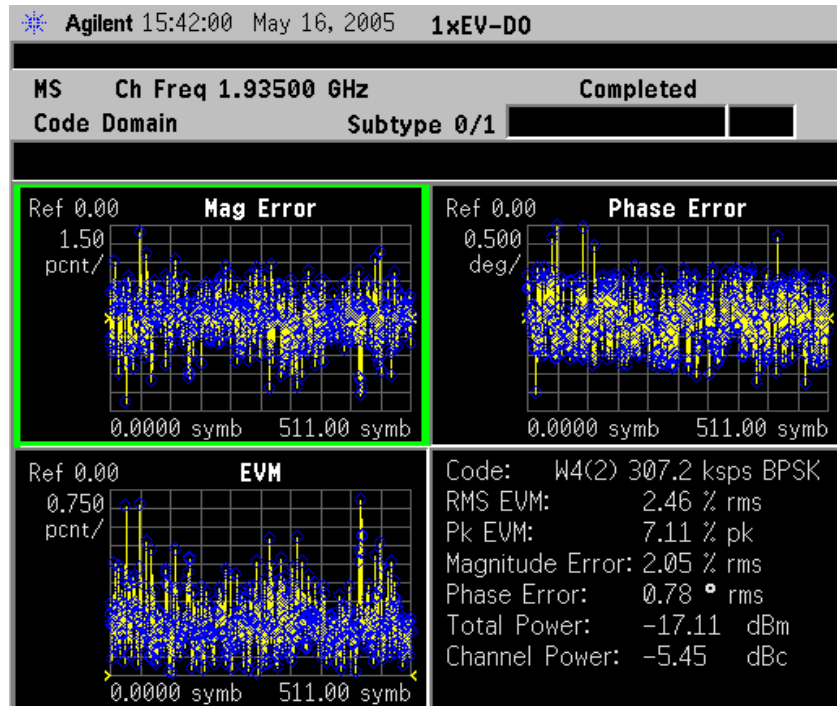
**Figure 3-6** Code Domain Measurement - CDP Graph and CDE Graph View



- **I/Q Error (Quad view)** - Provides a 4-pane view of the Magnitude Error, Phase Error, and EVM vs. Symbol graphs, and the summary data in the text window as shown in [Figure 3-6](#).

Figure 3-7

Code Domain Measurement - I/Q Error (Quad View)

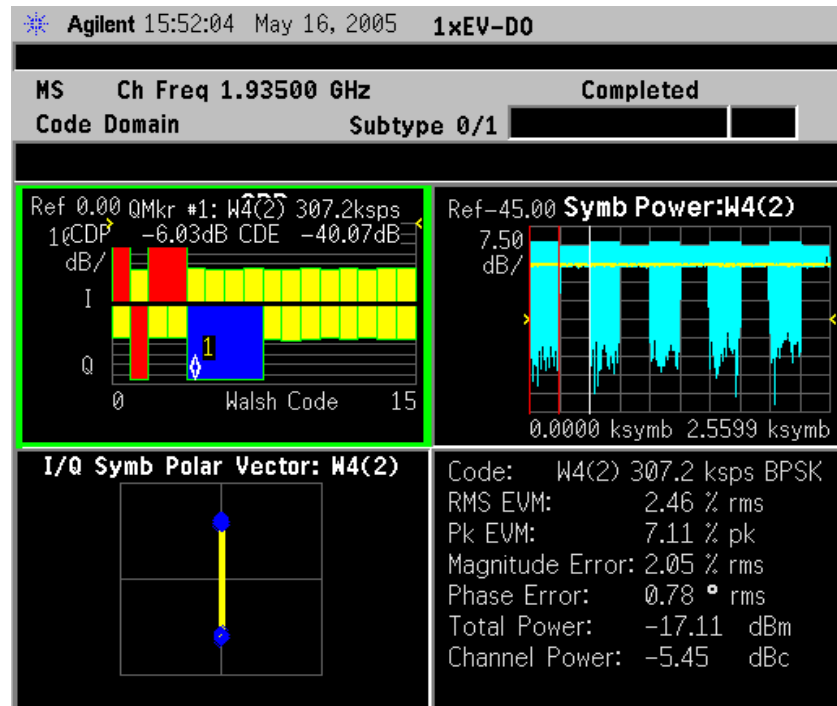


Key Reference  
1xEV-DO Measurement Keys

- **Code Domain (Quad View)** - Provides a combination view of the code domain power, symbol power, and I/Q symbol power polar vector graphs in the graph window, and the summary data for the code number, rms and peak EVM, magnitude error, phase error, absolute total power, and channel power in the text window as shown in [Figure 3-5](#).

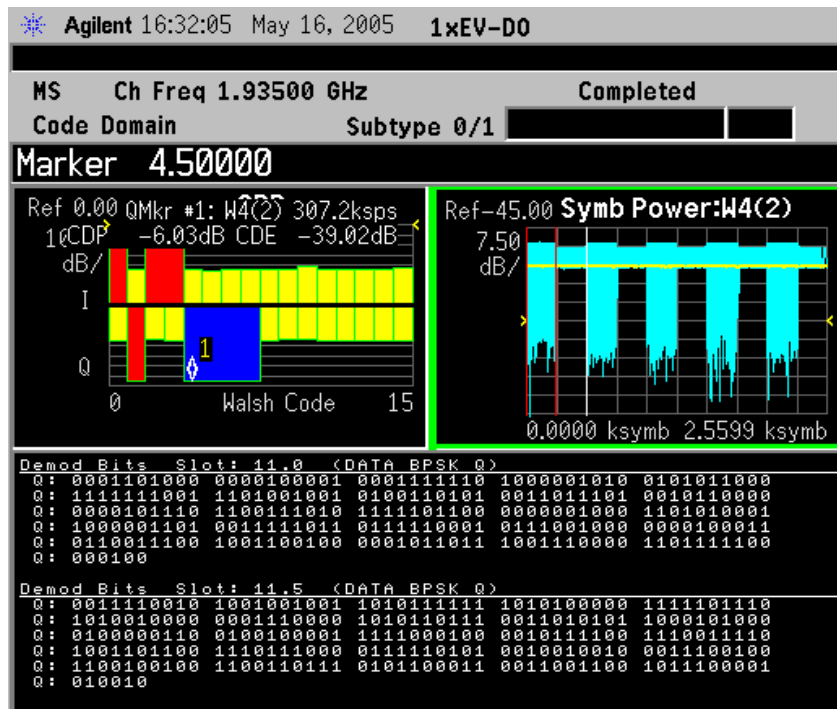
Figure 3-8

Code Domain Measurement - Code Domain (Quad View)



- **Demod Bits** - Provides a combination view of the code domain power and symbol power graphs, and the I/Q demodulated bit stream data with the corresponding slot or measure offset number in the power control groups, in the text window as shown in [Figure 3-9](#).

**Figure 3-9 Code Domain Measurement - Demod Bits View**



### Display Key Menu

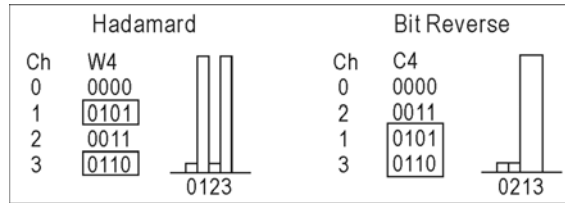
Key Path: **Code Domain, Display**

**NOTE** In symbol power measurements in the code domain, phase trajectories between constellation points are not significant to the measurement. Therefore, by default, the points per chip is always set to 1 and the chip dots is set to On.

**NOTE** When the **Power** graph window is active in the **Power Graph & Metrics**, **CDP Graph & CDE Graph**, or **Demod Bits** view, the **Display** key accesses the menu to allow the following settings:

- **Code Order** - Allows you to access the menu to set the Walsh code order to one of the following parameters.
  - **Hadamard** - Sets the Walsh code order function to the Hadamard format. The next figure shows code domain power graphs for Walsh Code 4 and OVSF Code 4 to illustrate their relationship.

This is the default setting.



— **Bit Reverse** - Sets the Walsh code order to the bit reversed format.

- **Consolidated Marker** - Allows you to toggle the consolidated marker function between **On** and **Off**. When set to **On**, the corresponding Walsh code channel power will be marked in the different color upon placing the marker at the consolidated Walsh code channel power. The default setting is **On**. The **Consolidated Marker** key is disabled when **Code Order** is set to **Bit Reverse**.

---

**NOTE** When the **Symbol Power** window is active in the **CDP Graph & CDE Graph** or **Demod Bits**, the **Display** key accesses the menu to allow the following settings:

---

- **Composite Chip Power** - Allows you to toggle the composite chip power display function between **On** and **Off**. The default setting is **On**.

---

**NOTE** When the **Demod Bits** window is active in the **Demod Bits** view (use the **Next Window** key to select the window), the **Display** key accesses a menu to allow you to display the bit stream measurement results:

---

- **Prev Page** - Returns one page back to the previous page of the measurement results.
- **Next Page** - Moves one page forward to the following page of the measurement results.
- **Scroll Up** - Moves one line upward on the current page of the measurement results by each pressing.
- **Scroll Down** - Moves one line downward on the current page of the measurement results by each pressing.
- **First Page** - Moves from the current page to the first page of the measurement results.
- **Last Page** - Moves from the current page to the last page of the measurement results.

---

**NOTE** When the **Code Domain Power** window is active in the **Power Graph & Metrics**, **CDP Graph & CDE Graph**, or **Demod Bits** views, the following settings are available:

---

- **I/Q Combined Power Bar** - Allows you to toggle the I/Q Combined

Power Bar display function between **On** and **Off**. The default setting is **On**.

- **AMPLITUDE Y Scale**
  - **Scale/Div** - Allows you to set the vertical scale by changing the value per division. The range is 0.10 to 20.0 dB per division. The default setting is 10.00 dB.
  - **Ref Value** - Allows you to set the reference value ranging from -250.00 to 250.00 dB. The default setting is 0.00 dB.

---

**NOTE**

---

The following additional keys become active when the Symbol Power window is active:

- **SPAN X Scale**
  - **Scale/Div** - Allows you to set the horizontal scale by changing a symbol value per division. The range is 0.10 to 5000.00 symbols per division with 0.01 resolution. The default setting is 11.90 symbols. However, since the **Scale Coupling** default is **On**, this value is automatically determined by the measurement result. When you set a value manually, **Scale Coupling** automatically changes to **Off**.
  - **Ref Value** - Allows you to set the symbol reference value ranging from 0.00 to 50000.00 symbols. The default setting is 0.000 symbol. However, since the **Scale Coupling** default is **On**, this value is automatically determined by the measurement results. When you set a value manually, **Scale Coupling** automatically changes to **Off**.
  - **Ref Position** - Allows you to set the reference position to either **Left**, **Ctr** (center) or **Right**. The default setting is **Left**.
  - **Scale Coupling** - Allows you to toggle the scale coupling function between **On** and **Off**. The default setting is **On**. Upon pressing the **Restart** front panel key or the **Restart** softkey under the **Meas Control** menu, this function automatically determines the scale per division and reference values based on the measurement results. When you set a value to either **Scale/Div** or **Ref Value** manually, **Scale Coupling** automatically changes to **Off**.
- **AMPLITUDE Y Scale**
  - **Scale/Div** - Allows you to set the vertical scale by changing the value per division. The range is 0.10 to 20.00 dB. The default setting is 10.00 dB. However, since the **Scale Coupling** default is **On**, this value is automatically determined by the measurement result. When you set a value manually, **Scale Coupling** automatically changes to **Off**.
  - **Ref Value** - Allows you to set the reference value ranging from

Key Reference  
1xEV-DO Measurement Keys

–250.00 to 250.00 dB. The default setting is 0.00 dB. However, since the **Scale Coupling** default is **On**, this value is automatically determined by the measurement results. When you set a value manually, **Scale Coupling** automatically changes to **Off**.

- **Ref Position** - Allows you to set the reference position to either **Top**, **Ctr** (center) or **Bot** (bottom). The default setting is **Ctr**.
- **Scale Coupling** - Allows you to toggle the scale coupling function between **On** and **Off**. The default setting is **On**. Upon pressing the **Restart** front panel key or the **Restart** softkey under the **Meas Control** menu, this function automatically determines the scale per division and reference values based on the measurement results. When you set a value to either **Scale/Div** or **Ref Value** manually, **Scale Coupling** automatically changes to **Off**.

---

**NOTE** The following additional keys become active for **CDP Graph & CDE Graph** view when either window is active:

---

- **SPAN X Scale**

- **Scale/Div** - Allows you to set the horizontal scale by changing a symbol value per division. The range is 0.10 to 5000.00 symbols per division with 0.01 symbol resolution. The default setting is 1.900 symbols. However, since the **Scale Coupling** default is **On**, this value is automatically determined by the measurement result. When you set a value manually, **Scale Coupling** automatically changes to **Off**.
- **Ref Value** - Allows you to set the symbol reference value ranging from 0.00 to 50000.0 symbols. The default setting is 0.00 symbol. However, since the **Scale Coupling** default is **On**, this value is automatically determined by the measurement results. When you set a value manually, **Scale Coupling** automatically changes to **Off**.
- **Ref Position** - Allows you to set the reference position to either **Left**, **Ctr** (center) or **Right**. The default setting is **Left**.
- **Scale Coupling** - Allows you to toggle the scale coupling function between **On** and **Off**. The default setting is **On**. Upon pressing the **Restart** front panel key or the **Restart** softkey under the **Meas Control** menu, this function automatically determines the scale per division and reference values based on the measurement results. When you set a value to either **Scale/Div** or **Ref Value** manually, **Scale Coupling** automatically changes to **Off**.

---

**NOTE** The following additional keys become active for **CDP Graph & CDE Graph** view when the `Code Domain Error` window is active:

---

- **AMPLITUDE Y Scale**

- **Scale/Div** - Allows you to set the vertical scale by changing the



value per division. The range is 0.0100 to 3600.0 degrees. The default setting is 5.00 degrees. However, since the **Scale Coupling** default is **On**, this value is automatically determined by the measurement result. When you set a value manually, **Scale Coupling** automatically changes to **Off**.

- **Ref Value** - Allows you to set the reference value ranging from -36000.0 to 36000.0 degrees. The default setting is 0.00 degrees. However, since the **Scale Coupling** default is **On**, this value is automatically determined by the measurement results. When you set a value manually, **Scale Coupling** automatically changes to **Off**.
- **Ref Position** - Allows you to set the reference position to either **Top**, **Ctr** (center) or **Bot** (bottom). The default setting is **Ctr**.
- **Scale Coupling** - Allows you to toggle the scale coupling function between **On** and **Off**. The default setting is **On**. Upon pressing the **Restart** front panel key or the **Restart** softkey under the **Meas Control** menu, this function automatically determines the scale per division and reference values based on the measurement results. When you set a value to either **Scale/Div** or **Ref Value** manually, **Scale Coupling** automatically changes to **Off**.

### Using the Print Function

When **View/Trace** is set to **Demod Bits**, the **Print Setup** front panel key provides a selection key to configure the print function:

- **Print Demod** - Allows you to toggle the print function between **Screen** and **Report**. The default setting is **Screen** to dump a screen image. To create a text file of the demodulated data bits, press **Print Setup**, **HCOPY Dest**, select = **Print To Key**, and toggle the **Print Demod** key to **Report**. A text file named “demodbit.txt” will be written to the destination drive selected.

### Marker Key Menu

Key Path: **Code Domain, Marker**

- **Select** - Allows you to activate up to four markers with the corresponding numbers, respectively. The selected number is underlined and its function is defined by pressing the **Function** key. The default setting is 1.
- **Normal** - Allows you to activate the selected marker to read the power level and symbol code with the code layer. The marker position is controlled either by manual adjustment of the RPG knob or by direct entry of the Walsh code number via the front panel keypad.
- **Delta** - Allows you to read the differences in the power levels and symbols codes between the selected marker and the next.
- **Function** - Allows you to set the selected marker function to **Band Power**, **Noise**, or **Off**. The default setting is **Off**. The **Band Power** and

**Noise** functions are not available for this measurement.

- **Trace** - Allows you to place the selected marker on the **Code Domain Power**, **Code Domain Error**, **Symbol Power**, **Chip Power**, **EVM**, **Phase Error**, or **Mag Error** trace. The default setting is **Code Domain Power**.
- **Off** - Allows you to turn off the selected marker.
- **Shape** - Allows you to access the menu to set the selected marker shape to **Diamond**, **Line**, **Square**, or **Cross**. The default setting is **Diamond**.
- **Marker All Off** - Allows you to turn off all of the markers.
- **Mkr->Despread** - While a maker is set on any active spread channel of the code domain power graph in the **Power Graph and Metrics**, **Code Domain (Quad View)**, or **Demod Bits** view, this key allows you to observe the Symbol Power and the I/Q Symbol Polar Vector graphs with the Walsh spread code number for that active channel in other windows. The I/Q symbol polar vector graph is displayed for the symbol power specified by the measurement interval and measurement offset.

---

**NOTE**

The front panel **Search** key performs a peak search when pressed. A marker will automatically be activated at the highest peak.

---

### Troubleshooting Hints

Uncorrelated interference may cause CW interference like local oscillator feedthrough or spurs. Another uncorrelated noise may be due to I/Q modulation impairments. Correlated impairments can be due to the phase noise on the local oscillator in the upconverter or I/Q modulator of the UUT. These will be analyzed by the code domain measurements along with the QPSK EVM measurements and others.

A poor phase error indicates a problem at the I/Q baseband generator, filters, and/or modulator in the transmitter circuitry of the UUT. The output amplifier in the transmitter can also create distortion that causes unacceptably high phase error. In a real system, a poor phase error will reduce the ability of a receiver to correctly demodulate the received signal, especially in marginal signal conditions.

## Intermodulation Keys (Radio Device = BTS only)

---

**NOTE** Select key path: **MEASURE**, **Intermod** to access these menus.

---

### Meas Setup Key Menu

Key Path: **Intermod**, **Meas Setup**

- **Avg Number** - Allows you to change the number of N averages to be made.
- **Avg Mode** - Allows you to toggle the averaging mode between **Exp** (exponential) and **Repeat**. This selection only effects on the averaging result after the number of N averages is reached. The N is set using the **Avg Number** key.
  - **Normal averaging**: Normal (linear) averaging is always used until the specified number of N averages is reached. When the **Measure** key under **Meas Control** is set to **Single**, data acquisition is stopped when the number of N averages is reached, thus **Avg Mode** has no effect in the single measurement mode.
  - **Exponential averaging**: When **Measure** is set to **Cont**, data acquisition will continue indefinitely. Exponential averaging is used with a weighting factor of N (the displayed count of averages stops at N). Exponential averaging weights new data more heavily than old data, which allows tracking of slow-changing signals. The weighting factor N is set using the **Avg Number** key.
  - **Repeat averaging**: When **Measure** is set to **Cont**, data acquisition will continue indefinitely. After the number of N averages is reached, all previous result data is cleared and the average count displayed is set back to 1. This is equivalent to being in **Measure Single** and pressing the **Restart** key each time the single measurement finishes.
- **Meas Mode** - Allows you to specify one of the following measurement modes:
  - **Auto** - Automatically identifies whether the intermodulation is caused by the two-tone or transmit intermodulation signals and that mode is labeled in the middle line of the **Meas Mode** key. When appropriate signals are not identified, “-----” is shown instead.
  - **Two-tone** - Measures the two-tone intermodulation products.
  - **Transmit IM** - Measures the transmit intermodulation products.
- **Reference** - Allows you to access the selection menu for the reference channel:
  - **Auto** - Select this to set the reference channel automatically to the

Key Reference  
1xEV-DO Measurement Keys

highest level signal in two base frequency signals.

- **Lower Freq** - Select this to set the reference channel to the base lower frequency signal.
- **Upper Freq** - Select this to set the reference channel to the base upper frequency signal.
- **Average** - Select this to set the reference channel to the average frequency signals, (base lower frequency signal + base upper frequency signal)/2.
- **Span** - Allows you to specify the frequency span in which intermodulation products are measured. The range is 100.000 kHz to 100.000 MHz with 1 Hz resolution.
- **Res BW** - Allows you to specify the resolution bandwidth in which intermodulation products are measured, and to toggle this function between **Auto** and **Man**. When set to **Auto**, the resolution bandwidth is automatically set according to the frequency span. The range is 100.0 Hz to 300.000 kHz with 1 Hz resolution.
- **Base Freq Auto Search** - Allows you to toggle the base frequency auto search function between **On** and **Off**. When set to **On**, the base frequency is automatically searched for.
- **Base Freq** - Allows you to specify the base frequency values with the followings items when **Base Freq Auto Search** is set to **Off**:
  - **Lower Freq (f0)** - Accepts a frequency value for the base lower frequency signal (f0).
  - **Upper Freq (f1)** - Accepts a frequency value for the base upper frequency signal (f1).
  - **Delta Freq (f1-f0)** - Automatically shows the difference between the base lower and base upper frequencies.
- **Advanced** - Allows you to access the menu to set the following items:
  - **Integ BW** - Allows you to specify the integration bandwidth ranging from 100.0 kHz to 5.000 MHz.

Table 3-4 shows the factory default settings for intermodulation measurements.

Table 3-4

**Intermodulation Measurement Defaults**

Measurement Parameter	Factory Default Condition
Display: IM Prod Ref	On
Meas Setup: Avg Number	10; On

Table 3-4

Intermodulation Measurement Defaults

Measurement Parameter	Factory Default Condition
Avg Mode	Repeat
Meas Mode	Two-tone, Transmit IM, or -----; Auto
Reference	Lower Freq or Upper Freq; Auto
Span	20.0000 MHz
Res BW	140.000 kHz; Auto
Base Freq Auto Search	On
Base Freq	(not available as Base Freq Auto Search is set to On)
<b>Advanced</b>	
Integ BW	1.23000 MHz

### View/Trace Key Menu

The **View/Trace** key is not available for this measurement.

### AMPLITUDE Y Scale Key Menu

Key Path: **Intermod, AMPLITUDE Y Scale**

- **Scale/Div** - Allows you to enter a numeric value to change the vertical display sensitivity. The range is 0.10 to 20.00 dB with 0.01 dB resolution. The default setting is 10.00 dB. However, since the **Scale Coupling** default is **On**, this value is automatically determined by the measurement result. When you set a value manually, **Scale Coupling** automatically changes to **Off**.
- **Ref Value** - Allows you to set the absolute power reference value ranging from -250.00 to 250.00 dBm with 0.01 dB resolution. The default setting is 10.00 dBm. However, since the **Scale Coupling** default is **On**, this value is automatically determined by the measurement result. When you set a value manually, **Scale Coupling** automatically changes to **Off**.
- **Ref Position** - Allows you to set the reference position to either **Top**, **Ctr** (center), or **Bot** (bottom). The default setting is **Top**.
- **Scale Coupling** - Allows you to toggle the scale coupling function between **On** and **Off**. The default setting is **On**. Upon pressing the **Restart** front panel key or **Restart** softkey under the **Meas Control** menu, the scale coupling function automatically determines the scale per division and reference values based on the measurement results. When you set a value to either **Scale/Div** or **Ref Value**

manually, **Scale Coupling** automatically changes to **Off**.

### Display Key Menu

Key Path: **Intermod, Display**

- **IM Prod Lines** - Allows you to toggle the intermodulation product lines display function between **On** and **Off**. When set to **On**, two pair of dual vertical lines with the integration bandwidth are shown on the third-order or fifth-order intermodulation products display.

### Marker Key Menu

Key Path: **Intermod, Marker**

- **Select 1 2 3 4** - Allows you to activate up to four markers with the corresponding numbers, respectively. The selected number is underlined and its function is defined by pressing the **Function** key. The default is 1.
- **Normal** - Allows you to activate the selected marker to read the time position and amplitude of the marker on the Signal envelope trace, for example. Marker position is controlled by the **RPG** knob.
- **Delta** - Allows you to read the differences in time positions and amplitudes between the selected marker and the next.
- **Function** - Allows you to define the selected marker function to be **Band Power**, **Noise**, or **Off**. The default is **Off**. For measuring **Band Power**, you need to place the **Normal** marker and then place the **Delta** marker.
- **Trace** - Allows you to place the selected marker on the **Spectrum** trace.
- **Off** - Allows you to turn off the selected marker.
- **Shape Diamond** - Allows you to access the menu to define the selected marker shape to be **Diamond**, **Line**, **Square**, or **Cross**. The default is **Diamond**.
- **Marker All Off** - Allows you to turn off all of the markers.

---

#### NOTE

The front panel **Search** key performs a peak search when pressed. A marker will automatically be activated at the highest peak.

---

### Troubleshooting Hints

Intermodulation distortion (IM) measurements can reveal the presence of degraded or defective parts in the transmitter section of the UUT. The following are examples of problems which, once indicated by IM testing, may require further attention:

- Faulty DC power supply control of the transmitter power amplifier.

- RF power controller of the pre-power amplifier stage.
- I/Q control of the baseband stage.
- Reduction in the gain and output power level of the amplifier due to a degraded gain control and/or increased distortion.
- Degradation of amplifier linearity and other performance characteristics.

Power amplifiers are one of the final stage elements of a base or mobile transmitter and play a critical part in meeting the important power and spectral efficiency specifications. Measuring the spectral response of these amplifiers to complex wideband signals is crucial to linking amplifier linearity and other performance characteristics to the stringent system specifications.

## Modulation Accuracy (Composite Rho)(forward link) Keys

---

**NOTE** This section describes making BTS tests, also known as forward link tests. When you are going to make MS tests or reverse link tests, see [“Modulation Accuracy \(Composite Rho\) \(reverse link\) Keys” on page 207.](#)

---

**NOTE** Select key path: **MEASURE, Mod Accuracy (Composite Rho)** to access these menus.

---

### Meas Setup Key Menu

Key Path: **Code Domain, Meas Setup**

---

**NOTE** The chip rate is fixed at 1.2288 MHz for SR1 in this measurement.

- **Avg Number** - Allows you to change the number of N averages to be made.
- **Avg Mode** - Allows you to toggle the averaging mode between **Exp** (exponential) and **Repeat**. This selection only effects on the averaging result after the number of N averages is reached. The N is set using the **Avg Number** key.
  - **Normal averaging**: Normal (linear) averaging is always used until the specified number of N averages is reached. When the **Measure** key under **Meas Control** is set to **Single**, data acquisition is stopped when the number of N averages is reached, thus **Avg Mode** has no effect in the single measurement mode.
  - **Exponential averaging**: When **Measure** is set to **Cont**, data acquisition will continue indefinitely. Exponential averaging is

used with a weighting factor of N (the displayed count of averages stops at N). Exponential averaging weights new data more heavily than old data, which allows tracking of slow-changing signals. The weighting factor N is set using the **Avg Number** key.

- **Repeat averaging:** When **Measure** is set to **Cont**, data acquisition will continue indefinitely. After the number of N averages is reached, all previous result data is cleared and the average count displayed is set back to 1. This is equivalent to being in **Measure Single** and pressing the **Restart** key each time the single measurement finishes.
- **Channel Type** - Allows you to access the menu to specify one of the channel types:
  - **Pilot** - Measurements are made on the pilot channel.
  - **MAC** - Measurements are made on the medium access control (MAC) channel for a full slot.
  - **Data** - Measurements are made on the data channel for a full slot.
  - **Preamble** - Measurements are made on the preamble chips overlaid on the data channel.
  - **Overall** - Measurements are made on all of the channel types for **Rho Overall-1** in the first half slot and **Rho Overall-2** in the second half slot shifted from the first slot as defined in 3GPP2 TSG-4.1.
- **Data Ch Type** - Allows you to access the menu to specify a data type, when **Channel Type** is set to **Data**, otherwise this is disabled.
  - **QPSK** - The data channel type is set to the quadrature phase shift keying.
  - **8PSK** - The data channel type is set to the eight phase shift keying.
  - **16QAM** - The data channel type is set to the sixteen quadrature amplitude modulation.
- **Preamble Len** - Allows you to specify the preamble length in number of chips from the first chip in the data channel, and to toggle the length detection mode between **Auto** and **Man** (manual). When set to **Auto**, the preamble length is automatically detected showing “----chips” on this key. When set to **Man**, you can enter a value in number of chips to specify the preamble length that is excluded from the data calculation. The selections are 0, 64, 128, 256, 512, and 1024.
- **Active Data Chan** - Allows you to toggle the active channel ID detection between **Auto** and **Predef** (predefined). When set to **Auto**, the active channel ID detection is automatically made for the data channel measurement. When set to **Predef**, the predefined active channel detection is used for the data channel measurement.



- **PN Offset** - Allows you to specify a multiplier for the Walsh code length in the unit of 64 chips. The range is 0 to 511. For example, set a value of 16 from the numeric keypad and press the **Enter** key. PN Offset 16 × 64 [chips] will be displayed in the screen annotation area. This value corresponds to the time offset between the trigger signal and the external frame signal.
- **Spectrum** - Allows you to toggle the spectrum function between **Normal** and **Invert**. When set to **Invert**, it conjugates the spectrum, which effectively inverts the quadrature component in demodulation. The correct setting (**Normal** or **Invert**) depends on whether the signal being input to the instrument has a high or low side mix.
- **Limits** - Allows you to access the menu to set the following limits:
  - **RMS EVM (Composite)** - Allows you to set the limit for composite RMS EVM measurement result. The range is 0.00 to 50.00%.
  - **Peak EVM (Composite)** - Allows you to set the limit for composite peak EVM measurement result. The range is 0.00 to 100.00%.
  - **Rho (Composite)** - Allows you to set the limit for composite rho measurement result. The range is 0.00000 to 1.00000.
  - **Freq Error** - Allows you to set the limit for peak code domain error measurement result. The range is 0.00 to 1.00 ppm.
  - **Timing** - Allows you to set the limit for timing error from the pilot channel used in the **Power Timing & Phase** view. The range is 0.0 to 500.0 ns.
  - **Phase** - Allows you to set the limit for phase error from the pilot channel used in the **Power Timing & Phase** view. The range is 0.00 to 3.00 rad.
  - **Pilot Offset** - Allows you to set the limit for pilot offset time used to offset from the trigger timing. The range is 0.0 to 100.0 μs.
  - **Max MAC Inactive Pwr** - Allows you to set the limit for maximum inactive channel power in the MAC channel. The range is -100.00 to 0.00 dB.
  - **Max Data Active Pwr** - Allows you to set the limit for maximum active channel power in the Data channel. The range is -100.00 to 0.00 dB.
  - **Min Data Active Pwr** - Allows you to set the limit for minimum active channel power in the Data channel. The range is -100.00 to (**Max Data Active Pwr**) dB.
- **Advanced** - Allows you to access the menu to change the following parameters:
  - **Rho Result I/Q Offset** - Allows you to toggle the I/Q origin offset

function between **Std** (standard) and **Exclude**. When set to **Std**, the measurement results for EVM and Rho take into account the I/Q origin offset. When set to **Exclude**, the measurement results for EVM and Rho do not take into account the I/Q origin offset, and the message “Rho excludes I/Q Offset” is displayed in the lower right-side graph display area.

- **Rho Overall Preamble Incl** - Allows you to toggle the preamble chips inclusion for the rho and rho overall measurements and calculations, between **On** and **Off**. When set to **On**, the rho and its overall-1 and overall-2 results will include the preamble chips. When set to **Off**, the preamble chips are excluded from the rho overall result calculations.
- **Chip Rate** - Allows you to change the chip rate ranging from 1.10592 to 1.35168 MHz.
- **Multi Channel Estimator** - Allows you to toggle the multi channel estimator function between **On** and **Off**. When set to **On**, the **Power Timing & Phase** view will be available, and the measurement accuracy will be improved, but measurement speed will be reduced.
- **ADC Range** - Allows you to access the following selection menu to define one of the ADC ranging functions:
  - Auto** - Select this to automatically set the ADC range. For most FFT measurements, the auto feature should not be selected. An exception is when measuring a “bursty” signal, in which case **Auto** can maximize the time domain dynamic range, when FFT results are less important to you than time domain results.
  - Auto Peak** - Select this to set the ADC range automatically to the peak signal level. **Auto Peak** is a compromise that works well for both CW and burst signals.
  - Auto Peak Lock** - Select this to hold the ADC range automatically at the peak signal level. **Auto Peak Lock** is more stable than **Auto Peak** for CW signals, but should not be used for “bursty” signals.
  - Manual** - Allows you to access the selection menu of values, –6 dB through +24 dB for E4406A or None through +18 dB for PSA, to set the ADC range level. Also note that manual ranging is best for CW signals.
- **Active Set Th** - Allows you to toggle the active channel identification function between **Auto** and **Man**. When set to **Auto**, the active channels are determined automatically by the internal algorithm. When set to **Man**, the active channel identification for each code channel is determined by a user definable threshold ranging from –100.00 dB to 0.00 dB.

Table 3-5 shows the factory default settings for modulation accuracy (composite rho) measurements.

**Table 3-5 Modulation Accuracy (Composite Rho) Measurement Defaults**

Measurement Parameter	Factory Default Condition
View/Trace	I/Q Measured Polar Graph
Display:	
Chip Offset	0 chips
Chip Interval	2048 chips
Chip Descrambling	Off
Pilot Channel Period	On (grayed out)
MAC Channel Period	Off (grayed out)
Data Channel Period	Off (grayed out)
I/Q Polar Vec/Constln	Vec & Constln
+45 deg Rot	Off
Full Vector (Background)	Off
I/Q Graph Phase Ref	Overall1 (grayed out)
Meas Setup:	
Avg Number	10; On
Avg Mode	Repeat
Channel Type	Pilot
Data Ch Type	QPSK
Preamble Len	---- chips, Auto
Active Data Chan	Auto
PN Offset	0 × 64 [chips]
Sync Start Slot	Off
Spectrum	Normal
Limits:	
RMS EVM (Composite)	50.0 pct
Peak EVM (Composite)	100.0 pct
Rho (Composite)	0.91200
Freq Error	0.05 ppm
Timing	50.0 ns

Table 3-5

## Modulation Accuracy (Composite Rho) Measurement Defaults

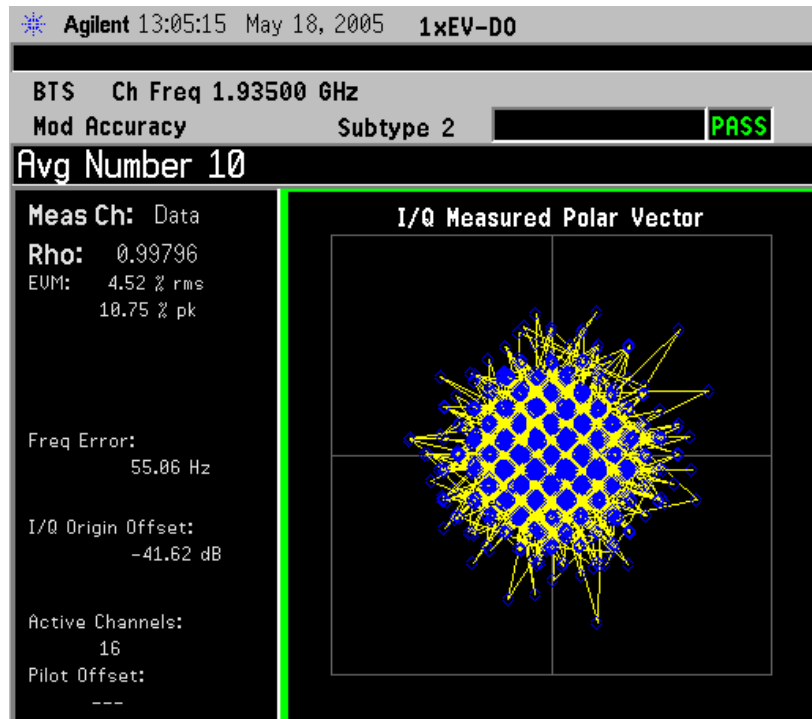
Measurement Parameter	Factory Default Condition
Phase	0.05 rad
Pilot Offset	10 $\mu$ s
Max MAC Inactive Pwr	-27.00 dB
Max Data Active Pwr	-14.56 dB
Min Data Active Pwr	-15.55 dB
Trig Source	Free Run (Immediate)
<b>Advanced</b>	
Rho Result I/Q Offset	Std
Rho Overall Preamble Incl	On
Chip Rate	1.228800 MHz
Multi Channel Estimator	Off
ADC Range: Manual	-6 dB (for E4406A), None (for PSA)
Active Set Th	---- dB; Auto

### View/Trace Key Menu

Key Path: Mod Accuracy (Composite Rho), View Trace

- **I/Q Measured Polar Graph** - Provides a combination view of an I/Q measured polar graph and the summary data as shown in [Figure 3-10](#).

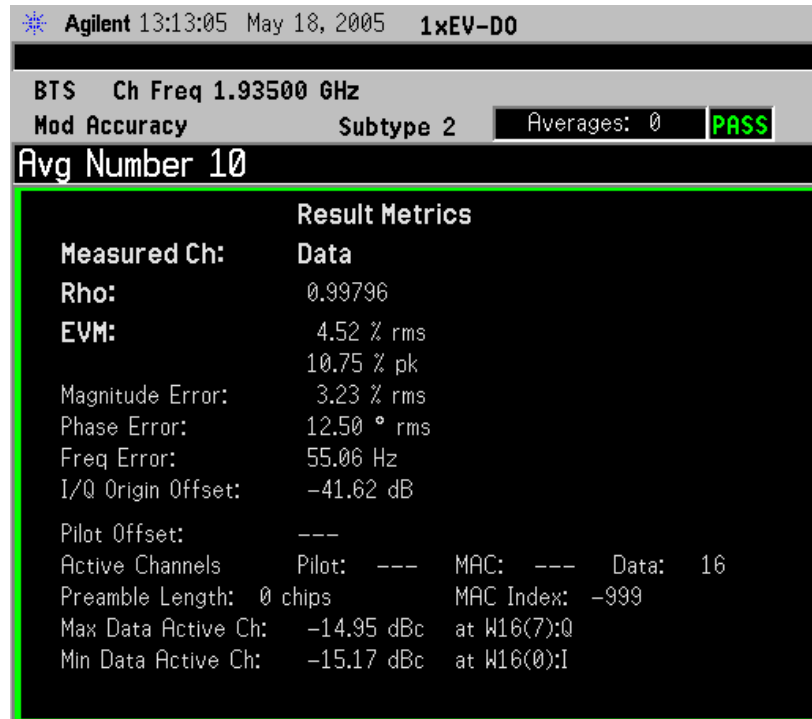
**Figure 3-10** Modulation Accuracy Measurement - I/Q Polar Graph View



Key Reference  
1xEV-DO Measurement Keys

- **Result Metrics** - One display window shows the measured channel name, rho, EVM, and other errors, as well as active channels. [Figure 3-11](#) shows an example of the result metrics view.

**Figure 3-11 Modulation Accuracy Measurement - Result Metrics View**



\*Meas Setup: View/Trace = Result Metrics  
Others = Factory default settings

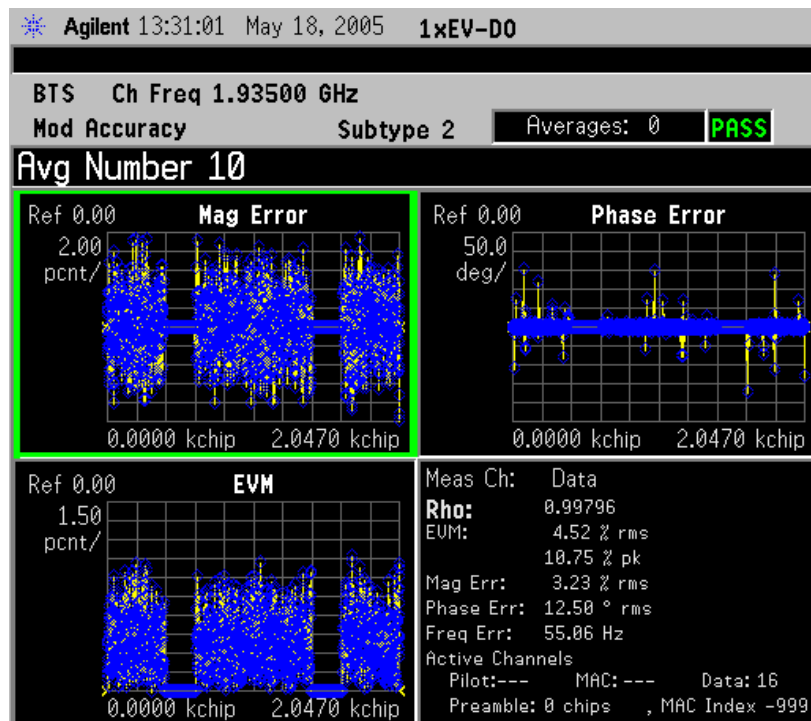
\*Input signal: -10.00 dBm, Pilot channel, 1xEV-DO

- **I/Q Error (Quad View)** - Four display windows show Mag Error, Phase Error, EVM graphs, and the summary data for the following:

composite rho  
rms and peak EVM  
phase error  
frequency error  
active channel types

These display windows are shown in [Figure 3-12](#).

**Figure 3-12 Modulation Accuracy Measurement - I/Q Error Quad View**



\*Meas Setup: View/Trace = I/Q Error (Quad View)  
Others = Factory default settings

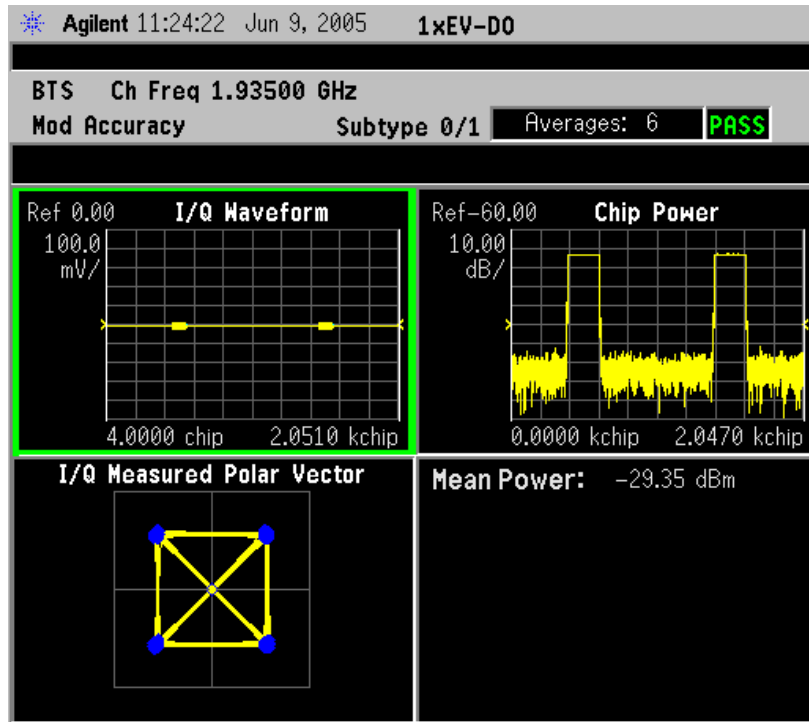
\*Input signal: -10.00 dBm, Pilot channel, 1xEV-DO

Any one of these windows can be selected by the **Next Window** key and made full size using the **Zoom** key.

Key Reference  
1xEV-DO Measurement Keys

- **I/Q Measured (Quad View)** - Provides a combination view of an I/Q power vs. chip, I/Q vector absolute power vs. chip, I/Q polar graphs in the graph windows, and the mean power result the summary window as shown in [Figure 3-13](#).

**Figure 3-13 Modulation Accuracy Measurement - I/Q Measured Quad View**



\*Meas Setup: View/Trace = I/Q Measured (Quad View),  
Channel Type = MAC,  
Others = Factory default settings

\*Input signal: -10.00 dBm, Pilot & MAC, 1xEV-DO

Any one of these windows can be selected by the **Next Window** key and made full size using the **Zoom** key.



- **Power Timing & Phase** - Provides a measurement result for the active channels with power levels, timing and phase errors in tabular form. Timing and phase are referenced to the Pilot channel as shown in [Figure 3-14](#). To activate this view, press **Meas Setup, More, Advanced**, and toggle **Multi Channel Estimator** to **On**.

**Figure 3-14 Modulation Accuracy Measurement - Power Timing & Phase View**

Code	Power (dB)	Timing (ns)	Phase (rad)
C4( 0)	-12.00	Reference	Reference
C4( 1)	-12.02	1.23	-0.010
C4( 2)	-12.06	1.08	-0.002
C4( 3)	-12.13	1.02	-0.007
C4( 4)	-12.18	-3.06	-0.004
C4( 5)	-12.03	-2.34	-0.003
C4( 6)	-12.03	-0.75	-0.003
C4( 7)	-12.05	0.21	0.002
C4( 8)	-11.97	-1.29	-0.001
C4( 9)	-12.04	0.47	-0.002
C4( 10)	-11.98	-2.19	0.001
C4( 11)	-12.14	0.19	-0.003
C4( 12)	-11.98	-1.54	-0.003
C4( 13)	-12.04	-1.15	-0.001
C4( 14)	-12.00	-1.06	0.001
C4( 15)	-12.02	-0.17	-0.001

\*Meas Setup: Advanced/Multi Channel Estimator = On,  
Channel Type = Data,  
View/Trace = Power Timing & Phase,  
Others = Factory default settings

\*Input signal: -10.00 dBm, Full slot, 1xEV-DO

## Display Key Menu

Key Path: **Mod Accuracy (Composite Rho), View Trace**

- **Chip Offset** - Allows you to specify the number of chips offset from the first chip in the captured slot to the displayed first chip. The range is dependent on the **Chip Interval** setting. This offset does not affect the **I/Q Error (Quad View)** display.
- **Chip Interval** - Allows you to specify the number of I/Q chips displayed for the captured I/Q waveforms. This offset does not affect the **I/Q Error (Quad View)** display.
- **Chip Descrambling** - Allows you to toggle the chip display function between **On** and **Off**. When set to **On**, the composite descrambled chips are shown in the polar view. When set to **Off**, the composite scrambled chips are shown in the polar view.
- **Pilot Channel Period** - Allows you to toggle the pilot channel display function between **On** and **Off**. When set to **On**, the polar vectors and constellations take into account the pilot channel in time domain. When set to **Off**, the polar vectors and constellations do not include the pilot channel in time domain. This is grayed out when **Chip Descrambling** is set to **Off**.
- **MAC Channel Period** - Allows you to toggle the medium access control (MAC) channel display function between **On** and **Off**. When set to **On**, the polar vectors and constellations take into account the MAC channel in time domain. When set to **Off**, the polar vectors and constellations do not include the MAC channel in time domain. This is grayed out when **Chip Descrambling** is set to **Off**.
- **Data Channel Period** - Allows you to toggle the data channel display function between **On** and **Off**. When set to **On**, the polar vectors and constellations take into account the data channel in time domain. When set to **Off**, the polar vectors and constellations do not include the data channel in time domain. This is grayed out when **Chip Descrambling** is set to **Off**.
- **I/Q Polar Vec/Constln** - Allows you to select one display with **Vec & Constln** (vector and constellation), **Vec** (vector), or **Constln** (constellation). This key does not affect the **I/Q Error (Quad View)** display.
- **+45 deg Rot** - Allows you to toggle the display rotation function between **On** and **Off**. When this is set to **On**, the I/Q polar vector or constellation graph is rotated by +45 degrees to see a rectangular display. The default setting is **Off**. This key does not affect the **I/Q Error (Quad View)** display.
- **Full Vector (Background)** - Allows you to toggle the full vector display function between **On** and **Off**. When set to **On**, the full vector traces in gray color are displayed in the background of the polar vector solid

traces in yellow. The default setting is **Off**. When **View/Trace** is set to **I/Q Measured Polar ConstIn**, this key is grayed out. This key does not affect the **I/Q Error (Quad View)** display.

- **I/Q Graph Phase Ref** - Allows you to toggle the phase reference of the polar graph between **Overall 1** and **Overall 2**. When set to **Overall 1**, the rho measurement will be made between the 0 chips to 512 chips of the first half slot. When set to **Overall 2**, the measurement will be done from 513 chips through 1023 chips. Select either of these references to make a stable measurement. This is grayed out when **Chip Descrambling** is set to **Off**.

---

**NOTE**

The following additional keys become active for **I/Q Error (Quad View)** or **I/Q Measured (Quad View)** view when either the EVM, Phase Error, Mag Error, I/Q Waveform, or Chip Power window is active:

---

- **SPAN X Scale**
  - **Scale/Div** - Allows you to set the horizontal scale by changing a chip value per division. The range is 0.00 to 500000.00 chips per division with 0.01 chip resolution. The default setting is 204.7 chips per division. However, since the **Scale Coupling** default **On**, this value is automatically determined by the measurement result. When you set a value manually, **Scale Coupling** automatically changes to **Off**.
  - **Ref Value** - Allows you to set the chip reference value ranging from 0.00 to 5000000.0 chips. The default setting is 0.00 chip. However, since the **Scale Coupling** default is **On**, this value is automatically determined by the measurement results. When you set a value manually, **Scale Coupling** automatically changes to **Off**.
  - **Ref Position** - Allows you to set the reference position to either **Left**, **Ctr** (center) or **Right**. The default setting is **Left**.
  - **Scale Coupling** - Allows you to toggle the scale coupling function between **On** and **Off**. The default setting is **On**. Upon pressing the **Restart** front panel key or the **Restart** softkey under the **Meas Control** menu, the scale coupling function automatically determines the scale per division and reference values based on the measurement results. When you set a value to either **Scale/Div** or **Ref Value** manually, **Scale Coupling** automatically changes to **Off**.

---

**NOTE**

The following additional keys become active for **I/Q Error (Quad View)** view when either the EVM or Mag Error window is active:

---

- **AMPLITUDE Y Scale**
  - **Scale/Div** - Allows you to set the vertical scale by changing the value per division. The range is 0.100 to 50.0% per division. The

default setting is 5.00%. However, since the **Scale Coupling** default is **On**, this value is automatically determined by the measurement result. When you set a value manually, **Scale Coupling** automatically changes to **Off**.

- **Ref Value** - Allows you to set the reference value ranging from 0.00 to 500.0%. The default setting is 0.00%. However, since the **Scale Coupling** default is **On**, this value is automatically determined by the measurement results. When you set a value manually, **Scale Coupling** automatically changes to **Off**.
- **Ref Position** - Allows you to set the reference position to either **Top**, **Ctr** (center) or **Bot** (bottom). For the EVM graph, the default setting is **Bot**. For the Mag Error graph, the default setting is **Ctr**.
- **Scale Coupling** - Allows you to toggle the scale coupling function between **On** and **Off**. The default setting is **On**. Upon pressing the **Restart** front panel key or the **Restart** softkey under the **Meas Control** menu, the scale coupling function automatically determines the scale per division and reference values based on the measurement results. When you set a value to either **Scale/Div** or **Ref Value** manually, **Scale Coupling** automatically changes to **Off**.

## NOTE

The following additional keys become active for **I/Q Error (Quad View)** view when the Phase Error window is active:

- **AMPLITUDE Y Scale**

- **Scale/Div** - Allows you to set the vertical scale by changing the value per division. The range is 0.01 to 3600.0 degrees. The default setting is 5.00 degrees per division. However, since the **Scale Coupling** default is **On**, this value is automatically determined by the measurement result. When you set a value manually, **Scale Coupling** automatically changes to **Off**.
- **Ref Value** - Allows you to set the reference value ranging from -36000 to 36000 degrees. The default setting is 0.00 degrees. However, since the **Scale Coupling** default is **On**, this value is automatically determined by the measurement results. When you set a value manually, **Scale Coupling** automatically changes to **Off**.
- **Ref Position** - Allows you to set the reference position to either **Top**, **Ctr** (center) or **Bot** (bottom). The default setting is **Ctr**.
- **Scale Coupling** - Allows you to toggle the scale coupling function between **On** and **Off**. The default setting is **On**. Upon pressing the **Restart** front panel key or the **Restart** softkey under the **Meas Control** menu, the scale coupling function automatically determines the scale per division and reference values based on the measurement results. When you set a value to either **Scale/Div** or **Ref Value** manually, **Scale Coupling** automatically changes to

Off.

---

NOTE

---

The following additional keys become active for **I/Q Measured (Quad View)** view when the **I/Q Waveform** window is active:

- **AMPLITUDE Y Scale**

- **Scale/Div** - Allows you to set the vertical scale by changing the voltage value per division. The range is 1.00 nV to 20.00 V per division. The default setting is 100.00 mV. However, since the **Scale Coupling** default is **On**, this value is automatically determined by the measurement result. When you set a value manually, **Scale Coupling** automatically changes to **Off**.
- **Ref Value** - Allows you to set the reference value ranging from -250.00 to 250.00 V. The default setting is 0.00 V. However, since the **Scale Coupling** default is **On**, this value is automatically determined by the measurement results. When you set a value manually, **Scale Coupling** automatically changes to **Off**.
- **Ref Position** - Allows you to set the reference position to either **Top**, **Ctr** (center) or **Bot** (bottom). The default setting is **Ctr**.
- **Scale Coupling** - Allows you to toggle the scale coupling function between **On** and **Off**. The default setting is **On**. Upon pressing the **Restart** front panel key or the **Restart** softkey under the **Meas Control** menu, the scale coupling function automatically determines the scale per division and reference values based on the measurement results. When you set a value to either **Scale/Div** or **Ref Value** manually, **Scale Coupling** automatically changes to **Off**.

---

NOTE

---

The following additional keys become active for **I/Q Measured (Quad View)** view when the **Chip Power** window is active:

- **AMPLITUDE Y Scale**

- **Scale/Div** - Allows you to set the vertical scale by changing the power value per division. The range is 0.10 to 20.00 dB per division. The default setting is 10.00 dB. However, since the **Scale Coupling** default is **On**, this value is automatically determined by the measurement result. When you set a value manually, **Scale Coupling** automatically changes to **Off**.
- **Ref Value** - Allows you to set the reference value ranging from -250.00 to 250.00 dB. The default setting is 0.00 dB. However, since the **Scale Coupling** default is **On**, this value is automatically determined by the measurement results. When you set a value manually, **Scale Coupling** automatically changes to **Off**.
- **Ref Position** - Allows you to set the reference position to either **Top**, **Ctr** (center) or **Bot** (bottom). The default setting is **Ctr**.

- **Scale Coupling** - Allows you to toggle the scale coupling function between **On** and **Off**. The default setting is **On**. Upon pressing the **Restart** front panel key or the **Restart** softkey under the **Meas Control** menu, the scale coupling function automatically determines the scale per division and reference values based on the measurement results. When you set a value to either **Scale/Div** or **Ref Value** manually, **Scale Coupling** automatically changes to **Off**.

### Marker Key Menu

Key Path: **Mod Accuracy (Composite Rho), Marker**

- **Select** - Allows you to activate up to four markers with the corresponding numbers, respectively. The selected number is underlined and its function is defined by pressing the **Function** key. The default setting is 1.
- **Normal** - Allows you to activate the selected marker to read the magnitude or phase error and the number of chips of the marker position on the selected trace, for example. Marker position is controlled by the RPG knob.
- **Delta** - Allows you to read the differences in the magnitude or phase errors and the number of chips between the selected marker and the next.
- **Function** - Allows you to set the selected marker function to **Band Power**, **Noise**, or **Off**. The default setting is **Off**. The **Band Power** and **Noise** functions are not available for this measurement.
- **Trace** - Allows you to place the selected marker on the **EVM**, **Phase Error**, or **Mag Error** trace. The default setting is **EVM**.
- **Off** - Allows you to turn off the selected marker.
- **Shape** - Allows you to access the menu to set the selected marker shape to **Diamond**, **Line**, **Square**, or **Cross**. The default setting is **Diamond**.
- **Marker All Off** - Allows you to turn off all of the markers.

### Troubleshooting Hints

A poor phase error often indicates a problem with the I/Q baseband generator, filters, and/or modulator in the transmitter circuitry of the UUT. The output amplifier in the transmitter can also create distortion that causes unacceptably high phase error. In a real system, a poor phase error will reduce the ability of a receiver to correctly demodulate the received signal, especially in marginal signal conditions.

## Modulation Accuracy (Composite Rho) (reverse link) Keys

---

**NOTE** This section describes making MS tests, also known as reverse link tests. When you are going to make BTS tests or forward link tests, see “[Modulation Accuracy \(Composite Rho\)\(forward link\) Keys](#)” on page 191.

---

**NOTE** Select key path: **MEASURE, Mod Accuracy (Composite Rho)** to access these menus.

---

### Meas Setup Key Menu

Key Path: **Mod Accuracy (Composite Rho), Meas Setup**

---

**NOTE** The chip rate is fixed at 1.2288 MHz for SR1 in this measurement.

---

- **Avg Number** - Allows you to change the number of N averages to be made.
- **Avg Mode** - Allows you to toggle the averaging mode between **Exp** (exponential) and **Repeat**. This selection only effects on the averaging result after the number of N averages is reached. The N is set using the **Avg Number** key.
  - **Normal averaging:** Normal (linear) averaging is always used until the specified number of N averages is reached. When the **Measure** key under **Meas Control** is set to **Single**, data acquisition is stopped when the number of N averages is reached, thus **Avg Mode** has no effect in the single measurement mode.
  - **Exponential averaging:** When **Measure** is set to **Cont**, data acquisition will continue indefinitely. Exponential averaging is used with a weighting factor of N (the displayed count of averages stops at N). Exponential averaging weights new data more heavily than old data, which allows tracking of slow-changing signals. The weighting factor N is set using the **Avg Number** key.
  - **Repeat averaging:** When **Measure** is set to **Cont**, data acquisition will continue indefinitely. After the number of N averages is reached, all previous result data is cleared and the average count displayed is set back to 1. This is equivalent to being in **Measure Single** and pressing the **Restart** key each time the single measurement finishes.
- **Active Code Chan** - Allows you to access the menu of the following active channel identification functions.
  - **Auto** - Sets to automatically detect the active code channel(s). When the input power level is not stable, this detection method

may not be effective.

- **Combination** - Sets to use the active channels combined with the predefined active channel and those detected by the auto active channel detection function.
- **Predefined** - Allows you to use the active code channels defined by the **Predefined Active Chan** key.
- **Predefined Active Chan** - Allows you to access a menu for setting code channels active or inactive for synchronization. This key is disabled when **Active Code Chan** is set to **Auto**. The selections available depend on the setting for **Physical Layer Subtype** under the **Mode Setup, Demod** key.

The following **Predefined Active Chan** selections are available when **Physical Layer Subtype** is set to **0/1**:

- **Pilot/RRI Chan (W16(0):I)** - Allows you to toggle the pilot/RRI channel activation between **On** (active) and **Off** (inactive).
- **DRC Chan (W16(8):Q)** - Allows you to toggle the DRC (data rate control) channel activation between **On** (active) and **Off** (inactive).
- **Ack Chan (W8(4):I)** - Allows you to toggle the acknowledge channel activation between **On** (active) and **Off** (inactive).
- **Data Chan (W4(2):Q)** - Allows you to toggle the data channel activation between **On** (active) and **Off** (inactive).

The following **Predefined Active Chan** selections are available when **Physical Layer Subtype** is set to **2**:

- **Pilot Chan (W16(0):I)** - Allows you to toggle the pilot channel activation between **On** (active) and **Off** (inactive).
- **DRC Chan (W16(8):Q)** - Allows you to toggle the DRC (data rate control) channel activation between **On** (active) and **Off** (inactive).
- **RRI Chan (W16(4):I)** - Allows you to toggle the acknowledge channel activation between **On** (active) and **Off** (inactive).
- **ACK/DSC Chan (W32(12):I)** - Allows you to toggle the data channel activation between **On** (active) and **Off** (inactive).
- **Aux-Pilot Chan (W32(28):I)** - Allows you to toggle the DRC (data rate control) channel activation between **On** (active) and **Off** (inactive).
- **Data Chan** - Displays a menu of Active Data Channel selections. The default is B4(W4(2):Q). There is no toggle function to turn this selection **On** (active) or **Off** (inactive). Making any key selection will turn the **Data Chan** function **On** (active). You must select **Off** (inactive) to turn it off.



- B4(W4(2):Q)
  - Q4(W4(2))
  - Q2(W2(1))
  - Q4Q2(W4(2), W2(1))
  - E4E2(W4(2), W2(1))
  - Off
- **Sync Start Slot** - Allows you to select and set the number of the slot at which the measurement will begin, and to toggle this function between **On** (active) and **Off** (inactive). When set to **OFF** (default), the measurement will begin when trigger or timing conditions are satisfied.
  - **Limits** - Allows you to access the menu to set the following limits:
    - **RMS EVM (Composite)** - Allows you to set the limit for composite RMS EVM measurement result. The range is 0.00 to 50.00%.
    - **Peak EVM (Composite)** - Allows you to set the limit for composite peak EVM measurement result. The range is 0.00 to 100.00%.
    - **Rho (Composite)** - Allows you to set the limit for composite rho measurement result. The range is 0.00000 to 1.00000.
    - **Peak CDE** - Allows you to set the limit for peak code domain error measurement result. The range is -100.0 to 0.0 dBm.
    - **Freq Error** - Allows you to set the limit for frequency error measurement result. The range is 0.00 Hz to 10.00 kHz.
    - **Pilot Offset** - Allows you to set the limit for pilot offset time from the trigger timing. The range is 0.0 to 100.0 ms.
    - **Timing** - Allows you to set the limit for timing error from the pilot channel used in the **Power Timing & Phase** view. The range is 0.0 to 500.0 ns.
    - **Phase** - Allows you to set the limit for phase error from the pilot channel used in the **Power Timing & Phase** view. The range is 0.00 to 3.00 rad.
    - **Inactive CDP** - Allows you to set the limit for inactive channel code domain power measurement result. The range is -100.0 to 0.00 dBm.

The following limit selections are available when **Physical Layer Subtype** is set to **0/1**:

- **RRI/Pit Pwr Tolerance** - Allows you to set the tolerance for RRI (reverse rate indicator) and pilot power ratio measurement result. The range is 0.00 to 3.00 dB.
- **Active CDP Tolerance** - Allows you to set the tolerance for each

Key Reference  
1xEV-DO Measurement Keys

active code domain power level with its channel gain defined by **DRC Chan Gain**, **ACK Chan Gain**, or **Data Chan Gain**, respectively. The range is 0.00 to 3.00 dB.

- **DRC Chan Gain** - Allows you to set the power gain level of the DRC (data rate control) channel relative to the pilot channel power level. The range is -10.00 to 10.00 dB.
- **ACK Chan Gain** - Allows you to set the power gain level of the ACK (acknowledge) channel relative to the pilot channel power level. The range is -10.00 to 10.00 dB.
- **Data Chan Gain** - Allows you to set the power gain level of the data channel relative to the pilot channel power level. The range is -10.00 to 10.00 dB.
- **I Long Code Mask** - Allows you to set the long code mask value for the I signal. The value ranges from 0x0000000000 to 0x3FFFFFFFFF (42 bits). This value is used in the long code generation process.
- **Q Long Code Mask** - Allows you to set the long code mask value for the Q signal. The value ranges from 0x0000000000 to 0x3FFFFFFFFF (42 bits). This value is used in the long code generation process.
- **Spectrum** - Allows you to toggle the spectrum function between **Normal** and **Invert**. When set to **Invert**, it conjugates the spectrum, which effectively inverts the quadrature component in demodulation. The correct setting (**Normal** or **Invert**) depends on whether the signal being input to the instrument has a high or low side mix.
- **Advanced** - Allows you to access the menu to change the following parameters:
  - EVM Result I/Q Offset** - Allows you to toggle the I/Q origin offset function between **Std** (standard) and **Exclude**. When set to **Std**, the measurement results for the error vector magnitude, rho, and code domain error take into account the I/Q origin offset. When set to **Exclude**, the measurement results for EVM, Rho, and CDE do not take into account the I/Q origin offset, and the message “EVM excludes I/Q Offset” is displayed in the lower right graph display area. The default setting is **Std**.
  - Active Set Th** - Allows you to toggle the active channel identification function between **Auto** and **Man** (manual). When set to **Auto**, the active channels are determined automatically by the internal algorithm. When set to **Man**, the active channel identification for each code channel is determined by a user definable threshold ranging from -100.00 to 0.00 dB.
  - Chip Rate** - Allows you to change the chip rate ranging from 1.10592 to 1.35168 MHz.

- ❑ **ADC Range** - Allows you to access the following selection menu to define one of the ADC ranging functions:
  - **Auto** - Select this to automatically set the ADC range. For most FFT measurements, the auto feature should not be selected. An exception is when measuring a “bursty” signal, in which case **Auto** can maximize the time domain dynamic range, when FFT results are less important to you than time domain results.
  - **Auto Peak** - Select this to set the ADC range automatically to the peak signal level. **Auto Peak** is a compromise that works well for both CW and burst signals.
  - **Auto Peak Lock** - Select this to hold the ADC range automatically at the peak signal level. **Auto Peak Lock** is more stable than **Auto Peak** for CW signals, but should not be used for “bursty” signals.
  - **Manual** - Allows you to access the selection menu of values, –6 to +24 dB for E4406A or None to +18 dB for PSA, to set the ADC range level. Also note that manual ranging is best for CW signals.
- ❑ **Multi Channel Estimator ON/OFF** - Allows you toggle the **Multi Channel Estimator** function **On** or **Off**. More accurate measurements are produced when this function is **On**, but the measurement time increases. The default is **Off**.

---

**TIP** Use the **Multi Channel Estimator** to improve phase measurement accuracy when you are measuring a multi-channel signal.

---

- **On**- Individual code channels are aligned to the pilot channel to improve the phase error of the channels.
- **Off** - Phase information for individual channels is computed based on the phase relationship of a single channel to the pilot.
- ❑ **Timing Estimation** - Allows you to select a more accurate basis for the timing estimation function. This function is only available when **Mode Setup, Advanced, Multi Channel Estimator** is set to **On**.
  - **Ch-by-Ch**- Code channel timing is calculated for each channel individually. This increases measurement time, but also increases accuracy.
  - **Global** - Code channel timing is estimated for all channels simultaneously. This method is the default when **Multi Channel Estimator** is set to **On**.

---

**TIP** Use **Ch-by-Ch Timing Estimation** to improve phase measurement accuracy when you are measuring multi-channel signals, especially when you suspect timing error is contributing to poor measurement

results.

**▣ Freq Err Tol Range**

This key toggles between **Wide**, **Normal** and **Narrow** settings for Frequency Error tolerance. To accurately demodulate more complex signals which require more stringent tolerance for frequency error, like multiple channels on the same carrier, select **Normal**, or **Narrow**. You can select **Wide** for use with signals that are simpler with greater frequency error tolerance.

[Table 3-6](#) shows the factory default settings for modulation accuracy (composite rho) measurements.

**Table 3-6 Modulation Accuracy (Composite Rho) Measurement Defaults**

Measurement Parameter	Factory Default Condition
View/Trace	I/Q Measured Polar Graph
Display:	
I/Q Polar Vec/Constln	Vec & Constln
Chip Offset	0 chips
Chip Interval	2048 chips
+45 deg Rot	Off
Full Vector (Background)	Off
Meas Setup:	
Avg Number	10; On
Avg Mode	Repeat
Active Code Chan	Auto
Predefined Active Chan	
Pilot Chan (W16(0): I)	On
DRC Chan (W16(8): Q)	On
Ack Chan (W8(4): I)	On
Data Chan (W4(2): Q)	On
Sync Start Slot	Off
Limits:	
RMS EVM (Composite)	50.0 pcent (%)
Peak EVM (Composite)	100.0 pcent
Rho (Composite)	0.94400
Peak CDE	0.00 dB
Freq Error	300.0 Hz

**Table 3-6 Modulation Accuracy (Composite Rho) Measurement Defaults**

<b>Measurement Parameter</b>	<b>Factory Default Condition</b>
Pilot Offset	1.000 $\mu$ s
Inactive CDP	-23.00 dBc
RRI/Plt Pwr Tolerance	0.25 dB
Active CDP Tolerance	0.25 dB
DRC Chan Gain	3.00 dB
ACK Chan Gain	3.00 dB
Data Chan Gain	3.75 dB
Trig Source	Free Run (Immediate)
I Long Code Mask	0000000000
Q Long Code Mask	0000000000
Spectrum	Normal
<b>Advanced</b>	
EVM Result I/Q Offset	Std
Active Set Th	---- dB; Auto
Chip Rate	1.228800 MHz
ADC Range: Manual	-6 dB (for E4406A), None (for PSA)
Multi Channel Estimator	Off
Timing Estimation	Global
Frequency Compensation	On
Phase Compensation	On

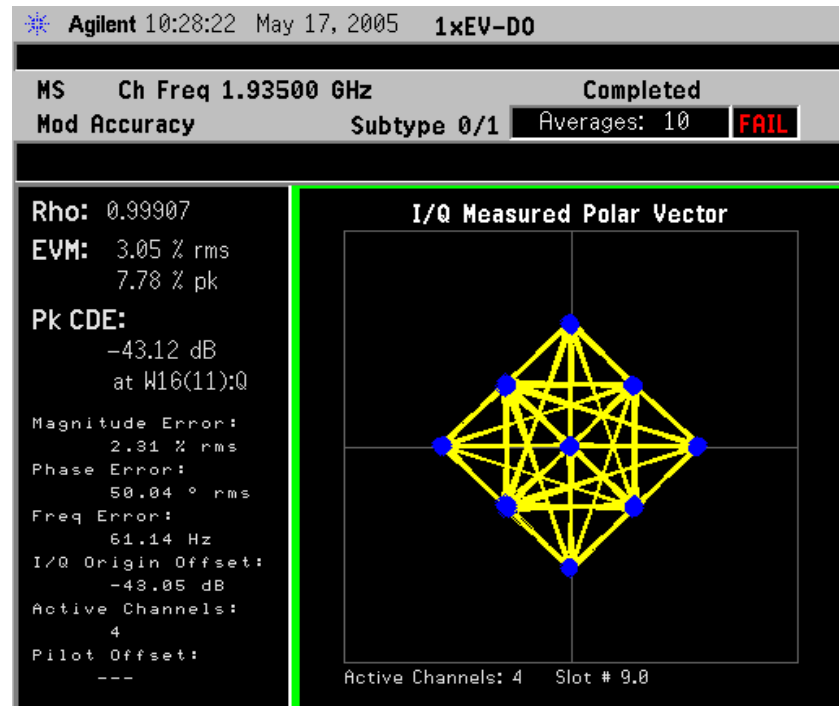
Key Reference  
1xEV-DO Measurement Keys

### View/Trace Key Menu

Key Path: Mod Accuracy (Composite Rho), View Trace

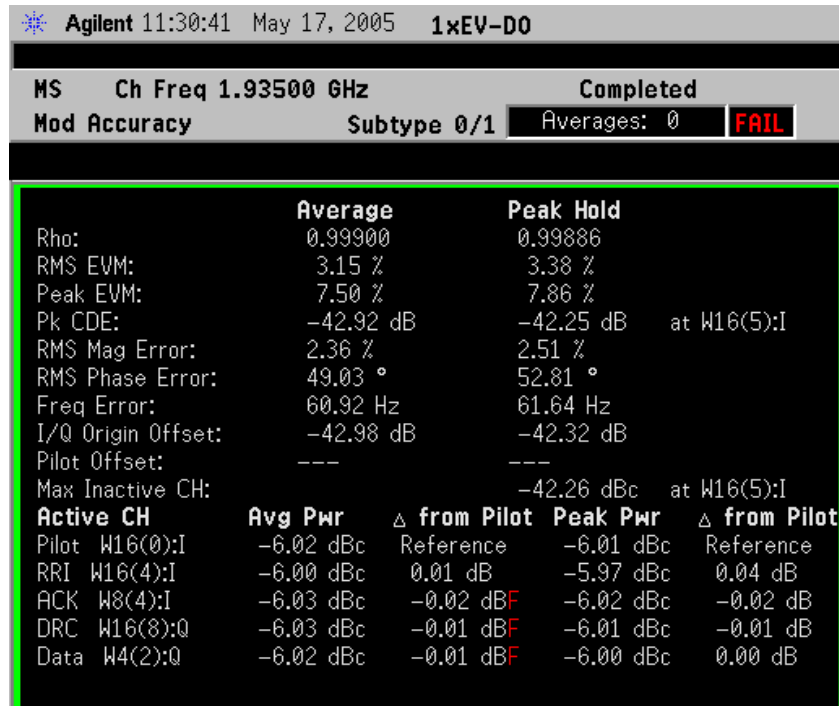
- **I/Q Measured Polar Graph** - Provides a combination view of an I/Q measured polar vector graph and the summary data as shown in [Figure 3-15](#).

**Figure 3-15** Modulation Accuracy Measurement - I/Q Polar Graph View



- **Peak/Avg Metrics** - Provides a text view of the measured result data for rho, EVM, peak code domain error, magnitude error, phase error, and so forth as shown in [Figure 3-16](#).

**Figure 3-16 Modulation Accuracy Measurement - Peak/Avg Metrics View**

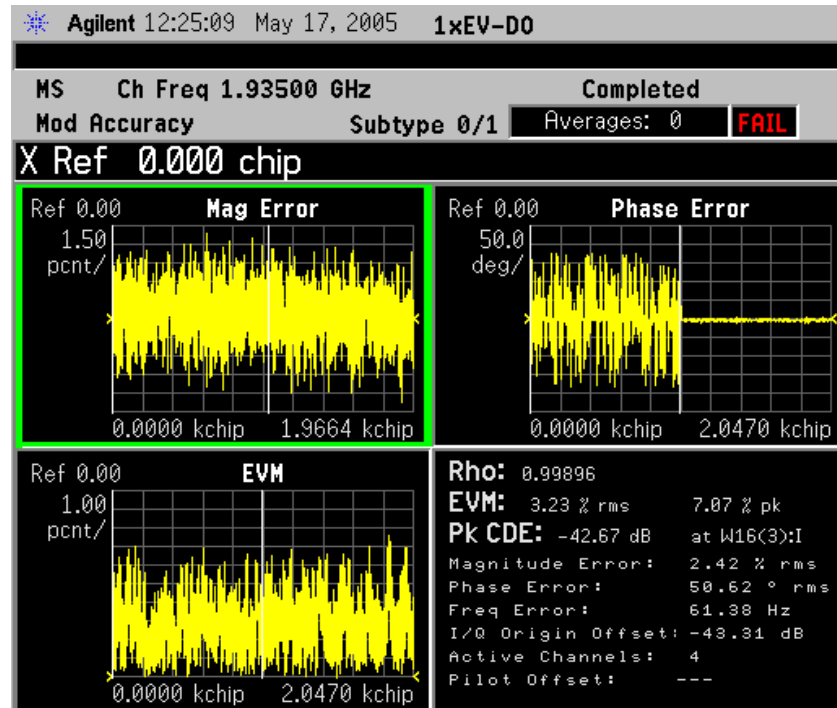


\*Meas Setup: View/Trace = Result Metrics,  
Others = Factory default settings

\*Input signal: -10.00 dBm, 1xEV-DO

- **I/Q Error (Quad-View)** - Four display windows show Mag Error, Phase Error, and EVM graphs, and the summary data for the composite rho, rms and peak EVM, peak code domain error with the code number, rms magnitude error, rms phase error, frequency error, and other parameters as shown in [Figure 3-17](#).

**Figure 3-17 Modulation Accuracy Measurement - I/Q Error Quad View**



\*Meas Setup: View/Trace = I/Q Error (Quad View),  
Others = Factory Default Settings

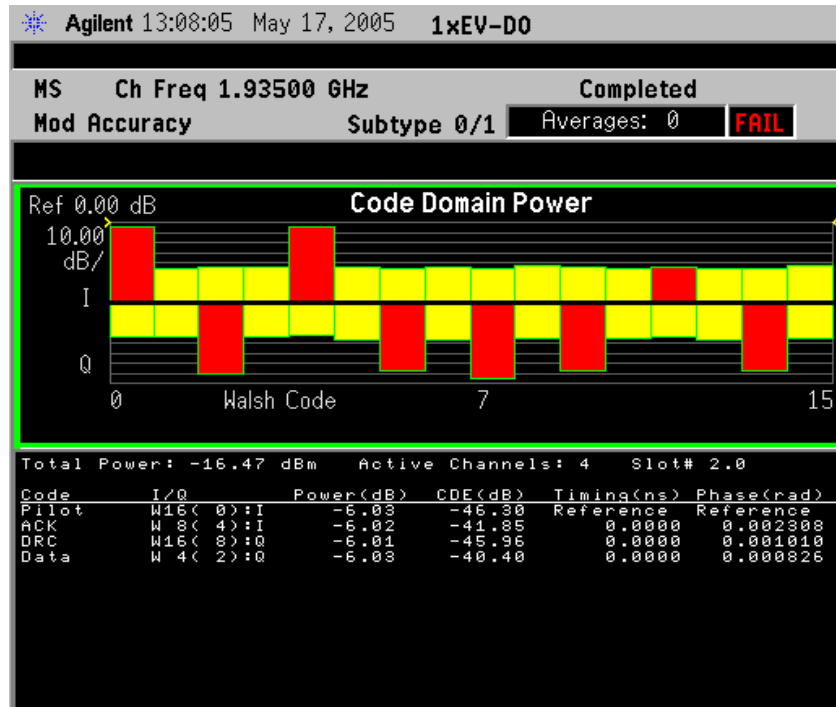
\*Input signal: 0.00 dBm, 1xEV-DO

Any one of these windows can be selected by the **Next Window** key  
and made full size using the **Zoom** key.



- **Code Domain Power**- Provides a measurement result of the active channels with power levels.

**Figure 3-18 Modulation Accuracy Measurement - Code Domain Power View**



\*Meas Setup: Advanced: Multi Channel Estimator = ON  
View/Trace = Power Timing & Phase,  
Others = Factory default settings

\*Input signal: -10.00 dBm, 1xEV-DO

### Display Key Menu

Key Path: **Mod Accuracy (Composite Rho), Display**

- **I/Q Polar Vec/Constln** - Allows you to access the menu of the following parameters:
  - **Vect & Constln** - Sets to display the I/Q polar graph with the vector trajectory traces and constellation spots.
  - **Vec** - Sets to display the I/Q polar graph with the vector trajectory traces.
  - **Constln** - Sets to display the I/Q polar graph with the constellation spots.
- **Chip Offset** - Allows you to specify the number of chips offset from the first chip in the captured slot to the first chip displayed for the I/Q waveforms. The range is 0 to 2048 chips. The sum of **Chip Offset** and **Chip Interval** should be equal to or less than 2048.

## Key Reference

## 1xEV-DO Measurement Keys

- **Chip Interval** - Allows you to specify the number of chips to be displayed from the chip number set by **Chip Offset** for I/Q waveforms. The range is 0 to 2048 chips. The sum of **Chip Offset** and **Chip Interval** should be equal to or less than 2048.
- **+45 deg Rot** - Allows you to toggle the display rotation function between **On** and **Off**. When this is set to **On**, the I/Q polar vector or constellation graph is rotated by +45 degrees to see a rectangular display. The default setting is **Off**. This key does not affect the **I/Q Error (Quad View)** display.
- **Full Vector (Background)** - Allows you to toggle the full vector display function between **On** and **Off**. When set to **On**, the full vector traces in gray color are displayed in the background of the polar vector solid traces in yellow. The default setting is **Off**. When **View/Trace** is set to **I/Q Measured Polar Constln**, this key is disabled. This key does not affect the **I/Q Error (Quad View)** display.

## NOTE

The following additional keys become active for **I/Q Error (Quad View)** view when either the EVM, Phase Error, or Mag Error window is active:

- **SPAN X Scale**
  - **Scale/Div** - Allows you to set the horizontal scale by changing a chip value per division. The range is 1.0 to 200.0 chips per division. The default setting is 153.5 chips per division. However, since the **Scale Coupling** default **On**, this value is automatically determined by the measurement result. When you set a value manually, **Scale Coupling** automatically changes to **Off**.
  - **Ref Value** - Allows you to set the chip reference value ranging from 0.0 to 2000.0 chips. The default setting is 0.0 chip. However, since the **Scale Coupling** default is **On**, this value is automatically determined by the measurement results. When you set a value manually, **Scale Coupling** automatically changes to **Off**.
  - **Ref Position** - Allows you to set the reference position to either **Left**, **Ctr** (center) or **Right**. The default setting is **Left**.
  - **Scale Coupling** - Allows you to toggle the scale coupling function between **On** and **Off**. The default setting is **On**. Upon pressing the **Restart** front panel key or the **Restart** softkey under the **Meas Control** menu, scale coupling automatically determines the scale per division and reference values based on the measurement results. When you set a value to either **Scale/Div** or **Ref Value** manually, **Scale Coupling** automatically changes to **Off**.

## NOTE

The following additional keys become active for **I/Q Error (Quad View)** view when either the EVM or Mag Error window is active:

- **AMPLITUDE Y Scale**

- **Scale/Div** - Allows you to set the vertical scale by changing the value per division. The range is 0.100 to 50.0% per division. The default setting is 5.00%. However, since the **Scale Coupling** default is **On**, this value is automatically determined by the measurement result. When you set a value manually, **Scale Coupling** automatically changes to **Off**.
- **Ref Value** - Allows you to set the reference value ranging from 0.00 to 500.0%. The default setting is 0.00%. However, since the **Scale Coupling** default is **On**, this value is automatically determined by the measurement results. When you set a value manually, **Scale Coupling** automatically changes to **Off**.
- **Ref Position** - Allows you to set the reference position to either **Top**, **Ctr** (center) or **Bot** (bottom). For the EVM graph, the default setting is **Bot**. For the Mag Error graph, the default setting is **Ctr**.
- **Scale Coupling** - Allows you to toggle the scale coupling function between **On** and **Off**. The default setting is **On**. Upon pressing the **Restart** front panel key or the **Restart** softkey under the **Meas Control** menu, scale coupling automatically determines the scale per division and reference values based on the measurement results. When you set a value to either **Scale/Div** or **Ref Value** manually, **Scale Coupling** automatically changes to **Off**.

---

**NOTE**

---

The following additional keys become active for **I/Q Error (Quad View)** view when the **Phase Error** window is active:

- **AMPLITUDE Y Scale**

- **Scale/Div** - Allows you to set the vertical scale by changing the value per division. The range is 0.01 to 3600.0 degrees. The default setting is 5.00 degrees per division. However, since the **Scale Coupling** default is **On**, this value is automatically determined by the measurement result. When you set a value manually, **Scale Coupling** automatically changes to **Off**.
- **Ref Value** - Allows you to set the reference value ranging from -36000 to 36000 degrees. The default setting is 0.00 degrees. However, since the **Scale Coupling** default is **On**, this value is automatically determined by the measurement results. When you set a value manually, **Scale Coupling** automatically changes to **Off**.
- **Ref Position** - Allows you to set the reference position to either **Top**, **Ctr** (center) or **Bot** (bottom). The default setting is **Ctr**.
- **Scale Coupling** - Allows you to toggle the scale coupling function between **On** and **Off**. The default setting is **On**. Upon pressing the **Restart** front panel key or the **Restart** softkey under the **Meas Control** menu, scale coupling automatically determines the scale per division and reference values based on the measurement results. When you set a value to either **Scale/Div** or **Ref Value**

manually, **Scale Coupling** automatically changes to **Off**.

### Marker Key Menu

Key Path: **Mod Accuracy (Composite Rho), Marker**

- **Select** - Allows you to activate up to four markers with the corresponding numbers, respectively. The selected number is underlined and its function is defined by pressing the **Function** key. The default setting is 1.
- **Normal** - Allows you to activate the selected marker to read the magnitude or phase error and the number of chips of the marker position on the selected trace, for example. Marker position is controlled by the RPG knob.
- **Delta** - Allows you to read the differences in the magnitude or phase errors and the number of chips between the selected marker and the next.
- **Function** - Allows you to set the selected marker function to **Band Power**, **Noise**, or **Off**. The default setting is **Off**. The **Band Power** and **Noise** functions are not available for this measurement.
- **Trace** - Allows you to place the selected marker on the **EVM**, **Phase Error**, **Mag Error**, or **CDP** trace. The default setting is **EVM**.
- **Off** - Allows you to turn off the selected marker.
- **Shape** - Allows you to access the menu to set the selected marker shape to **Diamond**, **Line**, **Square**, or **Cross**. The default setting is **Diamond**.
- **Marker All Off** - Allows you to turn off all of the markers.

### Troubleshooting Hints

A poor phase error often indicates a problem with the I/Q baseband generator, filters, and/or modulator in the transmitter circuitry of the UUT. The output amplifier in the transmitter can also create distortion that causes unacceptably high phase error. In a real system, a poor phase error will reduce the ability of a receiver to correctly demodulate the received signal, especially in marginal signal conditions.

### Occupied Bandwidth Keys

---

#### NOTE

Select key path: **MEASURE, Occupied BW** to access these menus.

---

### Meas Setup Key Menu

Key Path: **Occupied BW, Meas Setup**

- **Avg Number** - Allows you to change the number of N averages to be

made.

- **Avg Mode** - Allows you to toggle the averaging mode between **Exp** (exponential) and **Repeat**. This selection only effects on the averaging result after the number of N averages is reached. The N is set using the **Avg Number** key.
  - **Normal averaging:** Normal (linear) averaging is always used until the specified number of N averages is reached. When the **Measure** key under **Meas Control** is set to **Single**, data acquisition is stopped when the number of N averages is reached, thus **Avg Mode** has no effect in the single measurement mode.
  - **Exponential averaging:** When **Measure** is set to **Cont**, data acquisition will continue indefinitely. Exponential averaging is used with a weighting factor of N (the displayed count of averages stops at N). Exponential averaging weights new data more heavily than old data, which allows tracking of slow-changing signals. The weighting factor N is set using the **Avg Number** key.
  - **Repeat averaging:** When **Measure** is set to **Cont**, data acquisition will continue indefinitely. After the number of N averages is reached, all previous result data is cleared and the average count displayed is set back to 1. This is equivalent to being in **Measure Single** and pressing the **Restart** key each time the single measurement finishes.
- **Span** - Allows you to specify a value for the frequency span in which the total power is measured. The range is 10.000 kHz to 10.000 MHz with 1 Hz resolution.
- **Res BW** - Allows you to specify a value for the resolution bandwidth. The frequency range is 1.000 kHz to 1.00000 MHz. A narrower bandwidth will result in a longer data acquisition time but you will be able to examine the signal more closely.
- **Limit Test** - Allows you to toggle the limit test function between **On** and **Off**, for occupied bandwidth measurements.
- **Limit** - Allows you to specify a value for the limit frequency with which the limit test is made. The range is 10.000 kHz to 10.000 MHz with 1 Hz resolution.
- **Advanced** - Allows you to access the selection menu of FFT windows.
  - **FFT Window** - Allows you to access the following selection menu for FFT windows. When you are familiar with FFT windows, you can use other digital filters but the use of the flat top filter is recommended. Changes from the default setting may result in invalid data.
    - Flat Top** - Select this filter for best amplitude accuracy by reducing scalloping error.
    - Uniform** - Select this filter to have no active window.

## 1xEV-DO Measurement Keys

- Hanning** - Press this key to activate the Hanning filter.
- Hamming** - Press this key to activate the Hamming filter.
- Gaussian (Alpha 3.5)** - Press this key to activate the Gaussian filter with an alpha of 3.5.
- Blackman** - Press this key to activate the Blackman filter.
- Blackman-Harris** - Press this key to activate the Blackman-Harris filter.
- K-B 70dB, 90dB, 110dB (Kaiser-Bessel)** - Allows you to select one of the Kaiser-Bessel filters with sidelobes at -70, -90, or -110 dB.

Table 3-7

## Occupied Bandwidth Measurement Defaults

Measurement Parameter	Factory Default Condition
Meas Setup:	
Avg Number	10; On
Avg Mode	Repeat
Span	3.75000 MHz
Res BW	30.000 kHz
Trig Source	Free Run (Immediate)
Limit Test	On
Limit	1.48000 MHz
<b>Advanced</b>	
FFT Window	Gaussian (Alpha 3.5)

**View/Trace Key Menu**

The **View/Trace** key is not available for this measurement.

**Display Key Menu**

The **Display** key not available for this measurement.

**AMPLITUDE Y Scale Key Menu**

Key Path: **Occupied BW, AMPLITUDE Y Scale**

- **Scale/Div** - Allows you to enter a value to change the vertical display sensitivity. The range is 0.10 to 20.00 dB with 0.01 dB resolution. The default setting is 10.00 dB. However, since the **Scale Coupling** default is **On**, this value is automatically determined by the measurement result. When you set a value manually, **Scale Coupling** automatically changes to **Off**.
- **Ref Value** - Allows you to set a value for the absolute power reference. The range is from -250.00 to 250.00 dBm with 0.01 dB resolution.

The default setting is 10.00 dBm. However, since the **Scale Coupling** default is **On**, this value is automatically determined by the measurement result. When you set a value manually, **Scale Coupling** automatically changes to **Off**.

- **Ref Position** - Allows you to set the reference position to either **Top**, **Ctr** (center), or **Bot** (bottom). The default setting is **Top**.
- **Scale Coupling** - Allows you to toggle the scale coupling function between **On** and **Off**. The default setting is **On**. Upon pressing the **Restart** front panel key or the **Restart** softkey under the **Meas Control** menu, the scale coupling function automatically determines the scale per division and reference values based on the measurement results. When you set a value to either **Scale/Div** or **Ref Value** manually, **Scale Coupling** automatically changes to **Off**.

### Marker Key Menu

The **Marker** key is not available for this measurement.

### Troubleshooting Hints

Any distortion such as harmonics or intermodulation, for example, produces undesirable power outside the specified bandwidth.

Shoulders on either side of the spectrum shape indicate spectral regrowth and intermodulation. Rounding or sloping of the top shape can indicate filter shape problems.

### Power Stat CCDF Keys

---

**NOTE**

Select key path: **MEASURE, Power Stat CCDF** to access these menus.

### Meas Setup Key Menu

Key Path: **Power Stat CCDF, Meas Setup**

- **Meas BW** - Allows you to set the measurement bandwidth according to the channel bandwidth. The range is 10.000 kHz to 6.70000 MHz with 0.1 kHz resolution.
- **Counts** - Allows you to set the accumulated number of sampling points for data acquisition. The range is 1.000 kpoints to 2.000 Gpoints with 1 or 10 kpoints resolution. While this key is activated, enter a value from the numeric keypad by terminating with one of the unit keys shown.
- **Meas Interval** - Allows you to specify the time interval over which the measurement is made. The range is 100.0  $\mu$ s to 10.00 ms with 1  $\mu$ s resolution.

[Table 3-8](#) shows the factory default settings for power statistics CCDF

measurements.

**Table 3-8 Power Statistics CCDF Measurement Defaults**

Measurement Parameter	Factory Default Condition
Meas Setup:	
Meas BW	5.00000 MHz
Counts	10.0000 Mpoints
Meas Interval	1.000 ms
Trig Source	Free Run (Immediate)
Meas Control:	
Measure	Single
Display:	
Ref Trace	Off
Gaussian Line	On

### View/Trace Key Menu

The **View /Trace** key is not available for this measurement

### Display Key Menu

Key Path: **Power Stat CCDF, Display**

- **Store Ref Trace** - Allows you to copy the currently measured curve as the user-definable reference trace. The captured data will remain until the other mode is chosen. Pressing this key refreshes the reference trace.
- **Ref Trace** - Allows you to toggle the reference trace display function between **On** and **Off**.
- **Gaussian Line** - Allows you to toggle the Gaussian line display function between **On** and **Off**.

### SPAN X Scale Key Menu

Key Path: **Power Stat CCDF, SPAN X Scale**

- **Scale/Div** - Allows you to enter a numeric value to change the horizontal display sensitivity. The range is 0.10 to 20.00 dB with 0.01 dB resolution. The default setting is 2.00 dB.

### Marker Key Menu

Key Path: **Power Stat CCDF, Marker**

- **Select 1 2 3 4** - Allows you to activate up to four markers with the



corresponding numbers, respectively. The selected number is underlined and its function is defined by pressing the **Function** key. The default selection is 1.

- **Normal** - Allows you to activate the selected marker to read the power level and probability of the marker position on the selected curve. Marker position is controlled by the RPG knob.
- **Delta** - Allows you to read the differences in the power levels and probabilities between the selected marker and the next.
- **Function** - Allows you to set the selected marker function to **Band Power**, **Noise**, or **Off**. The default setting is **Off**. The **Band Power** and **Noise** functions are not available for this measurement.
- **Trace** - Allows you to place the selected marker on the **Measured**, **Gaussian**, or **Reference** curve. The default setting is **Measured**.
- **Off** - Allows you to turn off the selected marker.
- **Shape** - Allows you to access the menu to set the selected marker shape to **Diamond**, **Line**, **Square**, or **Cross**. The default setting is **Diamond**.
- **Marker All Off** - Allows you to turn off all of the markers.

### Troubleshooting Hints

The power statistics CCDF measurement can help in determining the signal power specifications used as design criteria for systems, amplifiers, and other components. For example, it can help determine the optimum operating point to adjust code timing for appropriate peak/average power ratio throughout the wide channel bandwidth of the transmitter for a 1xEV-DO system.

As this measurement becomes more widely used the correlation between CCDF curve degradation and digital radio system measurement parameters such as BER, FER, code domain power, and ACPR will become more established. Further studies will eventually yield standards for radio design by specifying the maximum allowed CCDF curve degradation for specific systems.

As this measurement becomes more widely used the correlation between CCDF curve degradation and digital radio system measurement parameters such as BER, FER, code domain power, and ACPR will become more established. Further studies will eventually yield standards for radio design by specifying the maximum allowed CCDF curve degradation for specific systems.

### Power Versus Time Keys (Radio Device = BTS only)

---

**NOTE**

Select key path: **MEASURE, Power vs Time** to access these menus.

## Meas Setup Key Menu

Key Path: **Power vs Time, Meas Setup**

- **Avg Bursts** - Allows you to define how many burst signals will be averaged to calculate the average power.
- **Avg Mode** - Allows you to toggle the averaging mode between **Exp** (exponential) and **Repeat**. This selection only effects on the averaging result after the number of N averages is reached. The N is set using the **Avg Number** key.
  - **Exp** - When **Measure** is set to **Cont**, data acquisition will continue indefinitely. Exponential averaging is used with a weighting factor of N (the displayed count of averages stops at N). Exponential averaging weights new data more heavily than old data, which allows tracking of slow-changing signals. The weighting factor N is set using the Avg Number key.
  - **Repeat** - When **Measure** is set to **Cont**, data acquisition will continue indefinitely. After the number of N averages is reached, all previous result data is cleared and the average count displayed is set back to 1. This is equivalent to being in **Measure Single** and pressing the **Restart** key each time the single measurement finishes.
- **Avg Type** - Allows you to access the menu of the following average types:
  - **Pwr Avg (RMS)** - Executes the true power averaging which is equivalent to taking the rms of the voltage. This is the most accurate type.
  - **Log-Pwr Avg (Video)** - Simulates the traditional spectrum analyzer type of averaging by calculating the log of the power.
  - **Voltage Avg** - Executes the voltage averaging.
  - **Maximum** - Executes the maximum voltage averaging by capturing peak data.
  - **Minimum** - Executes the minimum voltage averaging.
- **Slot Type** - Allows you to access the menu to select either of the following slots:
  - **Idle Slot** - Allows you to measure the burst power waveform of the Pilot and MAC channels with the masks in all regions.
  - **Active Slot** - Allows you to measure the total power waveform of Pilot, Mac, and Data channels with the upper and lower masks for one half slot interval of 1024 chips or 833.3 ms.
- **Trig Source** - Allows you to select one of the trigger sources: **Ext Front**, **Ext Rear**, and **Frame**.

- **Region/Limits** - Allows you to access the menu to change the following parameters for offset time settings and power level masks:
  - **Region** - Allows you to access the memory selection menu from **A** to **E** to store 5 sets of values for **Offset Start**, **Offset Stop**, **Interval**, **Upper Mask**, **Lower Mask**, and **Power Ref**, respectively. Only one memory selection at a time (A, B, C, D, or E) is shown on this key. This key is not available when **Slot Type** is set to **Active Slot**.
  - **Offset Start** - Allows you to enter a value for the offset start of a region. The range is  $-1000.00\ \mu\text{s}$  to  $+1000.00\ \mu\text{s}$ , or  $-1000$  chips to  $+1000$  chips. While this key is activated, enter an offset value from the numeric keypad by terminating with one of the unit keys shown. One offset value selected in the **Region** menu is shown on this key. This key is not available when **Slot Type** is set to **Active Slot**.
  - **Offset Stop** - Allows you to enter a value for the offset stop of a region. The range is  $-1000.00\ \mu\text{s}$  to  $+1000.00\ \mu\text{s}$ , or  $-1000$  chips to  $+1000$  chips. While this key is activated, enter an offset value from the numeric keypad by terminating with one of the unit keys shown. When you set a value to **Interval**, **Offset Stop** is automatically determined based on the offset start and interval values, as **Offset Stop** and **Interval** are coupled each other. One offset value selected in the **Region** menu is shown on this key. This key is not available when **Slot Type** is set to **Active Slot**.
  - **Interval** - Allows you to enter an interval value between Offset Start and Offset Stop. The range is  $-1000.00\ \mu\text{s}$  to  $+1000.00\ \mu\text{s}$ , or  $-1000$  to  $+1000$  chips. While this key is activated, enter an interval value from the numeric keypad by terminating with one of the unit keys shown.
  - **Upper Mask** - Allows you to enter a relative limit value for the upper mask, and to toggle the mask function between **On** and **Off**. The range is from  $-100.00$  to  $+50.00$  dB with 0.01 dB resolution.
  - **Lower Mask** - Allows you to enter a relative limit value for the lower mask, and to toggle the mask function between **On** and **Off**. The range is from  $-100.00$  to  $+50.00$  dBm with 0.01 dB resolution.
  - **Power Ref** - Allows you to toggle the power reference function between **On** and **Off**. You can set only one region out of 5 regions to **On**, and the rest of regions are automatically set to **Off**. This key is not available when **Slot Type** is set to **Active Slot**.
- **Power Reference** - Allows you to access the following menu to select one of the power references to make measurements:
  - **Region A to Region E** - Allows you to set the power reference to **Region A** through **Region E** to make relative power measurements.
- **Time Reference** - Allows you to access the following menu to select

Key Reference  
1xEV-DO Measurement Keys

one of the time references to make measurements:

- **Burst Rise** - Allows you to set the time reference to the rising edge of bursts.
- **Burst Center** - Allows you to set the time reference to the center of burst length.
- **Trigger** - Allows you to set the time reference to the trigger point.
- **Burst Search Threshold** - Allows you to set a value of relative power level from the averaged power-on reference. This value is used to determine the rising and falling edges. The range is from -100.00 to 0.00 dB.
- **Advanced** - Allows you to access the menu to set the following parameters:
  - **RBW Filter** - Allows you to toggle the filter function between **Gaussian** and **Flat**.
  - **Res BW** - Allows you to enter a value for the resolution bandwidth. The range is from 1.000 kHz to 7.500 MHz.
  - **Burst Slope Threshold** - Allows you to enter a value for the power level change in  $\mu\text{s}$ . This will assure you to detect steep enough slopes in conjunction with **Burst Slope Detect Intvl**. The range is from 0.1 dB/ $\mu\text{s}$  to 10.0 dB/ $\mu\text{s}$ .
  - **Burst Slope Detect Intvl** - Allows you to enter a number of chips within which the slope power level changes are integrated for mathematically deriving an averaged slope. When this slope is steeper than the slope threshold level, this slope is detected as the valid one. When not, this slope is not used to detect an edge. The range is from 0.5 chips to 3.0 chips in 0.1 chips.
  - **Time Ref Offset** - Allows you to enter a value for the time reference offset. This value is used to make a fine timing adjustment from the time reference identified. The range is from -10.0 ms to +10.00 ms.

Table 3-9 shows the factory default settings for power versus time measurements.

Table 3-9 Power versus Time Measurement Defaults

Measurement Parameter	Factory Default Condition
View/Trace	Burst
Avg Bursts	100; On
Avg Mode	Repeat
Avg Type	Pwr Avg (RMS)

**Table 3-9 Power versus Time Measurement Defaults**

<b>Measurement Parameter</b>	<b>Factory Default Condition</b>
Slot Type	Idle Slot (Pilot + MAC)
Trig Source	Frame
Region/Limits:	
Region	A
Offset Start	-416.67 $\mu$ s
Offset Stop	-97.33 $\mu$ s
Interval	319.34 $\mu$ s
Upper Mask	-7.00 dB; On
Lower Mask	-100.00 dB; Off
Power Reference	Region C
Time Reference	Burst Center
Burst Search Threshold	-10.00 dB
<b>Advanced</b>	
RBW Filter	Flat
Res BW	1.500 MHz
Burst Slope Threshold	2.0 dB/ $\mu$ s
Burst Slope Detect Intvl	2.0 chips (interpolated slope)
Time Ref Offset	0 s

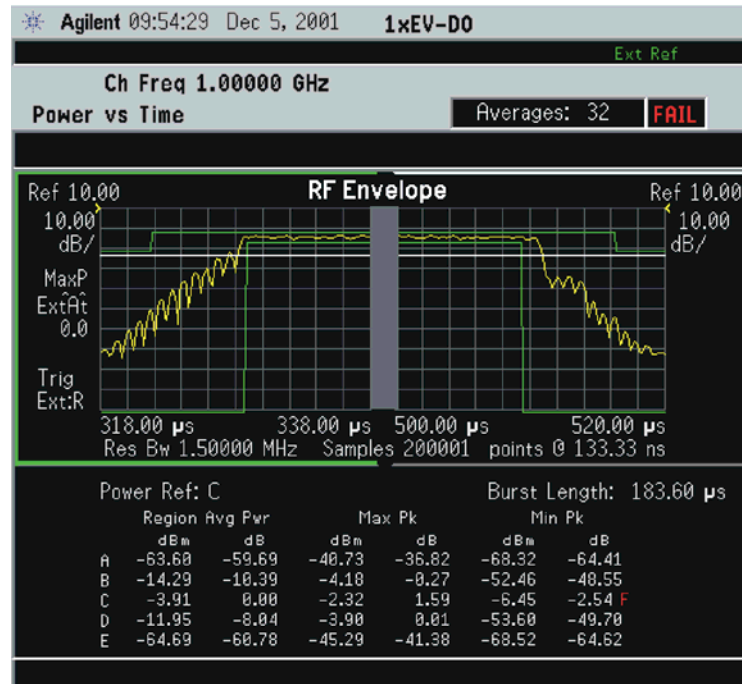
Key Reference  
1xEV-DO Measurement Keys

### View/Trace Key Menu

Key Path: **Power vs Time, View/Trace**

- **Rise & Fall** - Displays both the rising edge and the falling edge regions expanded in the horizontal scale, and lists the values of average power, maximum peak power, and minimum peak power for each region. **Figure 3-19** shows an example of the rise & fall view.

**Figure 3-19** Power vs. Time Measurement - Rise & Fall View



\*Tester: View/Trace = Rise & Fall,  
Others = Factory default settings

\*Input signal: -10.00 dBm, Idle slot, 1xEV-DO

#### NOTE

While in this view, you can change the vertical scale by pressing the **AMPLITUDE Y Scale** key. You can also activate or deactivate the reference bandwidth markers by pressing the **Display** key.

- **Region A through Region E** - Displays each region from A through E in the full horizontal scale.

### Display Key Menu

Key Path: **Power vs Time, Display**

- **Limit Mask** - Toggles the limit mask display function between **On** and **Off**. When set to **On**, the limit mask is displayed on the screen.
- **Burst Search Thrshld Line** - Toggles the display function of the burst search threshold line between **On** and **Off**. When set to **On**, the burst

search threshold line is displayed on the screen.

- **SPAN X Scale**

- **Scale/Div** - Allows you to enter a numeric value to change the horizontal display sensitivity. The range is 1.00 ns to 1.00 s. The default setting is 100.00  $\mu$ s. However, since the **Scale Coupling** default is **On**, this value is automatically determined by the measurement result. When you set a value manually, **Scale Coupling** automatically changes to **Off**.
- **Ref Value** - Allows you to set a value for the relative time reference. The range is from -1.00 s to 10.00 s. The default setting is 0.00 s. However, since the **Scale Coupling** default is **On**, this value is automatically determined by the measurement result. When you set a value manually, **Scale Coupling** automatically changes to **Off**.
- **Ref Position** - Allows you to set the reference position to either **Top**, **Ctr** (center), or **Bot** (bottom). The default setting is **Left**.
- **Scale Coupling** - Allows you to toggle the scale coupling function between **On** and **Off**. The default setting is **On**. Upon pressing the **Restart** front panel key or **Restart** softkey under the **Meas Control** menu, the scale coupling function automatically determines the scale per division and reference values based on the measurement results. When you set a value to either **Scale/Div** or **Ref Value** manually, **Scale Coupling** automatically changes to **Off**.

- **AMPLITUDE Y Scale**

- **Scale/Div** - Allows you to enter a numeric value to change the vertical display sensitivity. The range is 0.10 to 20.00 dB with 0.01 dB resolution. The default setting is 10.00 dB. However, since the **Scale Coupling** default is **On**, this value is automatically determined by the measurement result. When you set a value manually, **Scale Coupling** automatically changes to **Off**.
- **Ref Value** - Allows you to set a value for the absolute power reference. The range is from -250.00 to 250.00 dBm with 0.01 dB resolution. The default setting is 10.00 dBm. However, since the **Scale Coupling** default is **On**, this value is automatically determined by the measurement result. When you set a value manually, **Scale Coupling** automatically changes to **Off**.
- **Ref Position** - Allows you to set the reference position to either **Top**, **Ctr** (center), or **Bot** (bottom). The default setting is **Top**.
- **Scale Coupling** - Allows you to toggle the scale coupling function between **On** and **Off**. The default setting is **On**. Upon pressing the **Restart** front panel key or **Restart** softkey under the **Meas Control** menu, the scale coupling function automatically determines the scale per division and reference values based on the measurement

results. When you set a value to either **Scale/Div** or **Ref Value** manually, **Scale Coupling** automatically changes to **Off**.

### Marker Key Menu

The **Marker** key is not available for this measurement.

### Troubleshooting Hints

This power versus time measurement can reveal degraded or defective parts in the transmitter section of the UUT. The following examples are those areas to be checked further.

- Some faults in the DC power supply control of the transmitter power amplifier, RF power controller of the pre-power amplifier stage, or I/Q control of the baseband stage
- Some degradation in the gain and output power level of the amplifier due to the degraded gain control and/or increased distortion
- Some degradation of the amplifier linearity and other performance characteristics

Power amplifiers are one of the final stage elements of a base or mobile transmitter and are a critical part of meeting the important power and spectral efficiency specifications. Since PvT measures the time domain response of the amplifier to a complex wideband signal, it is a key measurement linking amplifier linearity and other performance characteristics to the stringent system specifications.

### QPSK EVM Keys (Radio Device = BTS only)

---

#### NOTE

Select key path: **MEASURE, QPSK EVM** to access these menus.

---

### Meas Setup Key Menu

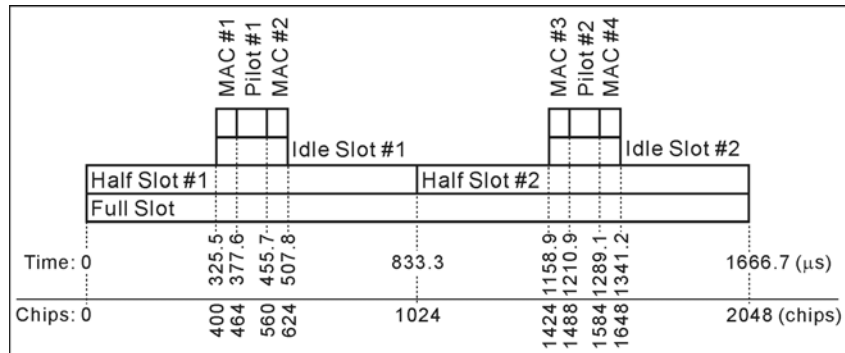
Key Path: **QPSK EVM, Meas Setup**

- **Avg Number** - Allows you to change the number of N averages to be made.
- **Avg Mode** - Allows you to toggle the averaging mode between **Exp** (exponential) and **Repeat**. This selection only effects on the averaging result after the number of N averages is reached. The N is set using the **Avg Number** key.
  - **Normal averaging:** Normal (linear) averaging is always used until the specified number of N averages is reached. When the **Measure** key under **Meas Control** is set to **Single**, data acquisition is stopped when the number of N averages is reached, thus **Avg Mode** has no effect in the single measurement mode.



- **Exponential averaging:** When **Measure** is set to **Cont**, data acquisition will continue indefinitely. Exponential averaging is used with a weighting factor of N (the displayed count of averages stops at N). Exponential averaging weights new data more heavily than old data, which allows tracking of slow-changing signals. The weighting factor N is set using the **Avg Number** key.
- **Repeat averaging:** When **Measure** is set to **Cont**, data acquisition will continue indefinitely. After the number of N averages is reached, all previous result data is cleared and the average count displayed is set back to 1. This is equivalent to being in **Measure Single** and pressing the **Restart** key each time the single measurement finishes.
- **Meas Offset & Interval** - Allows you to access the menus to set the offset and time interval over which the measurement is made.
  - **Meas Offset** - Allows you to set a value for the measurement offset in either  $\mu\text{s}$  or chips. When you enter a numeric value, the unit selection menu is shown. The range is from 17.9 to 1667.0  $\mu\text{s}$ , or 22 to 2048 chips.
  - **Meas Interval** - Allows you to set a value for the measurement interval in either  $\mu\text{s}$  or chips. When you enter a numeric value, the unit selection menu is shown. The range is from 26.0 to 1667.0  $\mu\text{s}$ , or 32 to 2048 chips.
  - **Pre-Defined Ofs/Intvl** - Allows you to select one of the following predefined channels or slots. The default selection is **Pilot #1** that is shown on this key. When you enter a value in either **Meas Offset** or **Meas Interval**, “-----” is shown. The channel and slot definitions are summarized in the illustration and table below.
    - Pilot** - Allows you to set either **Pilot #1** or **#2** of pilot channel as the preset measurement offset and interval.
    - MAC** - Allows you to set either **MAC #1**, **#2**, **#3**, or **#4** of medium access control (MAC) channel as the preset measurement offset and interval.
    - Idle Slot** - Allows you to set either **Idle Slot #1** or **#2** of idle slot as

the preset measurement offset and interval.



Selection	Meas Offset		Meas Interval	
	Time (μs)	Chips	Time (μs)	Chips
Pilot #1	377.6	464	78.1	96
Pilot #2	1210.9	1488	78.1	96
MAC #1	325.5	400	52.1	64
MAC #2	455.7	560	52.1	64
MAC #3	1158.9	1424	52.1	64
MAC #4	1289.1	1584	52.1	64
Idle Slot #1	325.5	400	182.3	224
Idle Slot #2	1158.9	1424	182.3	224

- **Advanced** - Allows you to access the menu to change the following parameters:
  - **Chip Rate** - Allows you to change the chip rate. The range is 1.10592 to 1.35168 MHz for SR1.
  - **ADC Range** - Allows you to access the following selection menu to define one of the ADC ranging functions:
    - Auto** - Select this to set the ADC range automatically. For most FFT measurements, the auto feature should not be selected. An exception is when measuring a “bursty” signal, in which case **Auto** can maximize the time domain dynamic range, when FFT results are less important to you than time domain results.
    - Auto Peak** - Select this to set the ADC range automatically to the peak signal level. **Auto Peak** is a compromise that works well for both CW and burst signals.
    - Auto Peak Lock** - Select this to hold the ADC range automatically at the peak signal level. **Auto Peak Lock** is more

stable than **Auto Peak** for CW signals, but should not be used for “bursty” signals.

- ❑ **Manual** - Allows you to access the selection menu of values, -6 dB to +24 dB for E4406A or None to +18 dB for PSA, to set the ADC range level. Also note that manual ranging is best for CW signals.

Table 3-10 shows the factory default settings for QPSK EVM measurements.

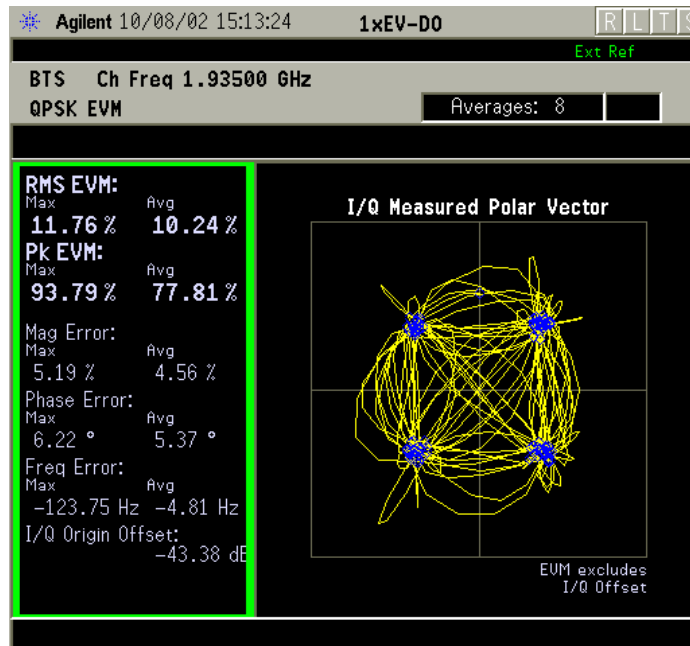
**Table 3-10** QPSK EVM Measurement Defaults

Measurement Parameter	Factory Default Condition
View/Trace	I/Q Measured Polar Vector
Display:	
I/Q Points	1280
Chip Dots	On
Meas Setup:	
Avg Number	10; On
Avg Mode	Repeat
Meas Offset & Interval	
Meas Offset:	464.0 chips (377.6 $\mu$ s)
Meas Interval:	96.0 chips (78.1 $\mu$ s)
Pre-Defined Ofs/Intvl:	Pilot #1
Limits	RMS EVM 50.0 pcnt
Trig Source	Ext Front
<b>Advanced</b>	
Chip Rate:	1.22880 MHz
ADC Range:	
Manual	-6 dB (for E4406A), None (for PSA)

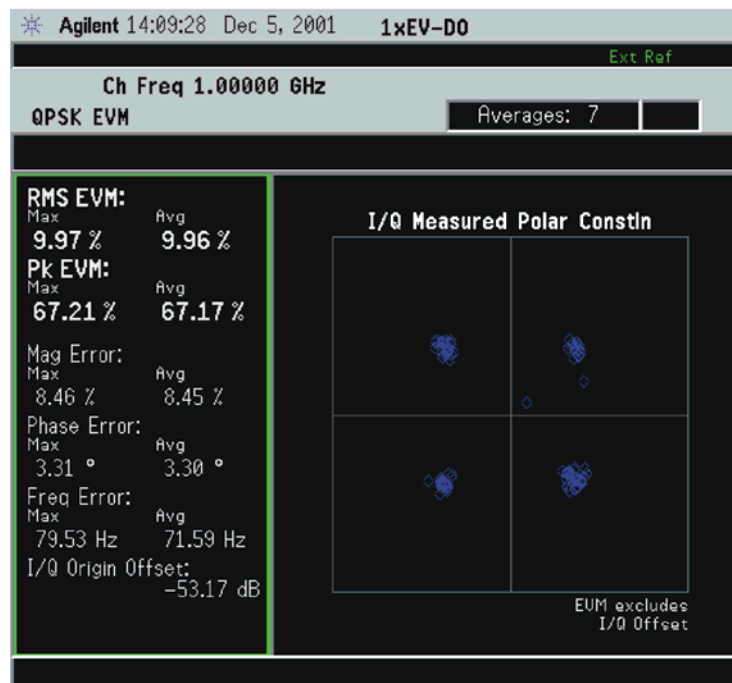
**View/Trace Key Menu**

Key Path: **QPSK EVM, View/Trace**

- **I/Q Measured Polar Vector** - Provides a combination view of an I/Q measured polar vector graph and the maximum and average summary data as shown in [Figure 3-20](#).

**Figure 3-20 QPSK EVM Measurement - I/Q Polar Vector View**

- **I/Q Measured Polar Constln** - Provides a combination view of an I/Q measured polar constellation graph and the maximum and average summary data for the rms EVM, peak EVM, magnitude error, phase error, frequency error, and so forth in the text window as shown in [Figure 3-21](#).

**Figure 3-21 QPSK EVM Measurement - I/Q Polar Constellation View**

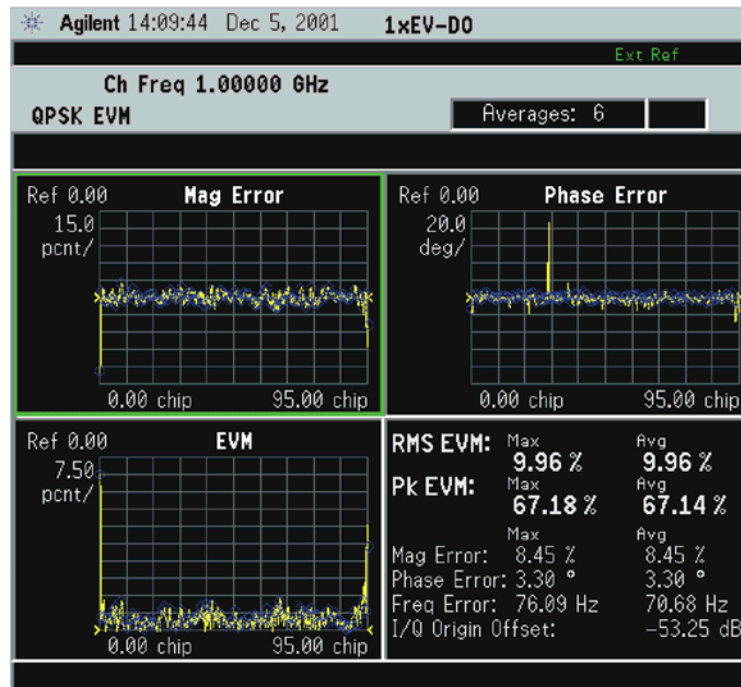
\*Meas Setup: View/Trace = I/Q Measured Polar Constln,  
Others = Factory default settings

\*Input signal: -10.00 dBm, Pilot channel, 1xEV-DO

- **I/Q Error (Quad View)** - Four display windows show Mag Error, Phase Error and EVM graphs, and the maximum and average summary data for the rms EVM, peak EVM, magnitude error, phase error, frequency error, and so forth in the text window as shown in [Figure 3-22](#).

Figure 3-22

**QPSK EVM Measurement - I/Q Error Quad View**



\*Meas Setup: View/Trace = I/Q Error (Quad View),  
Others = Factory default settings

\*Input signal: -10.00 dBm, Pilot channel, 1xEV-DO

Any of these windows can be selected using the **Next Window** key and made full size using the **Zoom** key.

**Display Key Menu**

Key Path: **QPSK EVM, Display**

- **I/Q Points** - Allows you to specify the number of displayed points for the I/Q waveforms. The range is 1 to 2560 points with the points per chip fixed at 5, depending on the **Meas Interval** setting. This key has no affect on the **I/Q Error (Quad View)** display.
- **Chip Dots** - Allows you to toggle the chip dot display between **On** and **Off**. When set to **On**, the chip dots in yellow are overlaid on the I/Q

polar graph. When **View/Trace** is set to **I/Q Measured Polar ConstIn**, this key is disabled.

---

**NOTE**

---

The following additional keys become active for **I/Q Error (Quad View)** view when either the EVM, Phase Error, or Mag Error window is active:

- **SPAN X Scale**

- **Scale/Div** - Allows you to set the horizontal scale by changing a chip value per division. The range is 1.0 to 128.0 chips per division. The default setting is 25.50 chips per division. However, since the **Scale Coupling** default is **On**, this value is automatically determined by the measurement result. When you set a value manually, **Scale Coupling** automatically changes to **Off**.
- **Ref Value** - Allows you to set the chip reference value ranging from 0.0 to 1280.0 chips. The default setting is 0.0 chips. However, since the **Scale Coupling** default is **On**, this value is automatically determined by the measurement results. When you set a value manually, **Scale Coupling** automatically changes to **Off**.
- **Ref Position** - Allows you to set the reference position to either **Left**, **Ctr** (center) or **Right**. The default setting is **Left**.
- **Scale Coupling** - Allows you to toggle the scale coupling function between **On** and **Off**. The default setting is **On**. Upon pressing the **Restart** front panel key or the **Restart** softkey under the **Meas Control** menu, the scale coupling function automatically determines the scale per division and reference values based on the measurement results. When you set a value to either **Scale/Div** or **Ref Value** manually, **Scale Coupling** automatically changes to **Off**.

---

**NOTE**

---

The following additional keys become active for **I/Q Error (Quad View)** view when either the EVM or Mag Error window is active:

- **AMPLITUDE Y Scale**

- **Scale/Div** - Allows you to set the vertical scale by changing the value per division. The range is 0.100 to 50.0% per division. The default setting is 5.00%. However, since the **Scale Coupling** default is **On**, this value is automatically determined by the measurement result. When you set a value manually, **Scale Coupling** automatically changes to **Off**.
- **Ref Value** - Allows you to set the reference value ranging from 0.00 to 500.0%. The default setting is 0.00%. However, since the **Scale Coupling** default is **On**, this value is automatically determined by the measurement results. When you set a value manually, **Scale Coupling** automatically changes to **Off**.
- **Ref Position** - Allows you to set the reference position to either **Top**,

**Ctr** (center) or **Bot** (bottom). For the EVM graph, the default setting is **Bot**. For the Mag Error graph, the default setting is **Ctr**.

- **Scale Coupling** - Allows you to toggle the scale coupling function between **On** and **Off**. The default setting is **On**. Upon pressing the **Restart** front panel key or the **Restart** softkey under the **Meas Control** menu, the scale coupling function automatically determines the scale per division and reference values based on the measurement results. When you set a value to either **Scale/Div** or **Ref Value** manually, **Scale Coupling** automatically changes to **Off**.

---

**NOTE**

---

The following additional keys become active for **I/Q Error (Quad View)** view when the Phase Error window is active:

- **AMPLITUDE Y Scale**

- **Scale/Div** - Allows you to set the vertical scale by changing the value per division. The range is 0.01 to 3600 degrees. The default setting is 0.10 degrees per division. However, since the **Scale Coupling** default is **On**, this value is automatically determined by the measurement result. When you set a value manually, **Scale Coupling** automatically changes to **Off**.
- **Ref Value** - Allows you to set the reference value ranging from -36000 to 36000 degrees. The default setting is 0.00 degrees. However, since the **Scale Coupling** default is **On**, this value is automatically determined by the measurement results. When you set a value manually, **Scale Coupling** automatically changes to **Off**.
- **Ref Position** - Allows you to set the reference position to either **Top**, **Ctr** (center) or **Bot** (bottom). The default setting is **Ctr**.
- **Scale Coupling** - Allows you to toggle the scale coupling function between **On** and **Off**. The default setting is **On**. Upon pressing the **Restart** front panel key or the **Restart** softkey under the **Meas Control** menu, the scale coupling function automatically determines the scale per division and reference values based on the measurement results. When you set a value to either **Scale/Div** or **Ref Value** manually, **Scale Coupling** automatically changes to **Off**.

### Marker Key Menu

Key Path: **QPSK EVM, Marker**

- **Select** - Allows you to activate up to four markers with the corresponding numbers, respectively. The selected number is underlined and its function is defined by pressing the **Function** key. The default setting is 1.
- **Normal** - Allows you to activate the selected marker to read the

magnitude or phase error and the number of chips of the marker position on the selected trace, for example. Marker position is controlled by the RPG knob.

- **Delta** - Allows you to read the differences in the magnitude or phase errors and the number of chips between the selected marker and the next.
- **Function** - Allows you to set the selected marker function to **Band Power**, **Noise**, or **Off**. The default setting is **Off**. The **Band Power** and **Noise** functions are not available for this measurement.
- **Trace** - Allows you to place the selected marker on the **EVM**, **Phase Error**, or **Mag Error** trace. The default setting is **EVM**.
- **Off** - Allows you to turn off the selected marker.
- **Shape** - Allows you to access the menu to set the selected marker shape to **Diamond**, **Line**, **Square**, or **Cross**. The default setting is **Diamond**.
- **Marker All Off** - Allows you to turn off all of the markers.

### Troubleshooting Hints

A poor phase error indicates a problem with the I/Q baseband generator, filters, and/or modulator in the transmitter circuitry of the UUT. The output amplifier in the transmitter can also create distortion that causes unacceptably high phase error. In a real system, a poor phase error will reduce the ability of a receiver to correctly demodulate the received signal, especially in marginal signal conditions.



## Spectrum (Frequency Domain) Keys

**NOTE** You must have selected **Spectrum** under the **MEASURE** menu to access these menus

### Meas Setup Key Menu

Key Path: **Meas Setup**

- **Span** - Modifies the frequency span. The range is 10 Hz to 10 MHz with 1 Hz resolution, depending on the **Res BW** setting. Changing the span causes the resolution bandwidth to change automatically, and will affect data acquisition time. For PSA Option 122 wideband operation, the maximum span is 80 MHz. For PSA Option 140 wideband operation, the maximum span is 40 MHz.
- **Res BW** - Sets the resolution bandwidth for the FFT, and to toggle its mode between **Auto** and **Man** (manual). If set to **Auto**, the resolution bandwidth is set to **Span/50** (2% of the span). If set to **Man**, you can enter a value ranging from 100.0 mHz to 3.00000 MHz. A narrower bandwidth will result in a longer data acquisition time.
- **Wideband IF Setup** (PSA Options 122 and 140 only.) configures the wideband hardware path..
  - **Wideband IF Gain** - Sets the gain for the wideband IF path in 2 dB steps from -12 to +12 dB. You must have selected **IF Path Wide**. Increasing the gain can increase the amplitude of small signals as long as you don't overdrive the hardware. Wideband gain should usually be adjusted after setting the input attenuation.
  - **Wideband Filtering** - Accesses the keys to configure the optional channel filter. The default is no filtering.
    - Filter Type** - Selects **None** for no filtering, or **Raised Cosine**, **RRC** (root-raised cosine), **Nyquist**, **Root Nyquist**, and **Gaussian**.
    - Filter Alpha** - Selects the filter alpha.
    - Filter BW** - Selects filter bandwidth. Bandwidth is not entered as a frequency. The value is entered as a ratio of the current instrument sampling rate (i.e. BW/sample rate).
  - **Wideband Advanced** - These keys are only for the PSA Option 122 or 140 in wideband operation. Accesses the advanced settings for the wideband IF hardware path.

**NOTE** Parameters under the **Wideband Advanced** key seldom need to be changed. Any changes from the default advanced values may result in invalid measurement data.

Key Reference  
1xEV-DO Measurement Keys

- ❑ **ADC Corr** Turning corrections on performs an ADC calibration to reduce the spectral image and applies the corrections.
- ❑ **IF Flat Corr** turns IF flatness corrections on and off for the Option 122 or 140 wideband IF. This control is independent of the narrowband IF flatness control.
- ❑ **Analog Filter** manually selects the 80 MHz (Option 122), 40 MHz (Option 140), or 36 MHz anti-alias filter, which overrides the automatic selection of the bandwidth.
- ❑ **WB ADC Dither** Toggles the ADC dither function on/off.. The “ADC dither” refers to the introduction of noise to the digitized steps of the analog-to-digital converter; the result is an improvement in amplitude accuracy. The wideband dither control does not affect the ADC dither in the narrowband IF path.
- ❑ **FFT Window** - Accesses the following selection menu. Unless you are familiar with FFT windows, use the flat top filter (the default filter).
  - ❑ **Flat Top** - Selects this filter for best amplitude accuracy by reducing scalloping error.
  - ❑ **Uniform** - Select this filter to have no window active by using the uniform setting.
  - ❑ **Hanning** - Press this key to activate the Hanning filter.
  - ❑ **Hamming** - Press this key to activate the Hamming filter.
  - ❑ **Gaussian** - Press this key to activate the Gaussian filter with the roll-off factor (alpha) of 3.5.
  - ❑ **Blackman** - Press this key to activate the Blackman filter.
  - ❑ **Blackman Harris** - Press this key to activate the Blackman Harris filter.
  - ❑ **K-B 70dB/90dB/110dB (Kaiser-Bessel)** - Select one of the Kaiser-Bessel filters with sidelobes at -70, -90, or -110 dBc.
- ❑ **FFT Size** - Accesses the menu to change the following parameters:
  - ❑ **Length Ctrl** - Toggles the FFT and window length setting function between **Auto** and **Man** (manual).
  - ❑ **Min Pts in RBW** - Sets the minimum number of data points that will be used inside the resolution bandwidth. The range is 0.10 to 100.00 points with 0.01 resolution. This key is grayed out if **Length Ctrl** is set to **Man**.
  - ❑ **Window Length** - Enters the FFT window length in the

number of capture samples, ranging from 8 to 1048576. This length represents the actual quantity of I/Q samples that are captured for processing by the FFT (“Capture Time” is the associated parameter shown on the screen). This key is grayed out if **Length Control** is set to **Auto**.

- ❑ **FFT Length** - Enters the FFT length in the number of captured samples, ranging from 8 to 1048576. The FFT length setting is automatically limited so that it is equal to or greater than the FFT window length setting. Any amount greater than the window length is implemented by zero-padding. This key is grayed out if **Length Control** is set to **Auto**.

- **Average**

- **Avg Number** - Changes the number of N averages.

- **Avg Mode** - Toggles the averaging mode between **Exp** (exponential) and **Repeat**. This selection only effects on the averaging result after the number of N averages is reached. The N is set using the **Avg Number** key.

- **Normal averaging:** Normal (linear) averaging is always used until the specified number of N averages is reached. When the **Measure** key under **Meas Control** is set to **Single**, data acquisition is stopped when the number of N averages is reached, thus **Avg Mode** has no effect in the single measurement mode.

- **Exponential averaging:** When **Measure** is set to **Cont**, data acquisition will continue indefinitely. Exponential averaging is used with a weighting factor of N (the displayed count of averages stops at N). Exponential averaging weights new data more heavily than old data, which allows tracking of slow-changing signals. The weighting factor N is set using the **Avg Number** key.

- **Repeat averaging:** When **Measure** is set to **Cont**, data acquisition will continue indefinitely. After the number of N averages is reached, all previous result data is cleared and the average count displayed is set back to 1. This is equivalent to being in **Measure Single** and pressing the **Restart** key each time the single measurement finishes.

- **Avg Type** - Accesses the menu of the following average types only for making spectrum (frequency domain) and waveform (time domain) measurements:

- ❑ **Pwr Avg (RMS)** - Executes the true power averaging which is calculated by averaging the rms voltage. This is the most accurate type.

Key Reference  
1xEV-DO Measurement Keys

- ❑ **Log-Pwr Avg (Video)** - Simulates the traditional spectrum analyzer type of averaging by calculating the log of the power. This type of averaging will underestimate the power when the signal is noise-like.
  - ❑ **Voltage Avg** - Executes voltage averaging.
  - ❑ **Maximum** - Captures peak voltage data. Simulates the traditional spectrum analyzer peak hold function.
  - ❑ **Minimum** - Captures the minimum voltage data, similar to the maximum function.
- **Time Avg Num** - Changes the number of time averages to be made when using the Option 122 or 140 wideband hardware (PSA only). This averaging requires a frame trigger and is much faster than the standard averaging. This hardware averaging is done on the complex voltage time trace data before any measurement application averaging is done. Both types of averaging can be done on the same measurement data.

When time averaging is being done, each trace update represents N fresh data acquisitions averaged together, where N is the number of averages. You cannot access the individual time records that are being averaged in the hardware averager.

---

**NOTE** If your triggering is not set correctly, the signal can be averaged away to nothing. A **HW Average** message is displayed to show that the averaging is on.

---

- **Trig Source**  
Key path: **Meas Setup, Trig Source**

---

**NOTE** Changing the selection in the **Trig Source** menu alters the trigger source for the selected measurement only.

---

- **Free Run (Immediate)** - A trigger occurs at the time the data is requested, completely asynchronous with the RF or IF signal.
- **Video (Envlp)** - An internal IF envelope trigger that occurs at the absolute threshold level of the IF signal level.
- **RF Burst (Wideband)** - An internal wideband RF burst trigger that has the automatic level control for burst signals. It triggers at the level that is set relative to the peak RF signal (12 MHz bandwidth) input level. (Not available for Option 122 or 140 when using the wideband IF path.)
- **Ext Front** - Activates the front panel external trigger input (**EXT TRIGGER INPUT**) port. The external signal must be between  $-5.00$  and  $+5.00$  V with 1 or 10 mV resolution.

- **Ext Rear** - Activates the rear-panel external trigger input (**TRIGGER IN**) port. The external signal must be between  $-5.00$  and  $+5.00$  V with 1 or 10 mV resolution.
- **Frame** - Uses the internal frame clock to generate a trigger signal. The clock parameters are controlled under the **Mode Setup** key or the measurement firmware, but not both. Refer to the specific measurement section for details.
- **Line** - Sets the trigger to the internal line mode. Sweep triggers occur at intervals synchronous to the line frequency. See the specific measurement section for details.
- **IF Path** Only for PSA with Option B7J and either Option 122 or 140 installed. Selects either the standard narrowband IF hardware path or the wideband hardware.
- **Restore Meas Defaults** - Presets only the settings that are specific to the selected measurement by pressing **Meas Setup, More (1 of 2), Restore Meas Defaults**. This will set the measure setup parameters, for the currently selected measurement only, to the factory defaults.
- **(Narrowband) Advanced** Accesses the menu to change the following parameters.

---

**NOTE**

---

The advanced features should be used only if you are familiar with their operation. Changes from the default values may result in invalid data.

The **Narrowband** key word is only present if you have Option B7J and either Option 122 or 140 installed. Parameters that are under the **(Narrowband) Advanced** key only affect the standard narrow band IF path. The wideband IF advanced functions are found under the **Wideband Advanced** key.

- **Pre-ADC BPF** - Toggles the pre-ADC bandpass filter function between **On** and **Off**. The pre-ADC bandpass filter is useful for rejecting nearby signals, so that sensitivity within the span range can be improved by increasing the ADC range gain.
- **Pre-FFT Filtr** - Toggles the pre-FFT filter between **Flat** (flat top) and **Gaussian**. The pre-FFT filter defaults to a flat top filter which has better amplitude accuracy. The Gaussian filter has better pulse response.
- **Pre-FFT BW** - Toggles the pre-FFT bandwidth function between **Auto** and **Man** (manual). The pre-FFT bandwidth filter can be set between 1 Hz and 10 MHz. If set to **Auto**, this pre-FFT bandwidth is nominally 50% wider than the span. This bandwidth determines the ADC sampling rate.
- **FFT Window** - Accesses the following selection menu. Unless you are familiar with FFT windows, use the flat top filter (the default filter).

- Flat Top** - Selects this filter for best amplitude accuracy by reducing scalloping error.
  - Uniform** - Select this filter to have no window active by using the uniform setting.
  - Hanning** - Press this key to activate the Hanning filter.
  - Hamming** - Press this key to activate the Hamming filter.
  - Gaussian** - Press this key to activate the Gaussian filter with the roll-off factor (alpha) of 3.5.
  - Blackman** - Press this key to activate the Blackman filter.
  - Blackman Harris** - Press this key to activate the Blackman Harris filter.
  - K-B 70dB/90dB/110dB (Kaiser-Bessel)** - Select one of the Kaiser-Bessel filters with sidelobes at -70, -90, or -110 dBc.
- **FFT Size** - Accesses the menu to change the following parameters:
- Length Ctrl** - Toggles the FFT and window length setting function between **Auto** and **Man** (manual).
  - Min Pts in RBW** - Sets the minimum number of data points that will be used inside the resolution bandwidth. The range is 0.10 to 100.00 points with 0.01 resolution. This key is grayed out if **Length Ctrl** is set to **Man**.
  - Window Length** - Enters the FFT window length in the number of capture samples, ranging from 8 to 1048576. This length represents the actual quantity of I/Q samples that are captured for processing by the FFT (“Capture Time” is the associated parameter shown on the screen). This key is grayed out if **Length Control** is set to **Auto**.
  - FFT Length** - Enters the FFT length in the number of captured samples, ranging from 8 to 1048576. The FFT length setting is automatically limited so that it is equal to or greater than the FFT window length setting. Any amount greater than the window length is implemented by zero-padding. This key is grayed out if **Length Control** is set to **Auto**.
- **ADC Range** - Accesses the menu to define one of the following ADC ranging functions:
- Auto** - Sets the ADC range automatically. For most FFT spectrum measurements, the auto feature should not be selected. An exception is when measuring a signal which is “bursty”, in which case auto can maximize the time domain dynamic range, if FFT results are less important to you than time domain results.
  - Auto Peak** - Sets the ADC range automatically to the peak

signal level. Auto peak is a compromise that works well for both CW and burst signals.

- Auto Peak Lock** - Select this to hold the ADC range automatically at the peak signal level. Auto peak lock is more stable than auto peak for CW signals, but should not be used for “bursty” signals.
- Manual** - Accesses the selection menu of values, -6 to +24 dB for E4406A or None to +18 dB for PSA, to set the ADC range level. Also note that manual ranging is best for CW signals.
- **Data Packing** - Selects **Auto** (the default) or the **Short (16 bit)**, **Medium (24 bit)** and **Long (32 bit)** methods of data packing. The short, medium, and long methods are not compatible with all settings and should not be used unless you are familiar with data packing methods. **Auto** is the preferred choice.
  - Auto** - The data packing value most appropriate for current instrument settings is selected automatically.
  - Short (16 bit)** - Select this to pack data every 16 bits.
  - Medium (24 bit)** - Select this to pack data every 24 bits.
  - Long (32 bit)** - Select this to pack data every 32 bits.
- **ADC Dither** - Toggles the ADC dither function between **Auto**, **On**, and **Off**. When set to **Auto** (the default), the ADC dither function will be activated when a narrow bandwidth is being measured, and deactivated when a wide bandwidth is being measured. “ADC dither” refers to the introduction of noise to the digitized steps of the analog-to-digital converter; the result is an improvement in amplitude accuracy. Use of the ADC dither, however, reduces dynamic range by approximately 3 dB.
- **Decimation** - Toggles the decimation function between **Auto** and **Man**, and to set the decimation value. **Auto** is the preferred setting, and the only setting that guarantees alias-free FFT spectrum measurements. If you are familiar with the decimation feature, you can change the decimation value by setting to **Man**, but be aware that aliasing can result in higher values. Decimation numbers 1 to 1000 describe the factor by which the number of points are reduced. The default setting is 0, which results in no data point reduction. Decimation by 3 keeps every 3rd sample, throwing away the 2 in between.
- **IF Flatness** - Toggles the IF flatness function between **On** and **Off**. If set to **On** (the default), the IF flatness feature causes background amplitude corrections to be performed on the FFT spectrum. The **Off** setting is used for adjustment and troubleshooting of the test instrument.

The following table shows the factory default settings for spectrum

Key Reference  
1xEV-DO Measurement Keys

(frequency domain) measurements.

Table 3-11 Spectrum (Frequency Domain) Measurement Defaults

Measurement Parameter	Factory Default Condition
Trace Display	All
Res BW	20.0000 kHz; Auto
Averaging:	
Avg Number	25; On
Avg Mode	Exp
Avg Type	Log-Pwr Avg (Video)
Time Avg Num (Opt. 122 or 140)	1
Trig Source	Free Run (Immediate)
IF Path (requires Option B7J and Option 122 or 140)	Narrow
Wideband IF Gain (Opt. 122 or 140)	0.00 dB
Wideband Filtering (Opt. 122 or 140)	None
Filter Type	0.30
Filter Alpha	0.50
Filter BW	
<b>Spectrum View:</b>	
SPAN	1.000 MHz (VSA), 10.000 MHz (PSA)
AMPLITUDE Y Scale - Scale/Div	10.00 dB
<b>I/Q Waveform View:</b>	
Capture Time	188.00 $\mu$ s
AMPLITUDE Y Scale - Scale/Div	100.0 mV
<b>Spectrum Linear View:</b>	<b>(for E4406A)</b>
SPAN	1.00000 MHz
AMPLITUDE Y Scale - Scale/Div	100.0 mV
<b>I and Q Waveform View:</b>	<b>(for E4406A)</b>
Capture Time	188.00 $\mu$ s
AMPLITUDE Y Scale - Scale/Div	100.0 mV
<b>I/Q Polar View:</b>	<b>(for E4406A)</b>
I/Q Scale/Div	100.0 mV
I or Q Origin	0.00 V
<b>(Narrowband) Advanced</b>	
Pre-ADC BPF	On
Pre-FFT Filter	Flat
Pre-FFT BW	1.55000 MHz; Auto



Table 3-11

Spectrum (Frequency Domain) Measurement Defaults

Measurement Parameter	Factory Default Condition
FFT Window	Flat Top (High Amptd Acc)
FFT Size:	
Length Control	Auto
Min Points/RBW	3.100000
Window Length	706 (VSA), 566 (PSA)
FFT Length	1024
ADC Range	Auto Peak
Data Packing	Auto
ADC Dither	Auto
Decimation	0; Auto
IF Flatness	On
<b>Wideband Advanced</b> (Option 122 or 140 PSA only)	
ADC Correction	On
IF Flatness Corrections	On
Analog Filter	Auto, 80 MHz (Opt 122), 40 MHz (Opt 140)
WB ADC Dither	On
FFT Window	Flat Top (High Amptd Acc)
FFT Size:	
Length Control	Auto
Min Points/RBW	3.100
Window Length	236 (Opt. 122), 118 (Opt. 140)
FFT Length	256 (Opt. 122), 128 (Opt. 140)

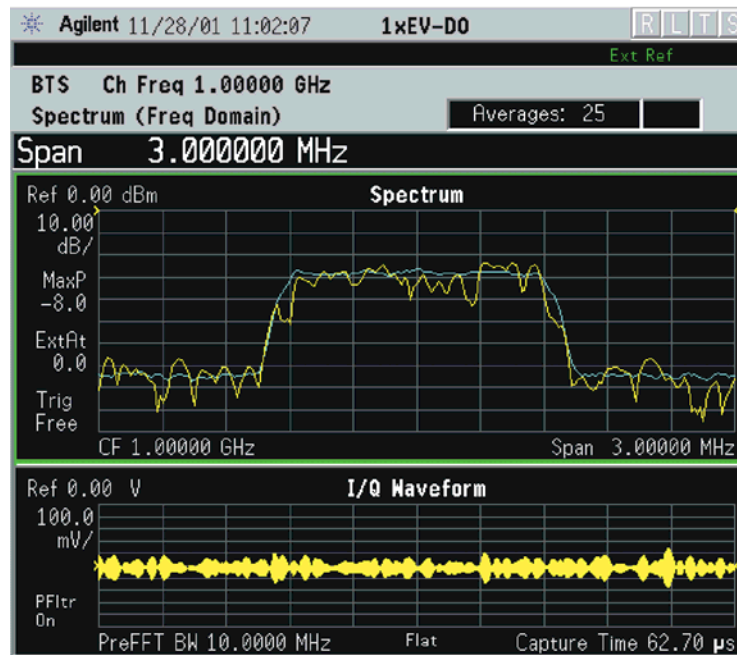
### View/Trace Key Menu

The View/Trace key allows you to select the desired view of the measurement from the following. You can use the Next Window key to move between the multiple windows (if any) and make it full size by Zoom.

- **Spectrum** - Provides a combination view of the spectrum graph in parameters of power versus frequency with semi-log graticules, and the I/Q waveform graph in parameters of voltage and time. Changes to frequency span or power will sometimes affect data acquisition. This is equivalent to changing the selected window with the **Next** key.

Figure 3-23

### Spectrum Measurement - Spectrum and I/Q Waveform (Default View)



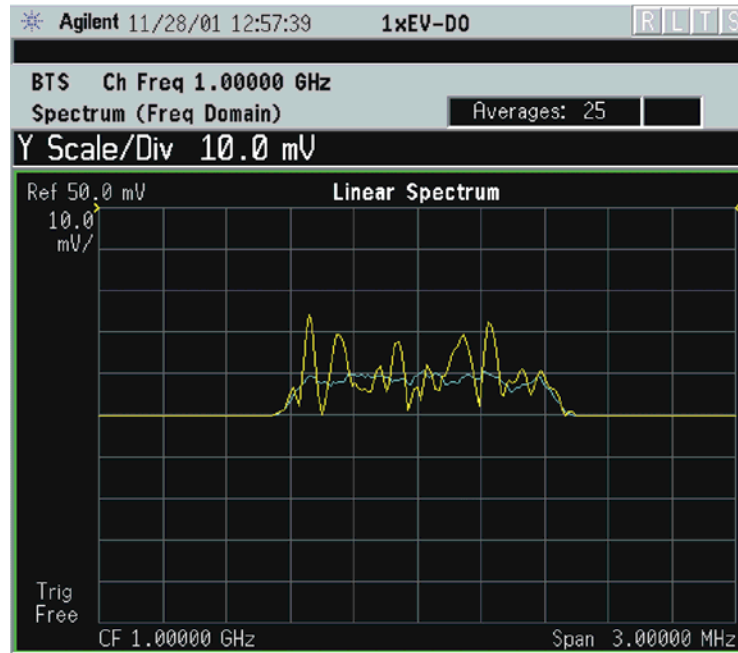
\*Meas Setup: Span = 3.000 MHz, Capture Time = 62.70 μs,  
Others = Factory default settings

\*Input signal: -10.00 dBm, Pilot channel, 1xEV-DO

- **Spectrum (Time Domain) I/Q Waveform** - (Key for PSA only) This graph is shown below the **Spectrum** graph in the default dual-window display. **I/Q Waveform** provides a view of the I/Q waveform in parameters of voltage versus time in linear scale. Changes to sweep time or resolution bandwidth can affect data acquisition. Pressing this button is equivalent to pressing the **Next Window** button on the front panel. Press the **Zoom** key to view this display full-screen.

- **Spectrum Linear** - (for E4406A) Provides a view of the spectrum graph in parameters of voltage versus frequency in linear scale. Changes to frequency span or voltage can affect data acquisition.

**Figure 3-24 Spectrum Measurement - Linear Spectrum View (for E4406A)**



\*Meas Setup: View/Trace = Spectrum Linear,  
Span = 3.000 MHz,  
Y Scale/Div = 10.00 mV, Ref Value = 50.0 mV,  
Others = Factory default settings

\*Input signals: -10.00 dBm, Pilot channel, 1xEV-DO

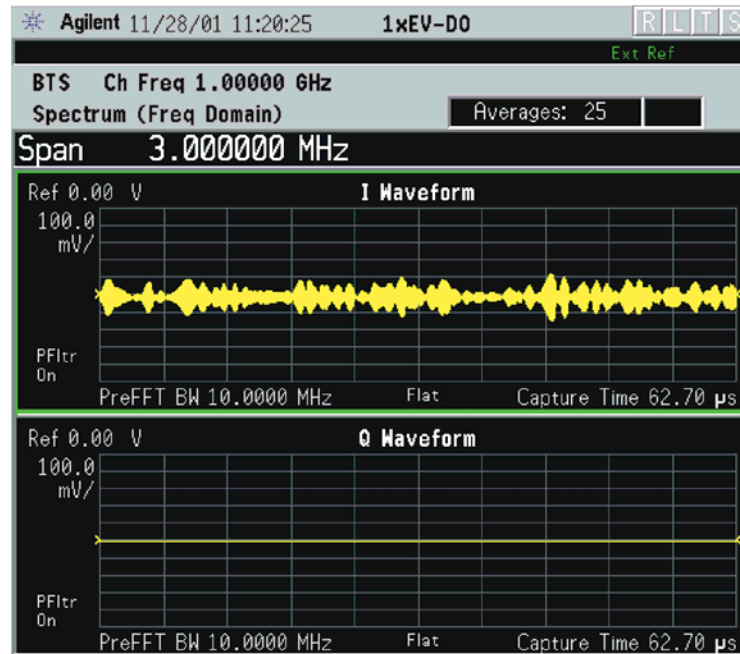
**NOTE**

(for E4406A) For the widest spans, the I/Q window becomes just “ADC time domain samples”, because the I/Q down-conversion is no longer in effect. This is not the case for E4406A Option B7C if the **Input Port** is set to either **I/Q**, **I only**, or **Q only** and you have connected baseband I/Q signals to the **I/Q INPUT** connectors.

- **I and Q Waveform** - (for E4406A) Provides individual views of the I and Q signal waveform windows in parameters of voltage versus time.

To select the I or Q trace view, press the **Next** key at the bottom of the display. The selected window will have a green outline. To view the window full size press the **Zoom** key.

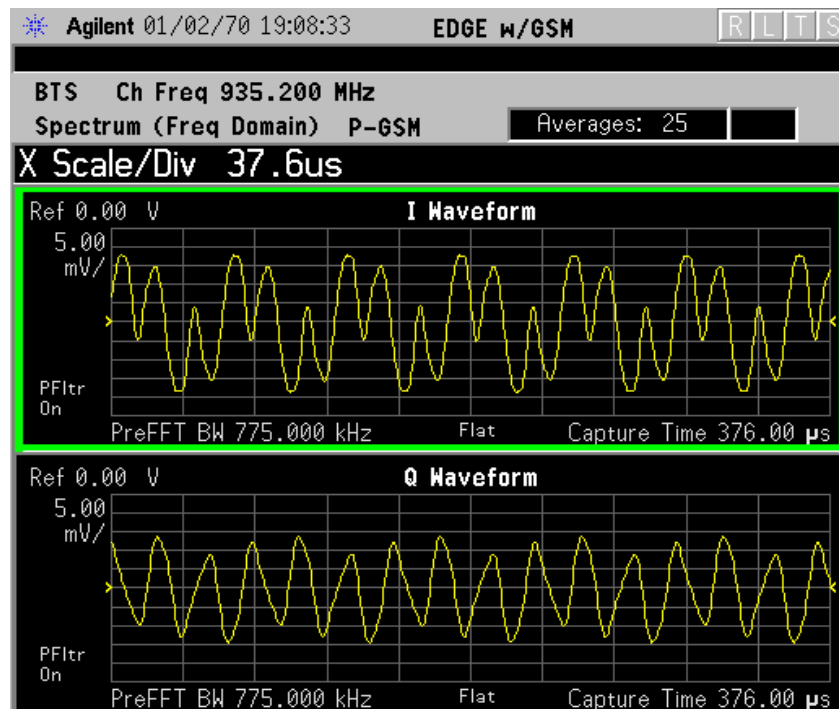
**Figure 3-25 Spectrum Measurement - I and Q Waveform View (for E4406A)**



\*Meas Setup: View/Trace = I and Q Waveform,  
Others = Factory default settings

\*Input signals: -10.00 dBm, Pilot channel, 1xEV-DO

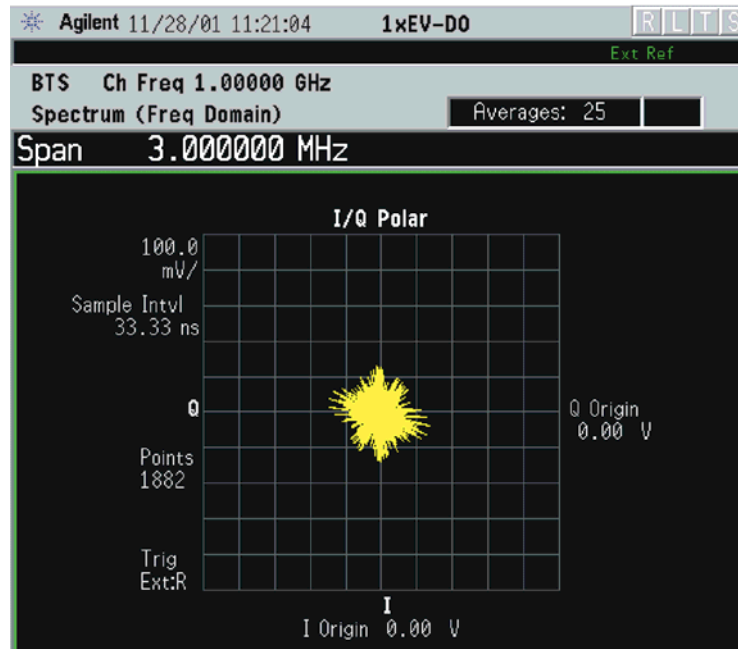
**Figure 3-26 Spectrum Measurement - I and Q Waveform View (for E4406A)**



- **I/Q Polar** - (for E4406A) Provides a view of the I/Q signal displayed in

a polar vector graph.

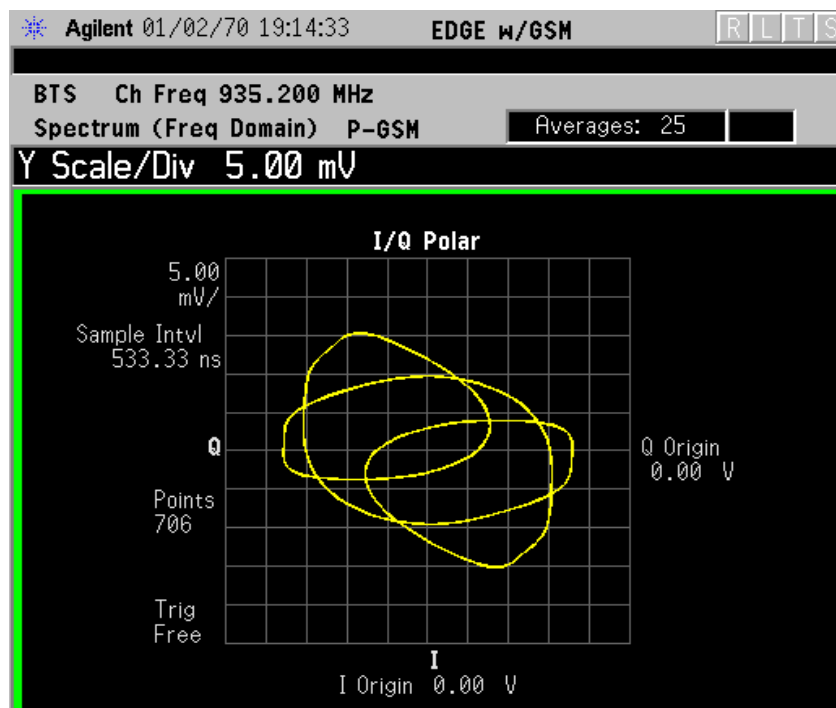
**Figure 3-27 Spectrum Measurement - I/Q Polar View (for E4406A)**



\*Meas Setup: View/Trace = I/Q Polar,  
Others = Factory default settings

\*Input signals: -10.00 dBm, Pilot channel, 1xEV-DO

**Figure 3-28 Spectrum Measurement - I/Q Polar View (for E4406A)**



## Key Reference

## 1xEV-DO Measurement Keys

- **Trace Display** - Press this key to reveal the trace selection menu. The currently selected trace type is shown on the **Trace Display** key.
  - **All** - Views both the current trace and the average trace.
  - **Average** - Views only the average trace (in blue color). See the **Meas Setup, Average** keys to select different types of averaging.
  - **Current** - Views only the trace (in yellow color) for the latest data acquisition.
  - **I Trace** - (for E4406A) Views only the I signal trace.
  - **Q Trace** - (for E4406A) Views only the Q signal trace.

**SPAN X Scale Key Menu****NOTE**

The **Spectrum** or **Linear Spectrum** (for E4406A) window must be active in the **Spectrum** or **Spectrum Linear** (for E4406A) view to access the following **Span X Scale** key menu:

- **Span** - Modifies the frequency span. The range is 10.000 Hz to 10.000 MHz with 1 Hz resolution, depending on the **Res BW** setting. Changing the span causes the resolution bandwidth to change automatically, and will affect data acquisition time. The **Span** key is also accessible under the **Meas Setup** menu.
- **IF Path** - This key is only available if you have Option B7J and either Option 122 or 140. Selects either the standard narrowband IF hardware path or the wideband hardware path.

**NOTE**

(for E4406A) or **Spectrum Linear** (for E4406A)

- **Scale/Div** - Sets the horizontal scale by changing a time value per division. The range is 1.00 ns to 1.00 s per division. The default setting is 18.8 ms per division. However, since the **Scale Coupling** default is **On**, this value is automatically determined by the measurement results. When you set a value manually, **Scale Coupling** automatically changes to **Off**.
- **Ref Value** - Sets the reference value ranging from -1.00 to 10.0 s. The default setting is 0.00 s. However, since the **Scale Coupling** default is **On**, this value is automatically determined by the measurement results. When you set a value manually, **Scale Coupling** automatically changes to **Off**.
- **Ref Position** - Sets the reference position to either **Left**, **Ctr** (center) or **Right**. The default setting is **Left**.
- **Scale Coupling** - Toggles the scale coupling function between **On** and **Off**. The default setting is **On**. Upon pressing the **Restart** front-panel key or **Restart** softkey under the **Meas Control** menu, this function automatically determines the scale per division and reference values

based on the measurement results. When you set a value to either **Scale/Div** or **Ref Value** manually, **Scale Coupling** automatically changes to **Off**.

**NOTE**

The **I/Q Polar** window must be active in the **I/Q Polar** view (for E4406A), for the **SPAN X Scale** key to access the following menu:

- **I/Q Scale/Div** - Sets the vertical and horizontal scales by changing the value per division. The range is 1.00 nV to 20.00 V per division. The default setting is 100.0 mV.
- **I Origin** or **Q Origin** - Sets the reference value ranging from -250.00 to 250.00 V. The default setting is 0.00 V.

**AMPLITUDE Y Scale Key Menu**

**NOTE**

The **Spectrum** or **Linear Spectrum** (for E4406A) window must be active in the **Spectrum** or **Spectrum Linear** (for E4406A) view to access the following **AMPLITUDE Y Scale** key menu:

- **Scale/Div** - Sets the vertical scale by changing an amplitude value per division. The range is 0.10 dB to 20.00 dB per division or 1.00 nV to 20.00 V per division, respectively. The default setting is 10.00 dB or 100.0 mV. However, since the **Scale Coupling** default is **On**, this value is automatically determined by the measurement results. When you set a value manually, **Scale Coupling** automatically changes to **Off**.
- **Ref Value** - Sets the reference value ranging from -250.00 to 250.00 dBm or -250.00 to 250.00 V. The default setting is 0.00 dBm or 0.00 V. However, since the **Scale Coupling** default is **On**, this value is automatically determined by the measurement results. When you set a value manually, **Scale Coupling** automatically changes to **Off**.
- **Ref Position** - Sets the reference position to either **Top**, **Ctr** (center) or **Bot** (bottom). The default setting is **Ctr**.
- **Scale Coupling** - Toggles the scale coupling function between **On** and **Off**. The default setting is **On**. Upon pressing the **Restart** front-panel key or **Restart** softkey under the **Meas Control** menu, this function automatically determines the scale per division and reference values based on the measurement results. When you set a value to either **Scale/Div** or **Ref Value** manually, **Scale Coupling** automatically changes to **Off**.

**NOTE**

The **I** or **Q** **Waveform** window must be active in the **I and Q Waveform** view (**for E4406A**) for the **AMPLITUDE Y Scale** key to access the following menu:

- **Scale/Div** - Sets the vertical scale by changing the amplitude value per division. The range is 1.00 nV to 20.00 V per division. The

## Key Reference

### 1xEV-DO Measurement Keys

default setting is 100.0 mV. However, since the **Scale Coupling** default is **On**, this value is automatically determined by the measurement results. When you set a value manually, **Scale Coupling** automatically changes to **Off**.

- **Ref Value** - Sets the reference value ranging from -250.00 to 250.00 V. The default setting is 0.00 V. However, since the **Scale Coupling** default is **On**, this value is automatically determined by the measurement results. When you set a value manually, **Scale Coupling** automatically changes to **Off**.
- **Ref Position** - Sets the reference position to either **Top**, **Ctr** (center) or **Bot** (bottom). The default setting is **Ctr**.
- **Scale Coupling** - Toggles the scale coupling function between **On** and **Off**. The default setting is **On**. The **Restart** front-panel key or **Restart** softkey under the **Meas Control** menu, this function automatically determines the scale per division and reference values by the measurement results. When you set a value to either **Scale/Div** or **Ref Value** manually, **Scale Coupling** automatically changes to **Off**.

---

#### NOTE

---

The I/Q Polar window must be active in the **I/Q Polar** view (for E4406A), for the **AMPLITUDE Y Scale** key to access the following menu:

- **I/Q Scale/Div** - Sets the vertical and horizontal scales by changing the value per division. The range is 1.00 nV to 20.00 V per division. The default setting is 100.0 mV.
- **I Origin** or **Q Origin** - Sets the reference value ranging from -250.00 to 250.00 V. The default setting is 0.00 V.

#### Display Key Menu

The Display Key is not active for this measurement.

#### Marker Key Menu

- **Select 1 2 3 4** - Activates up to four markers with the corresponding numbers, respectively. The selected number is underlined and its function is defined by pressing the **Function** key. The default is 1.
- **Normal** - Activates the selected marker to read the frequency and amplitude of the marker position on the spectrum trace. Marker position is controlled by the **RPG** knob.
- **Delta** - Reads the differences in frequency and amplitude between the selected marker and the next marker.
- **Function Off** - Selects marker function to be **Band Power**, **Noise**, or **Off**. The default is **Off**. If set to **Band Power**, you need to select **Delta**.
- **Trace Spectrum** - Places the selected marker on the **Spectrum**, **Spectrum Avg**, **Spectrum Linear** (for E4406A), **Spectrum Avg Linear** (for



E4406A), **I/Q Waveform**, **I Waveform** (for E4406A), or **Q Waveform** (for E4406A) trace. The default is **Spectrum**.

- **Off** - Turns off the selected marker.
- **Shape Diamond** - Accesses the menu to define the selected marker shape to be **Diamond**, **Line**, **Square**, or **Cross**. The default shape is **Diamond**.
- **Marker All Off** - Turns off all of the markers.

### Peak Search Key

The front panel Search key performs a peak search when pressed. A marker will automatically be activated at the highest peak.

### Spurious Emissions & ACP Keys (Radio Device = BTS only)

---

**NOTE**

---

Select key path: **MEASURE, Spurious Emissions & ACP** to access these menus.

### Meas Setup Key Menu

Key Path: **Spurious Emissions & ACP, Meas Setup**

- **Avg Number** - Allows you to change the number of N averages to be made.
- **Avg Mode** - Allows you to toggle the averaging mode between **Exp** (exponential) and **Repeat**. This selection only effects on the averaging result after the number of N averages is reached. The N is set using the **Avg Number** key.
  - **Normal averaging**: Normal (linear) averaging is always used until the specified number of N averages is reached. When the **Measure** key under **Meas Control** is set to **Single**, data acquisition is stopped when the number of N averages is reached, thus **Avg Mode** has no effect in the single measurement mode.
  - **Exponential averaging**: When **Measure** is set to **Cont**, data acquisition will continue indefinitely. Exponential averaging is used with a weighting factor of N (the displayed count of averages stops at N). Exponential averaging weights new data more heavily than old data, which allows tracking of slow-changing signals. The weighting factor N is set using the **Avg Number** key.
  - **Repeat averaging**: When **Measure** is set to **Cont**, data acquisition will continue indefinitely. After the number of N averages is reached, all previous result data is cleared and the average count displayed is set back to 1. This is equivalent to being in **Measure Single** and pressing the **Restart** key each time the

Key Reference  
1xEV-DO Measurement Keys

single measurement finishes.

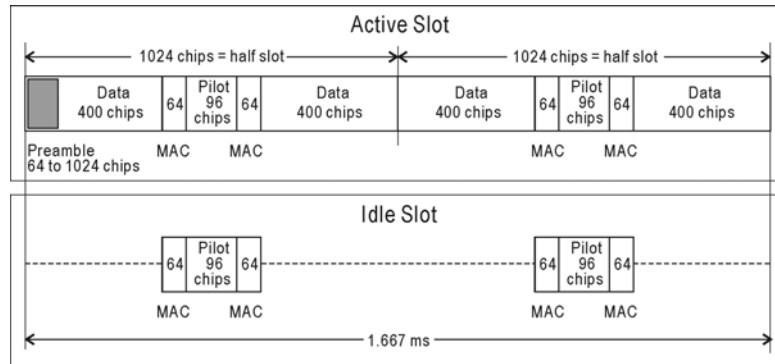
- **Meas Mode** - Allows you to toggle the measurement mode between **ACP** and **SEM**. When set to **ACP**, the adjacent channel power measurement is made with the optimized offset and limits defined by **Offset/Limits**. When set to **SEM**, the spurious emissions measurement is made with the optimized offset and limits defined by **Offset/Limits**.
- **Trig Source** - Allows you to select one of the trigger sources: **Free Run (Immediate)**, **Ext Front**, **Ext Rear**, **Frame**, and **Line**.
- **Detector** - Allows you to toggle the power detection type between **Avg** (average) and **Peak**. When set to **Avg**, the power in a bin is computed as RMS averaged over the entire **Meas Interval**. When set to **Peak**, the peak power in the entire **Meas Interval** is converted to the RMS value, assuming a CW signal.
- **Meas Type** - Allows you to access the menu to select one of the measurement reference types.
  - **Total Pwr Ref** - Sets the reference to the total carrier power and the measured data is shown in dBc and dBm.
  - **PSD Ref** - Sets the reference to the mean power spectral density of the carrier and the measured data is shown in dB and dBm/Hz.
- **Meas Offset & Interval** - Allows you to access the following menu to set the measurement offset and interval:
  - **Meas Offset** - Allows you to set a value of measurement offset in either  $\mu\text{s}$  or chips. When you enter a numeric value, the unit selection menu is shown. The range is from 0 to 1667.0  $\mu\text{s}$ , or 0 to 2048 chips.
  - **Meas Interval** - Allows you to set a value of measurement interval in either  $\mu\text{s}$  or chips. When you enter a numeric value, the unit selection menu is shown. The range is from 0  $\mu\text{s}$  to 10.000 ms, or 13 to 224 chips.
  - **Pre-Defined Ofs/Intvl** - Allows you to access the menu to select one of the predefined measurement offsets and intervals depending on the slots. The slot definitions are summarized in the illustration and table below.
    - Idle Slot** - Allows you to access the menu to select either idle slot #1 or #2 for the preset measurement offset and interval.
      - Idle Slot #1** - Refer to the illustration and table below for details.
      - Idle Slot #2** - Refer to the illustration and table below for details.
    - Half Slot** - Allows you to access the menu to select either half

slot #1 or #2 for the preset measurement offset and interval.

**Half Slot #1** - Refer to the illustration and table below for details.

**Half Slot #2** - Refer to the illustration and table below for details.

- ❑ **Full Slot** - Allows you to set the full slot with 2048 chips for the preset measurement offset and interval.



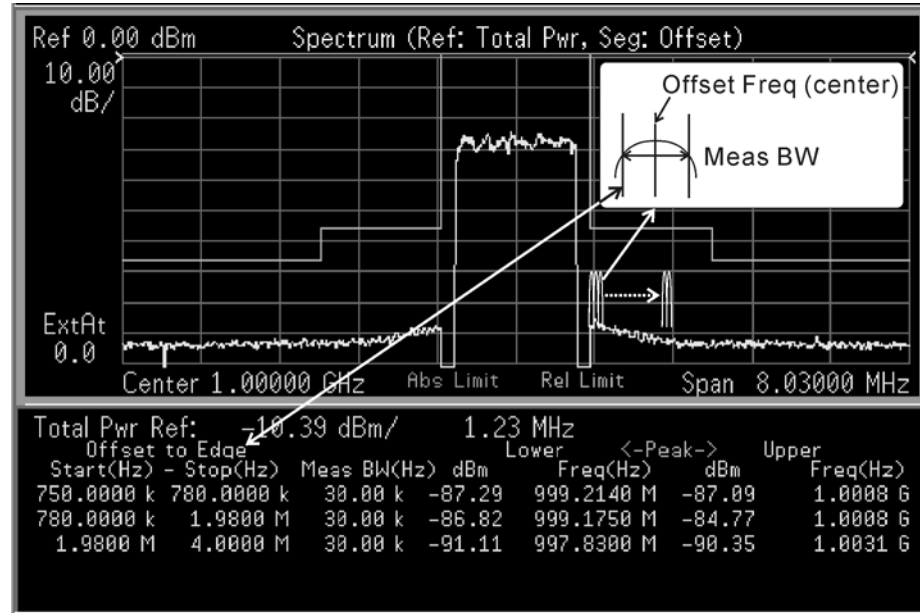
Selection	Meas Offset		Meas Interval	
	Time ( $\mu$ s)	Chips	Time ( $\mu$ s)	Chips
Idle Slot #1	325.5	400	182.3	224
Idle Slot #2	1158.9	1424	182.3	224
Half Slot #1	0.0	0	833.3	1024
Half Slot #2	833.3	1024	833.3	1024
Full Slot	0.0	0	1666.7	2048

- **Ref Channel** - Allows you to define the reference channel in the following terms:
  - **Chan Integ BW** - Allows you to specify a value for the channel integration bandwidth. The range is from 30.0 kHz to 20.00 MHz.
  - **Chan Span** - Allows you to specify a value for the channel span to be measured. The range is from 100.000 kHz to 10.0000 MHz.
  - **Step Freq** - Allows you to specify the step frequency to make measurements ranging from 100.0 Hz to 7.50000 MHz, and to toggle this function between **Auto** and **Man**. When set to **Auto**, this is automatically set to half the **Res BW** setting. When set to **Man**, the step frequency is manually set independently from **Res BW**.
  - **Res BW** - Allows you to specify the resolution bandwidth ranging from 1.000 kHz to 1.000 MHz, and to toggle this function between **Auto** and **Man**. When set to **Auto**, **Res BW** is automatically set to one 50th of **Chan Integ BW**. The Gaussian shaped filter is used.

Key Reference  
1xEV-DO Measurement Keys

- **Spectrum Segment** - Allows you to toggle the frequency spectrum segment between **Offset** and **Region**. According to this selection, either the **Offset/Limits** menu or the **Region & Limits** menu is available. When you select **Offset**, ACP or spurious emissions measurements are made depending on the **Meas Type** selection. When you select **Region**, spurious emissions measurements are made.
- **Offset/Limits** - Allows you to access the menus to change the following parameters for offset frequency settings and pass/fail test conditions, when you set **Spectrum Segment** to **Offset**. For both the **SEM** and **ACP** measurement modes the individual offsets and limits are configurable. [Table 3-12](#) and [Table 3-13](#) show the default settings for SEM and ACP mode measurements, respectively.

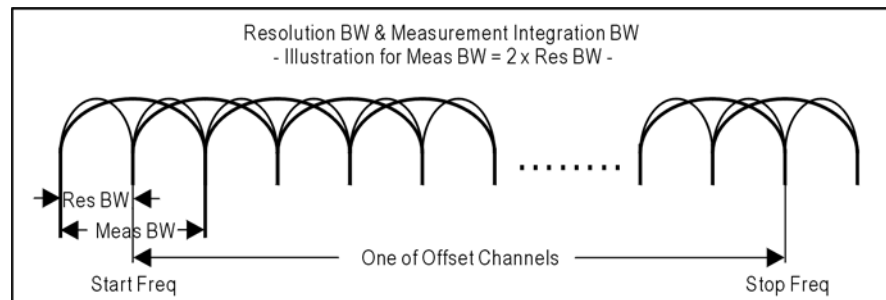
When **Spectrum Segment** is set to **Offset**, the frequency values at Start (Hz) and Stop (Hz) are shown as Offset to Edge in the measurement result window considering the measurement bandwidth, as it is different from the offset frequency center as shown in the following illustration. In addition, when **Meas Mode** is set to **ACP**, each frequency pair in Start (Hz) and Stop (Hz) becomes the same frequency values for adjacent channel power measurements. For example, when the measurement bandwidth is set to 30 kHz, the first offset center frequency can be 765 kHz and the offset to edge frequency can be 750 kHz.



- **Offset** - Allows you to access the memory selection menu from **A** through **E** to store up to 5 sets of values for **Start Freq**, **Stop Freq**, **Step Freq**, **Res BW**, and **Limits**. Only one memory selection at a time (A, B, C, D, or E) is shown on this key label.
- **Start Freq** - Allows you to specify a value for the start center

frequency, and to toggle this function between **On** and **Off**, for each offset. The frequency range is 10.0000 kHz to 100.000 MHz with 100 Hz resolution. However, the high end is limited to the setting of **Stop Freq**. When **Spectrum Segment** is set to **Offset**, the frequency values at **Start** (Hz) are shown as **Offset to Edge** in the measurement result window considering the measurement bandwidth.

- **Stop Freq** - Allows you to specify a value for the stop center frequency. The frequency range is from 10.0000 kHz to 100.000 MHz with 100 Hz resolution, for each offset. The low end is limited to the setting of **Start Freq**. When **Spectrum Segment** is set to **Offset**, the frequency values at **Stop** (Hz) are shown as **Offset to Edge** in the measurement result window considering the measurement bandwidth.
- **Step Freq** - Allows you to specify a value for the step frequency. The frequency range is from  $(\text{Stop Freq} - \text{Start Freq})/10000$  to  $(\text{Stop Freq} - \text{Start Freq})$ , and to toggle this function between **Auto** and **Man**, for each offset. When set to **Auto**, the step frequency is automatically set to half the **Res BW** setting. When you set **Meas BW** to other than 1 of **Res BW**, **Step Freq** is disabled because **Res BW** is automatically set to the step frequency.
- **Res BW** - Allows you to specify a value for the resolution bandwidth. The range is from 300.0 Hz to 7.50000 MHz with 100 Hz resolution, and to toggle this function between **Auto** and **Man**, for each offset. When set to **Auto**, **Res BW** is automatically set to one 50th of  $(\text{Stop Freq} - \text{Start Freq})$ . The Gaussian shaped filter is used. The next figure illustrates the relationships between **Meas BW**, **Start Freq**, and **Stop Freq**.



- **Meas BW (Integ BW)** - Allows you to specify a multiplier of **Res BW** for the measurement integration bandwidth. The range is from 1 to an integer derived from  $(\text{Stop Freq} - \text{Start Freq})/\text{Res BW}$ . Refer to the illustration under **Res BW** above.
- **Relative Atten** - Allows you to enter an attenuation value to adjust the relative level limits ranging from -40.00 to 40.00 dB with 0.01 dB resolution. The default attenuation is the same as the one used by **Ref Channel**.

- **Offset Side** - Allows you to specify which offset side is to be measured. Selections are **Neg** (negative offset), **Both**, and **Pos** (positive offset).
- **Limits** - Allows you to access the following menu to set up an absolute and relative limit level and fail condition for each offset:
  - ❑ **Abs Start** - Allows you to enter an absolute level limit at **Start Freq**. The range is from -200.00 to +50.00 dBm with 0.01 dB resolution.
  - ❑ **Abs Stop** - Allows you to enter an absolute level limit at **Stop Freq**. The range is from -200.00 to +50.00 dBm with 0.01 dB resolution, and to toggle this function between **Couple** and **Man**. When set to **Couple**, **Abs Stop** is coupled to **Abs Start** to make a flat limit line. When set to **Man**, **Abs Start** and **Abs Stop** can take different values to make a sloped limit line.
  - ❑ **Rel Start** - Allows you to enter a relative level limit at **Start Freq**. The range is from -150.00 to +50.00 dBc with 0.01 dB resolution.
  - ❑ **Rel Stop** - Allows you to enter a relative level limit at **Stop Freq**. The range is from -150.00 to +50.00 dBc with 0.01 dB resolution, and to toggle this function between **Couple** and **Man**. When set to **Couple**, **Rel Stop** is coupled to **Rel Start** to make a flat limit line. When set to **Man**, **Rel Start** and **Rel Stop** can take different values to make a sloped limit line.
  - ❑ **Fail Mask** - Allows you to access the following menu to select one of the logic keys for fail conditions between the measurement results and the test limits:
    - Absolute - Fail is shown when one of the absolute measurement results is larger than the limit for **Abs Start** and/or **Abs Stop**.
    - Relative - Fail is shown when one of the relative measurement results is larger than the limit for **Rel Start** and/or **Rel Stop**. This is the default selection for the offset **A** and **B**.
    - Abs AND Rel - Fail is shown when one of the absolute measurement results is larger than the limit for **Abs Start** and **Abs Stop** AND one of the relative measurement results is larger than the limit for **Rel Start** and **Rel Stop**.
    - Abs OR Rel** - Fail is shown when one of the absolute measurement results is larger than the limit for **Abs Start** and **Abs Stop** OR one of the relative measurement results is

larger than the limit for **Rel Start** and **Rel Stop**.

Table 3-12 SEM Mode Offset & Limit Defaults

Offset	Start Freq (MHz)	Stop Freq (MHz)	Res BW (kHz)	Meas BW (kHz)	Abs Start (dBm)	Abs Stop (dBm)	Rel Start (dBc)	Rel Stop (dBc)	Fail Mask
A, On	0.7650	0.7950	3.000	30.00	-27.00	-27.00	-45.00	-45.00	Rel
B, On	0.7950	1.9950	30.00	30.00	-27.00	-27.00	-45.00	-45.00	Rel
C, Off	1.9950	4.0150	30.00	30.00	-27.00	-27.00	-55.00	-55.00	Rel
D, Off	3.2531	4.0031	6.25	6.25	-46.00	-46.00	-55.00	-55.00	Abs
E, Off	7.5000	12.500	1000.0	1000.0	-13.00	-13.00	-55.00	-55.00	Rel

Table 3-13 ACP Mode Offset & Limit Defaults

Offset	Start Freq (MHz)	Stop Freq (MHz)	Res BW (kHz)	Meas BW (kHz)	Abs Start (dBm)	Abs Stop (dBm)	Rel Start (dBc)	Rel Stop (dBc)	Fail Mask
A, On	0.7650	0.7650	3.000	30.00	-27.00	-27.00	-45.00	-45.00	Rel
B, On	1.9950	1.9950	30.00	30.00	-27.00	-27.00	-55.00	-55.00	Rel
C, Off	3.1250	3.1250	30.00	30.00	-13.00	-13.00	-55.00	-55.00	Abs
D, Off	4.0000	4.0000	30.00	30.00	-13.00	-13.00	-55.00	-55.00	Rel
E, Off	7.5000	7.5000	30.00	30.00	-13.00	-13.00	-55.00	-55.00	Rel

- **Region & Limits** - Allows you to access the menus to change the following parameters for region frequency settings and pass/fail test conditions, when **Spectrum Segment** is set to **Region**. [Table 3-14](#) shows the default settings for SEM mode measurements.
  - **Region** - Allows you to access the memory selection menu from **A** through **E** to store up to 5 sets of values for **Start Freq**, **Stop Freq**, **Step Freq**, **Res BW**, and **Limits**. Only one memory selection at a time (A, B, C, D, or E) is shown on this key label. The default setting is **A**.
  - **Start Freq** - Allows you to specify a value for the start frequency, and to toggle this function between **On** and **Off**, for each region. The frequency range is 329.000 MHz to 3.67800 GHz with 1 kHz resolution. However, the high end is limited to the setting of **Stop Freq**. The default settings are 1.92000 GHz and **On**.
  - **Stop Freq** - Allows you to specify a value for the stop frequency. The frequency range is from 329.000 MHz to 3.67800 GHz with 1 kHz resolution, for each region. The low end is limited to the setting of **Start Freq**. The default setting is 1.98000 GHz.

- **Step Freq** - Allows you to specify a value for the step frequency. The range is from  $(\text{Stop Freq} - \text{Start Freq})/10000$  to  $(\text{Stop Freq} - \text{Start Freq})$ , and to toggle this function between **Auto** and **Man**, for each region. When set to **Auto**, the step frequency is automatically set to half the **Res BW** setting. The default settings are 600.000 kHz and **Auto**.
- **Res BW** - Allows you to specify a value for the resolution bandwidth. The frequency range is from 1.000 kHz to 7.5000 MHz with 100 Hz resolution, and to toggle this function between **Auto** and **Man**, for each region. When set to **Auto**, the resolution bandwidth is automatically set to one 50th of  $(\text{Stop Freq} - \text{Start Freq})$ . The Gaussian shaped filter is used. The default settings are 1.20000 MHz and **Auto**.
- **Relative Atten** - Allows you to enter an attenuation value to adjust the relative level limits. The range is from -40.00 to 40.00 dB with 0.01 dB resolution. The default attenuation is the same as the one used for **Ref Channel**.
- **Limits** - Allows you to access the following menu to set up an absolute and relative limit level and fail condition for each region:
  - Abs Start** - Allows you to enter an absolute level limit at **Start Freq**. The range is from -200.00 to +50.00 dBm with 0.01 dB resolution. The default setting is -50.00 dBm.
  - Abs Stop** - Allows you to enter an absolute level limit at **Stop Freq**. The range is from -200.00 to +50.00 dBm with 0.01 dB resolution, and to toggle this function between **Couple** and **Man**. When set to **Couple**, **Abs Stop** is coupled to **Abs Start** to make a flat limit line. When set to **Man**, **Abs Start** and **Abs Stop** can take different values to make a sloped limit line. The default settings are -50.00 dBm and **Couple**.
  - Rel Start** - Allows you to enter a relative level limit. The range is from -150.00 to +50.00 dBc with 0.01 dB resolution. The default settings are -30.00 dBm.
  - Rel Stop** - Allows you to enter a relative level limit at **Stop Freq**. The range is from -150.00 to +50.00 dBc with 0.01 dB resolution, and to toggle this function between **Couple** and **Man**. When set to **Couple**, **Rel Stop** is coupled to **Rel Start** to make a flat limit line. When set to **Man**, **Rel Start** and **Rel Stop** can take different values to make a sloped limit line. The default settings are -30.00 dBm and **Couple**.
  - Fail Mask** - Allows you to access the following menu to select one of the logic keys for fail conditions between the measurement results and the test limits. The default selection is **Absolute**.

**Absolute** - Fail is shown whenWhen one of the absolute



spurious emissions measurement results is larger than the limit for **Abs Start** and/or **Abs Stop**. This is the default selection for each region.

**Relative** - Fail is shown when one of the relative spurious emissions measurement results is larger than the limit for **Rel Start** and/or **Rel Stop**.

**Abs AND Rel** - Fail is shown when one of the absolute spurious emissions measurement results is larger than the limit for **Abs Start** and **Abs Stop** AND one of the relative spurious emissions measurement results is larger than the limit for **Rel Start** and **Rel Stop**.

**Abs OR Rel** - Fail is shown when one of the absolute spurious emissions measurement results is larger than the limit for **Abs Start** and **Abs Stop** OR one of the relative spurious emissions measurement results is larger than the limit for **Rel Start** and **Rel Stop**.

**Table 3-14 SEM Mode Region & Limit Defaults**

Region	Start Freq (GHz)	Stop Freq (GHz)	Step Freq (kHz)	Res BW (kHz)	Abs Start (dBm)	Abs Stop (dBm)	Rel Start (dBc)	Rel Stop (dBc)	Fail Mask
A, On	1.9200	1.9800	600.0	1200.0	-50.00	-50.00	-30.00	-30.00	Abs
B, On	1.8935	1.9196	261.0	522.0	-50.00	-50.00	-30.00	-30.00	Abs
C, On	2.1000	2.1050	50.0	100.0	-50.00	-50.00	-30.00	-30.00	Abs
D, Off	2.1750	2.1800			-50.00	-50.00	-30.00	-30.00	Abs
E, Off	0.8000	1.0000			-50.00	-50.00	-30.00	-30.00	Abs

**Table 3-15** shows the factory default settings for spurious emissions and ACP measurements.

**Table 3-15 Spurious Emissions and ACP Measurement Defaults**

Measurement Parameter	Factory Default Condition
View/Trace	All
Display	Abs Peak Pwr & Freq
Limit Lines	On
Meas Setup:	
Avg Number	10; Off
Avg Mode	Repeat
Meas Mode	SEM
Trig Source	Free Run (Immediate)
Detector	Avg (averaged power)

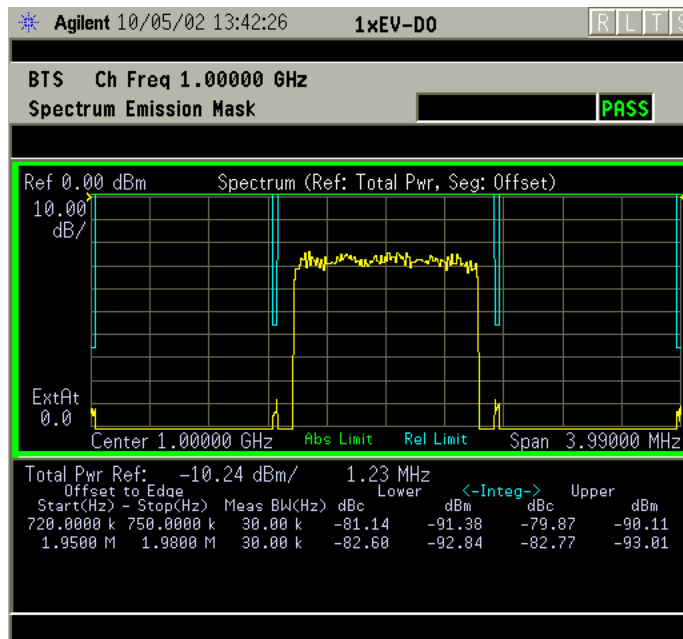
Table 3-15 Spurious Emissions and ACP Measurement Defaults

Measurement Parameter	Factory Default Condition
Meas Type	Total Pwr Ref
Meas Offset & Interval:	
Meas Offset	325.5 $\mu$ s
Meas Interval	182.3 $\mu$ s
Pre-Defined Ofs/Intvl:	
Idle Slot	Idle Slot #1
Ref Channel:	
Chan Integ BW	1.23000 MHz
Chan Span	1.25000 MHz
Step Freq	12.3000 kHz; Auto
Res BW	24.6000 kHz; Auto
Spectrum Segment	Offset
Offset/Limits:	(Refer to <a href="#">Table 3-12 on page 263</a> )
Offset	A
Start Freq	765.000 kHz
Stop Freq	765.000 kHz
Step Freq	1.500 kHz; Auto
Res BW	3.000 kHz; Man
Meas BW (Integ BW)	10 $\times$ Res BW
Relative Atten	0.00 dB
Offset Side	Both
Limits:	
Abs Start	-27.00 dBm
Abs Stop	-27.00 dBm; Couple
Rel Start	-45.00 dBc
Rel Stop	-45.00 dBc; Couple
Fail Mask	Relative

**View/Trace Key Menu**Key Path: **Spurious Emissions & ACP, View/Trace****NOTE**When **Spectrum Segment** is set to **Offset**, the following menu is shown:

- **All** - In the factory default condition, the ACP or spurious emissions measurement graph is displayed with all of the active offsets in the graph window as shown in [Figure 3-29](#).

**Figure 3-29** Spurious Emissions Measurement - Offset View

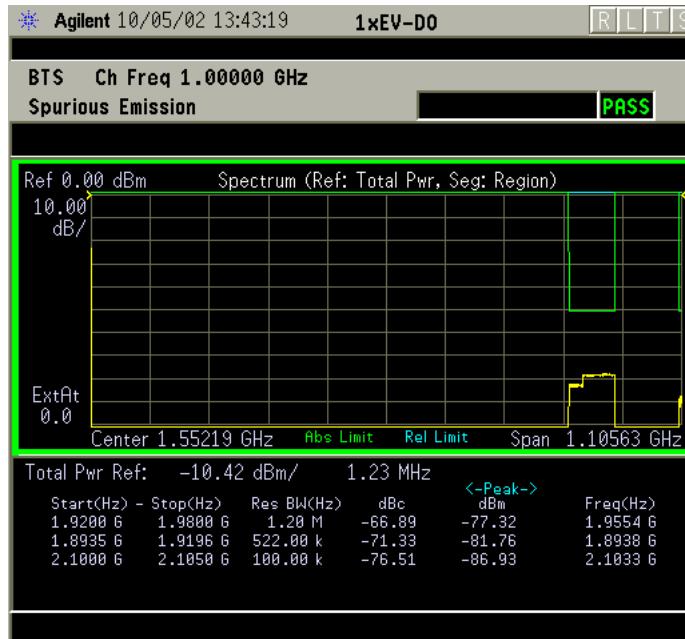


- **Offset A** through **Offset E** - Each of ACP or spurious emissions measurement results, up to 5 sets of offsets, is shown in the graph window. Each offset label set to **Off** is grayed out.
- **Offset Side** - Allows you to toggle the display function of the offset sides between **Pos** (positive) and **Neg** (negative).

**NOTE**

When **Spectrum Segment** is set to **Region**, the following menu is shown.

- **All** - The spurious emissions measurement graph is displayed with all of the active regions in the graph window as shown in [Figure 3-30](#).

**Figure 3-30 Spurious Emissions and ACP Measurement - All Regions View**

\*Tester:           Spectrum Segment = Region,  
                      Others = Factory default settings

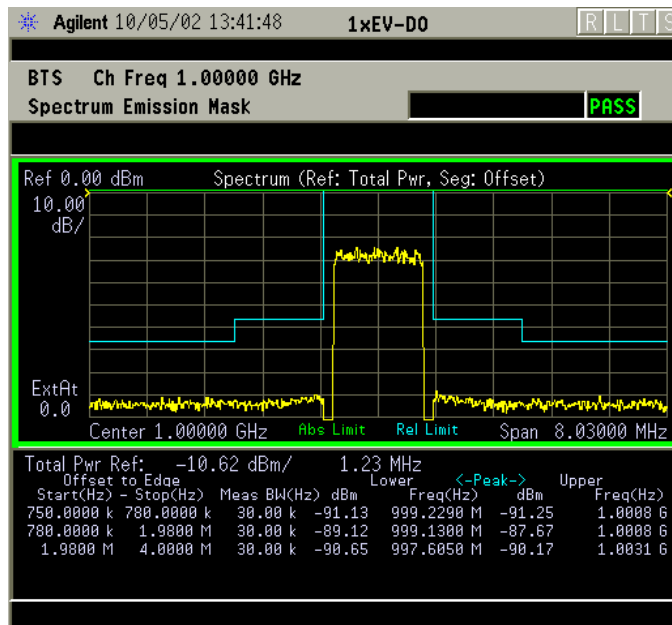
\*Input signal:   -10.00 dBm, Full slot, 1xEV-DO

- **Region A** through **Region E** - Each of spurious emissions measurement results, up to 5 sets of regions, is shown in the graph window. Each region label set to **Off** is grayed out.

**NOTE**

When **Meas Mode** is set to **ACP**, the display appears as shown in [Figure 3-31](#).

**Figure 3-31** Spurious Emissions and ACP Measurement - ACP Mode View



- \*Tester: Meas Mode = ACP,  
Others = Factory default settings
- \*Input signal: -10.00 dBm, Full slot, 1xEV-DO

### Display Key Menu

Key Path: **Spurious Emissions & ACP, Display**

- **Limit Lines** - Allows you to toggle the limit lines display function for spurious emissions or ACP measurements between **On** and **Off**. When set to **On**, the absolute limit lines or the relative limit lines are shown on the measurement display.
- **Abs Peak Pwr & Freq** - Allows you to read the absolute peak power levels in dBm and corresponding frequencies in the text window. This key is disabled when **Spectrum Segment** is set to **Region**.
- **Rel Peak Pwr & Freq** - Allows you to read the relative peak power levels in dBc and corresponding frequencies in the text window. This key is disabled when **Spectrum Segment** is set to **Region**.
- **Integrated Power** - Allows you to read the absolute and relative power levels, integrated throughout the bandwidths between the start and stop frequencies, in the text window. This key is disabled when **Spectrum Segment** is set to **Region**.

### AMPLITUDE Y Scale Key Menu

- **Scale/Div** - Allows you to enter a value to change the vertical display sensitivity. The range is 0.10 to 20.00 dB with 0.01 dB resolution.

The default setting is 10.00 dB. However, since the **Scale Coupling** default is **On**, this value is automatically determined by the measurement result. When you set a value manually, **Scale Coupling** automatically changes to **Off**.

- **Ref Value** - Allows you to set a value for the absolute power reference. The range is from -250.00 to 250.00 dBm with 0.01 dB resolution. The default setting is 10.00 dBm. However, since the **Scale Coupling** default is **On**, this value is automatically determined by the measurement result. When you set a value manually, **Scale Coupling** automatically changes to **Off**.
- **Ref Position** - Allows you to set the reference position to either **Top**, **Ctr** (center), or **Bot** (bottom). The default setting is **Top**.
- **Scale Coupling** - Allows you to toggle the scale coupling function between **On** and **Off**. The default setting is **On**. Upon pressing the **Restart** front panel key or the **Restart** softkey under the **Meas Control** menu, the scale coupling function automatically determines the scale per division and reference values based on the measurement results. When you set a value to either **Scale/Div** or **Ref Value** manually, **Scale Coupling** automatically changes to **Off**.

### Marker Key Menu

Key Path: **Spurious Emissions & ACP, Marker**

- **Select 1 2 3 4** - Allows you to activate up to four markers with the corresponding numbers, respectively. The selected number is underlined and its function is defined by pressing the **Function** key. The default is 1.
- **Normal** - Allows you to activate the selected marker to read the time position and amplitude of the marker on the measurement trace, for example. The marker position is controlled by the **RPG** knob.
- **Delta** - Allows you to read the differences in time positions and amplitudes between the selected marker and the next.
- **Function** - Allows you to define the selected marker function to be **Band Power**, **Noise**, or **Off**. The default is **Off**. For measuring **Band Power**, you need to place the **Normal** marker and then place the **Delta** marker.
- **Trace** - Allows you to place the selected marker on the **Spectrum** trace.
- **Off** - Allows you to turn off the selected marker.
- **Shape Diamond** - Allows you to access the menu to define the selected marker shape to be **Diamond**, **Line**, **Square**, or **Cross**. The default is **Diamond**.
- **Marker All Off** - Allows you to turn off all of the markers.

---

**NOTE** The front panel **Search** key performs a peak search when pressed. A marker will automatically be activated at the highest peak.

---

### Troubleshooting Hints

ACP and spurious emissions measurements can reveal the presence of degraded or defective parts in the transmitter section of the UUT. The following are examples of problems which, once indicated by testing, may require further attention:

- Faulty DC power supply control of the transmitter power amplifier
- RF power controller of the pre-power amplifier stage
- I/Q control of the baseband stage
- Reduction in the gain and output power level of the amplifier due to a degraded gain control and/or increased distortion
- Degradation of amplifier linearity and other performance characteristics

Power amplifiers are one of the final stage elements of a base transmitter and play a critical part in meeting the important power and spectral efficiency specifications. Measuring the spectral response of these amplifiers to complex wideband signals is crucial to linking amplifier linearity and other performance characteristics to the stringent system specifications.

### Waveform (Time Domain) Keys

---

**NOTE** You must have selected **Waveform** under the Key Path: **MEASURE** menu to access these menus.

---

#### Measurement Setup Key Menu

Key Path: **Meas Setup**

- **Sweep Time** - Specifies the measurement acquisition time which is used as the length of the time capture record. The range is 1.0  $\mu$ s and 100.0 s, depending upon the resolution bandwidth setting and the available internal memory size for acquisition points.
- **Meas Time** - Specifies the measurement acquisition time which is used as the length of the time capture record. The range is 10 ns and 100.0 s, depending upon the resolution bandwidth setting and the available internal memory size for acquisition points.
- **Res BW** - Sets the measurement bandwidth. The range is 10 Hz to 8 MHz using the Gaussian filter selected from RBW Filter under the Advanced menu, or 10 Hz to 10 MHz using the Flat top filter selected from RBW Filter. A larger bandwidth results in a larger number of

Key Reference  
1xEV-DO Measurement Keys

acquisition points and reduces the maximum value allowed for the sweep time.

- **IF BW** - For PSA Option 122 or 140 only. Sets the measurement bandwidth. In wideband operation the range is 10 kHz to 80 MHz.(Option 122) or 10 kHz to 40 MHz (Option 140). The narrowband range is 10 Hz to 10 MHz. A larger bandwidth results in a larger number of acquisition points and reduces the maximum value allowed for the measurement time.
- **Wideband Setup** configures the wideband hardware path. This functionality is only available with the wideband options (122 or 140, PSA only).
  - **Wideband IF Gain** - Sets the gain for the wideband IF path. You must have selected **IF Path Wide**. Increasing the gain can increase the amplitude of small signals as long as you don't overdrive the hardware
  - **Wideband Filtering** - Accesses the menu to configure several aspects of the wideband filter.
    - Filter Type** - Selects **None** for no filtering, or **Raised Cosine, RRC** (root-raised cosine), **Nyquist, Root Nyquist, Gaussian** and **Flat Top**.
    - Filter Alpha** - Selects the filter alpha.
    - Filter BW** - Selects filter bandwidth. Bandwidth is not entered as a frequency. The value is entered as a ratio of the current instrument sampling rate (i.e. BW/sample rate).
  - **Sample Rate** - Allows arbitrary sample rates with 5 digits of resolution from 12.5 kHz to 100 MHz. Sample rate is coupled with the selected filter shape and bandwidth, and with the maximum available captured data.
  - **Block Size** - This key is for information only. Block size is coupled with the IF bandwidth and the measurement time.
  - **Wideband Advanced** - Accesses the advanced settings for the Option 122 wideband IF hardware path (PSA only).

---

**NOTE**

Parameters under the **Wideband Advanced** key seldom need to be changed. Any changes from the default advanced values may result in invalid measurement data.

---

- ADC Corr** Turning corrections on performs an ADC calibration to reduce the spectral image and applies the corrections.
- IF Flat Corr** turns IF flatness corrections on and off for the Option 122 or 140 wideband IF. This control is independent of the narrowband IF flatness control.



- ❑ **Analog Filter** manually selects the 80 MHz (Opt 122), 40 MHz (Opt 140), or 36 MHz anti-alias filter, which overrides the automatic selection of the bandwidth.
  - ❑ **WB ADC Dither** Toggles the ADC dither function on/off.. The “ADC dither” refers to the introduction of noise to the digitized steps of the analog-to-digital converter; the result is an improvement in amplitude accuracy. The wideband dither control does not affect the ADC dither in the narrowband IF path.
  - ❑ **Trig Interp** This is an advanced function that usually does not need to be changed. During normal operation trigger interpolation is on and the trigger offset is 0 seconds. At low sample rates the trigger interpolation can cause hardware unlock errors, so you may want to turn it off. You must have an external trigger source to use this functionality.
- **Average**
    - **Avg Number** - Changes the number of N averages.
    - **Avg Mode** - Toggles the averaging mode between **Exp** (exponential) and **Repeat**. This selection only effects on the averaging result after the number of N averages is reached. The N is set using the **Avg Number** key.
      - **Normal averaging:** Normal (linear) averaging is always used until the specified number of N averages is reached. When the **Measure** key under **Meas Control** is set to **Single**, data acquisition is stopped when the number of N averages is reached, thus **Avg Mode** has no effect in the single measurement mode.
      - **Exponential averaging:** When **Measure** is set to **Cont**, data acquisition will continue indefinitely. Exponential averaging is used with a weighting factor of N (the displayed count of averages stops at N). Exponential averaging weights new data more heavily than old data, which allows tracking of slow-changing signals. The weighting factor N is set using the **Avg Number** key.
      - **Repeat averaging:** When **Measure** is set to **Cont**, data acquisition will continue indefinitely. After the number of N averages is reached, all previous result data is cleared and the average count displayed is set back to 1. This is equivalent to being in **Measure Single** and pressing the **Restart** key each time the single measurement finishes.
    - **Avg Type** - Accesses the menu of the following average types only for making spectrum (frequency domain) and waveform (time domain) measurements:

Key Reference  
1xEV-DO Measurement Keys

- ❑ **Pwr Avg (RMS)** - Executes the true power averaging which is calculated by averaging the rms voltage. This is the most accurate type.
  - ❑ **Log-Pwr Avg (Video)** - Simulates the traditional spectrum analyzer type of averaging by calculating the log of the power. This type of averaging will underestimate the power when the signal is noise-like.
  - ❑ **Voltage Avg** - Executes voltage averaging.
  - ❑ **Maximum** - Captures peak voltage data. Simulates the traditional spectrum analyzer peak hold function.
  - ❑ **Minimum** - Captures the minimum voltage data, similar to the maximum function.
- **Time Avg Num** - Changes the number of time averages to be made when using the Option 122 or 140 wideband hardware (PSA only). This averaging requires a frame trigger and is much faster than the standard averaging. This hardware averaging is done on the complex voltage time trace data before any measurement application averaging is done. Both types of averaging can be done on the same measurement data.

When time averaging is being done, each trace update represents N fresh data acquisitions averaged together, where N is the number of averages. You cannot access the individual time records that are being averaged in the hardware averager.

---

**CAUTION** If triggering is set incorrectly, averaged signal results can approach nil. “HW Average” is displayed when averaging is ON.

---

**TIP** If your measurement results vary or provide unexpected values, try turning Averaging OFF and execute single, non-averaged measurements to check your triggering setup. Press **Meas Control, Measure, Single** to make non-continuous measurements.

---

- **Trig Source**  
Key path: **Meas Setup, Trig Source**

---

**NOTE** Changing the selection in the **Trig Source** menu alters the trigger source for the selected measurement only.

---

- **Free Run (Immediate)** - A trigger occurs at the time the data is requested, completely asynchronous with the RF or IF signal.
- **Video (Envlp)** - An internal IF envelope trigger that occurs at the absolute threshold level of the IF signal level.
- **RF Burst (Wideband)** - An internal wideband RF burst trigger that

has the automatic level control for burst signals. It triggers at the level that is set relative to the peak RF signal (12 MHz bandwidth) input level. (Not available for Option 122 or 140 when using the wideband IF path.)

- **Ext Front** - Activates the front panel external trigger input (**EXT TRIGGER INPUT**) port. The external signal must be between  $-5.00$  and  $+5.00$  V with 1 or 10 mV resolution.
- **Ext Rear** - Activates the rear-panel external trigger input (**TRIGGER IN**) port. The external signal must be between  $-5.00$  and  $+5.00$  V with 1 or 10 mV resolution.
- **Frame** - Uses the internal frame clock to generate a trigger signal. The clock parameters are controlled under the **Mode Setup** key or the measurement firmware, but not both. Refer to the specific measurement section for details.
- **Line** - Sets the trigger to the internal line mode. Sweep triggers occur at intervals synchronous to the line frequency. See the specific measurement section for details.
- **IF Path** Only for PSA with Option B7J and either Option 122 or 140 installed. Selects either the standard narrowband IF hardware path or the wideband hardware path.
- **Restore Meas Defaults** - Presets only the settings that are specific to the selected measurement by pressing **Meas Setup, More (1 of 2), Restore Meas Defaults**. This will set the measure setup parameters, for the currently selected measurement only, to the factory defaults.
- **(Narrowband) Advanced** Accesses the menu to change the following parameters.

---

**CAUTION**

---

The advanced features should be used only if you are familiar with their operation. Changes from the default values may result in invalid data.

The **Narrowband** key label word is only present if you have Option B7J and either Option 122 or 140 installed. Parameters that are under the **(Narrowband) Advanced** key only affect the standard narrow band IF path. The wideband IF advanced functions are found under the **Wideband Advanced** key.

- **Pre-ADC BPF** - Toggles the pre-ADC bandpass filter function between **On** or **Off**. The default setting is **Off**. The pre-ADC bandpass filter is useful for rejecting nearby signals, so that sensitivity within the span range can be improved by increasing the ADC range gain.
- **RBW Filter** - Toggles the resolution bandwidth filter selection between **Flat** and **Gaussian**. If set to **Gaussian**, the filter provides more even time-domain response, particularly for “bursts”. If set to **Flat**, the filter provides a flatter bandwidth but is less accurate

Key Reference  
1xEV-DO Measurement Keys

for “pulse responses”. A flat top filter also requires less memory and allows longer data acquisition times. For most waveform applications, the Gaussian filter is recommended. The resolution bandwidth range is 10 Hz to 8 MHz using the Gaussian filter or 10 Hz to 10 MHz using the Flat top filter.

- **ADC Range** - Accesses the menu to select one of the ADC ranging functions:
  - Auto** - Automatically adjusts the signal range for optimal measurement results.
  - AutoPeak** - Continuously searches for the highest peak signal.
  - AutoPeakLock** - Adjusts the range for the highest peak signal it identifies. It retains the range settings determined by that peak signal, even when the peak signal is no longer present.
  - Manual** - Accesses the selection menu of values,  $-6$  to  $+24$  dB for E4406A or None to  $+18$  dB for PSA, to set the ADC range level. Also note that manual ranging is best for CW signals.
- **Data Packing** - Selects **Auto** (the default) or the **Short (16 bit)**, **Medium (24 bit)** and **Long (32 bit)** methods of data packing. The short, medium, and long methods are not compatible with all settings and should not be used unless you are familiar with data packing methods. **Auto** is the preferred choice.
  - Auto** - The data packing value most appropriate for current instrument settings is selected automatically.
  - Short (16 bit)** - Select this to pack data every 16 bits.
  - Medium (24 bit)** - Select this to pack data every 24 bits.
  - Long (32 bit)** - Select this to pack data every 32 bits.
- **ADC Dither** - Toggles the ADC dither function between **On** and **Off**. The default setting is **Off**. If set to **On**, the ADC dither refers to the introduction of noise to the digitized steps of the analog-to-digital converter, and results in better amplitude linearity and resolution in low level signals. However, it also results in reduced dynamic range by approximately 3 dB.
- **Decimation** - Toggles the decimation function between **On** and **Off**, and to set the decimation value. Decimation allows longer acquisition times for a given bandwidth by eliminating data points. Long time captures can be limited by the instrument data acquisition memory. Decimation numbers 1 to 4 describe the factor by which the number of points are reduced. The default setting is 1, which results in no data point reduction.

Table 3-16

Waveform (Time Domain) Measurement Defaults

Measurement Parameter	Factory Default Condition
Sweep Time	2.000 ms
Res BW	100.000 kHz
Averaging: Avg Number Avg Mode Avg Type	10; Off Exp Pwr Avg (RMS)
Trig Source	Free Run (Immediate)
IF Path (requires Option B7J and Option 122 or 140)	Narrow
Wideband IF Gain (Option 122 or 140)	0.00 dB
Wideband Filtering (Option 122 or 140) Filter Type Filter Alpha Filter BW	None 0.30 0.50
<b>Signal Envelope View</b> SPAN X Scale - Scale/Div AMPLITUDE Y Scale - Scale/Div	<b>(for E4406A)</b> 200.0 $\mu$ s 10.00 dB
<b>RF Envelope View</b> SPAN X Scale - Scale/Div AMPLITUDE Y Scale - Scale/Div	<b>(for PSA)</b> 200.0 $\mu$ s 10.00 dB
<b>I/Q Waveform View:</b> SPAN X Scale -Scale/Div AMPLITUDE Y Scale - Scale/Div	200.0 $\mu$ s 100.0 mV
<b>I/Q Polar View:</b> I/Q Scale/Div I or Q Origin	<b>(for E4406A)</b> 100.0 mV 0.00 V
<b>(Narrowband) Advanced</b>	
Pre-ADC BPF	Off
RBW Filter	Gaussian
ADC Range	Auto
Data Packing	Auto
ADC Dither	Off
Decimation	Off
<b>Wideband Advanced</b> (Option 122 or 140)	

Table 3-16

**Waveform (Time Domain) Measurement Defaults**

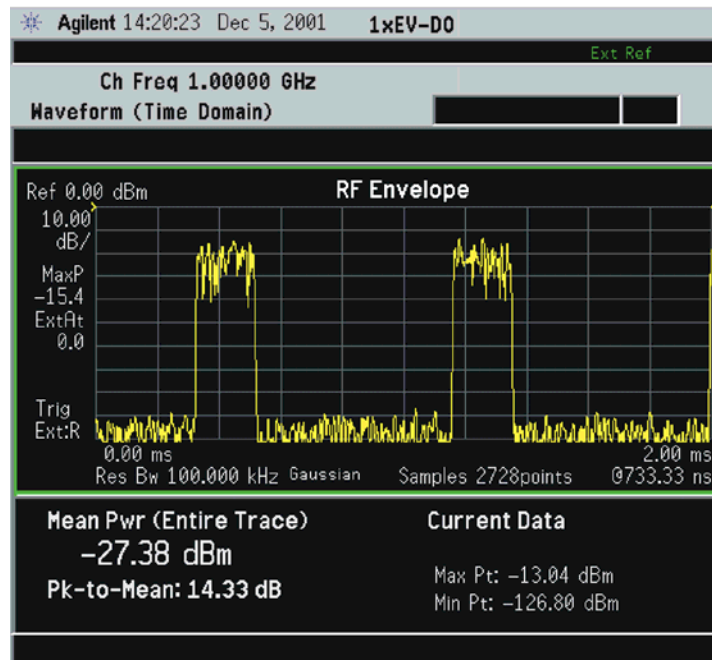
<b>Measurement Parameter</b>	<b>Factory Default Condition</b>
ADC Correction	On
IF Flatness Corrections	On
Analog Filter	Auto, 80 MHz (Opt 122), 40 MHz (Opt 140)
WB ADC Dither	On
Trigger Interpolation	On

## View/Trace Key Menu

Key Path: **View/Trace**

- **RF Envelope** (for E4406A) or **Signal Envelope** (for PSA) - Displays a time domain graph of the signal. The measured values for the mean power and peak-to-mean power are shown in the text window.

**Figure 3-32** Waveform Measurement - RF Envelope (Default View)



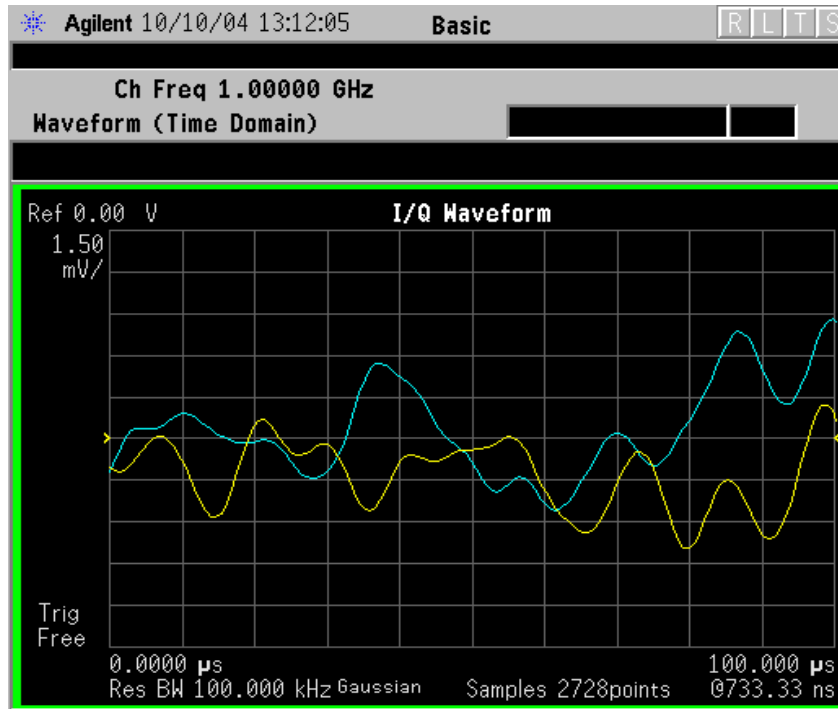
\*Meas Setup: View/Trace = RF Envelope,  
Trigger Source = Ext Rear,  
Others = Factory default settings

\*Input signal: -10 dBm, Idle slot, 1xEV-DO

- **Linear Envelope** - (for E4406A Option B7C) Provides a combination view of a linear signal envelope graph and a phase graph with linear graticules. Use the **Next Window** and **Zoom** keys to select and enlarge either graph.
- **I/Q Waveform** - Provides a view of the I and Q waveforms together on the same graph in parameters of voltage versus time in linear scale. Changes to sweep time or resolution bandwidth can affect data acquisition.

Figure 3-33

## Waveform Measurement - I/Q Waveform View

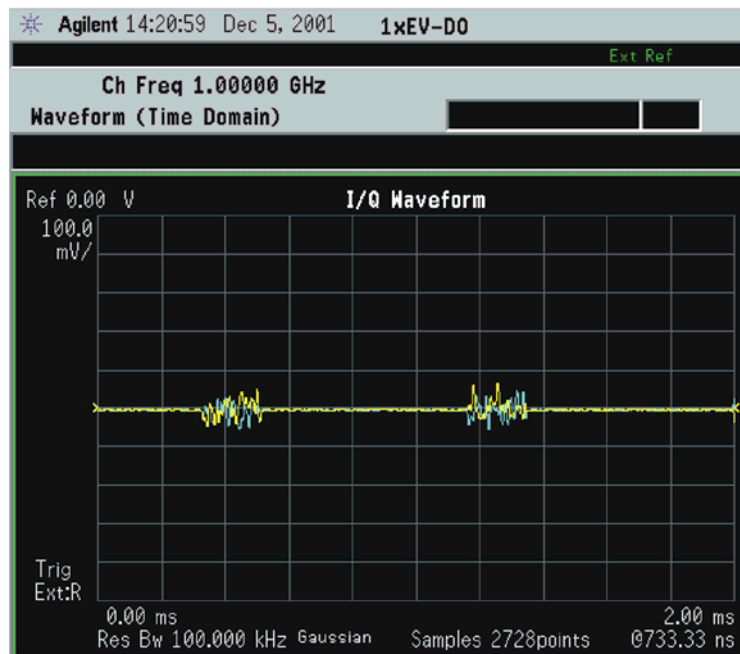


## NOTE

For the widest spans, the I/Q Waveform window becomes just “ADC time domain samples”, because the I/Q down-conversion is no longer in effect.

Figure 3-34

## Waveform Measurement - I/Q Waveform View



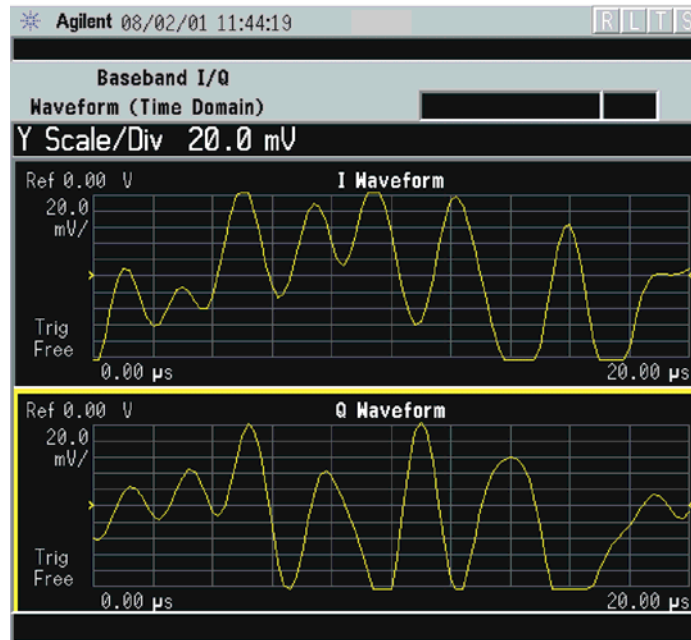


\*Meas Setup: View/Trace = I/Q Waveform,  
Trigger Source = Ext Rear,  
Others = Factory default settings

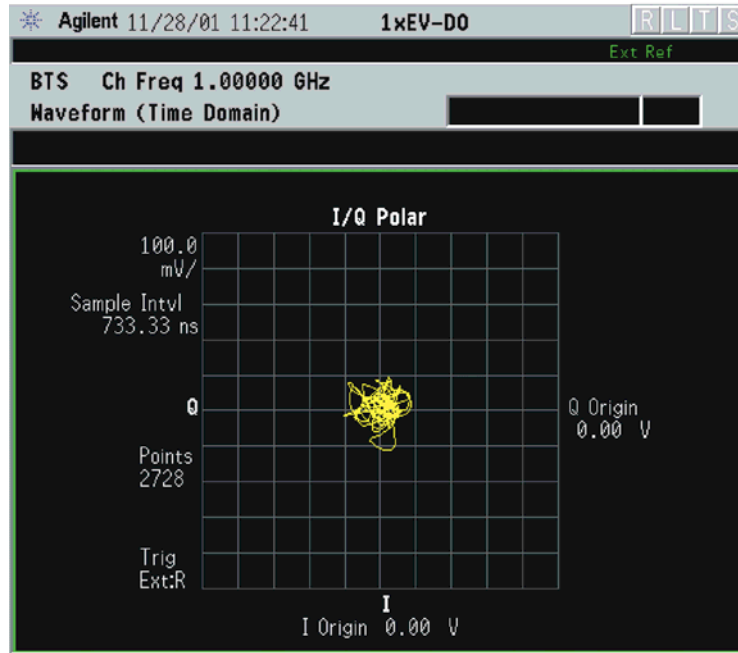
\*Input signal: -10 dBm, Idle slot, 1xEV-DO

- **I and Q Waveform** - (for E4406A Option B7C) Provides a combination view of the I and Q signal waveform graphs in the linear scales.

**Figure 3-35** Waveform Measurement - I and Q Waveform View



- **I/Q Polar** - (for E4406A) Provides a view of the I/Q signal in a polar vector graph.

**Figure 3-36** Waveform Measurement - I/Q Polar View

\*Meas Setup: View/Trace = I/Q Polar,  
Trigger Source = Ext Rear,  
Others = Factory default settings

\*Input signal: -10 dBm, Idle slot, 1xEV-DO

- **Trace Display** - Press this key to access the trace selection menu. The currently selected trace type is shown on the **Trace Display** key.
  - **All** - Views both the current trace and the average trace.
  - **Average** - Views only the average trace (in blue color). See the **Meas Setup**, **Average** keys to select different types of averaging.
  - **Current** - Views only the trace (in yellow color) for the latest data acquisition.
  - **I Trace** - (for E4406A) Views only the I signal trace.
  - **Q Trace** - (for E4406A) Views only the Q signal trace.

### SPAN X Scale Key Menu

Key Path: **Span X Scale**

#### NOTE

The **SPAN X Scale** key accesses the menu to modify the horizontal parameters common to the scaled windows for this measurement. Use the **Sweep Time** key under the **Meas Setup** menu to control the horizontal time span for this measurement:

- **Scale/Div** - Sets the horizontal scale by changing a time value per division. The range is 1.0 ns to 1.000 s per division with 0.01 ns

resolution. The default setting is 200.0  $\mu$ s per division. However, since the **Scale Coupling** default is **On**, this value is automatically determined by the measurement result. When you set a value manually, **Scale Coupling** automatically changes to **Off**.

- **Ref Value** - Sets the reference value ranging from  $-1.0$  to  $10.0$  s. The default setting is  $0.00$  s. However, since the **Scale Coupling** default is **On**, this value is automatically determined by the measurement result. When you set a value manually, **Scale Coupling** automatically changes to **Off**.
- **Ref Position** - Sets the reference position to either **Left**, **Ctr** (center) or **Right**. The default setting is **Left**.
- **Scale Coupling** - Toggles the scale coupling function between **On** and **Off**. The default setting is **On**. Upon pressing the **Restart** front-panel key or **Restart** softkey under the **Meas Control** menu, this function automatically determines the scale per division and reference values based on the measurement results. When you set a value to either **Scale/Div** or **Ref Value** manually, **Scale Coupling** automatically changes to **Off**.

---

**NOTE**

---

For E4406A, if the I/Q Polar window is active in the I/Q Polar view, the **SPAN X Scale** key accesses the following menu:

- **I/Q Scale/Div** - Sets the vertical and horizontal scales by changing a value per division. The range is  $1.00$  nV to  $20.00$  V per division. The default setting is  $100.0$  mV.
- **I or Q Origin** - Sets the reference value ranging from  $-250.00$  to  $250.00$  V. The default setting is  $0.00$  V.

## AMPLITUDE Y Scale Key Menu

Key Path: **AMPLITUDE Y Scale**

---

### NOTE

If the **RF Envelope** (for PSA) or **Signal Envelope** (for E4406A) window is active in the **RF Envelope** (for PSA) or **Signal Envelope** (for E4406A) view, the **AMPLITUDE Y Scale** key accesses the following menu:

- **Scale/Div** - Sets the vertical scale by changing an amplitude value per division. The range is 0.10 to 20.00 dB per division with 0.01 dB resolution. The default setting is 10.00 dB per division. However, since the **Scale Coupling** default is **On**, this value is automatically determined by the measurement result. When you set a value manually, **Scale Coupling** automatically changes to **Off**.
- **Ref Value** - Sets the reference value ranging from -250.00 to 250.00 dBm. The default setting is 0.00 dBm. However, since the **Scale Coupling** default is **On**, this value is automatically determined by the measurement result. When you set a value manually, **Scale Coupling** automatically changes to **Off**.
- **Ref Position** - Sets the reference position to either **Top**, **Ctr** (center) or **Bot** (bottom). The default setting is **Top**.
- **Scale Coupling** - Toggles the scale coupling function between **On** and **Off**. The default setting is **On**. Upon pressing the **Restart** front-panel key or **Restart** softkey under the **Meas Control** menu, this function automatically determines the scale per division and reference values based on the measurement results. When you set a value to either **Scale/Div** or **Ref Value** manually, **Scale Coupling** automatically changes to **Off**.

---

### NOTE

For E4406A with Option B7C, if the **Linear Envelope** window is active in the **Linear Envelope** view, the **AMPLITUDE Y Scale** key accesses the following menu:

- **Scale/Div** - Sets the vertical scale by changing an amplitude value per division. The range is 1.00 nV to 20.00 V per division. The default setting is 100.0 mV per division. However, since the **Scale Coupling** default is **On**, this value is automatically determined by the measurement result. When you set a value manually, **Scale Coupling** automatically changes to **Off**.
- **Ref Value** - Sets the reference value ranging from -250.00 to 250.00 V. The default setting is 0.00 V. However, since the **Scale Coupling** default is **On**, this value is automatically determined by the measurement result. When you set a value manually, **Scale Coupling** automatically changes to **Off**.
- **Ref Position** - Sets the reference position to either **Top**, **Ctr** (center) or **Bot** (bottom). The default setting is **Top**.

- **Scale Coupling** - Toggles the scale coupling function between **On** and **Off**. The default setting is **On**. Upon pressing the **Restart** front-panel key or **Restart** softkey under the **Meas Control** menu, this function automatically determines the scale per division and reference values based on the measurement results. When you set a value to either **Scale/Div** or **Ref Value** manually, **Scale Coupling** automatically changes to **Off**.

---

NOTE

For E4406A with Option B7C, if the **Phase** window is active in the **Linear Envelope** view, the **AMPLITUDE Y Scale** key accesses the menu to modify the following parameters:

- **Scale/Div** - Sets the vertical scale by changing an amplitude value per division. The range is 0.10 to 3600.0 deg per division. The default setting is 30.00 deg. However, since the **Scale Coupling** default is **On**, this value is automatically determined by the measurement result. When you set a value manually, **Scale Coupling** automatically changes to **Off**.
- **Ref Value** - Sets the reference value ranging from -36000.0 to 36000.0 deg. The default setting is 0.00 deg. However, since the **Scale Coupling** default is **On**, this value is automatically determined by the measurement result. When you set a value manually, **Scale Coupling** automatically changes to **Off**.
- **Ref Position** - Sets the reference position to either **Top**, **Ctr** (center) or **Bot** (bottom). The default setting is **Ctr**.
- **Scale Coupling** - Toggles the scale coupling function between **On** and **Off**. The default setting is **On**. Upon pressing the **Restart** front-panel key or **Restart** softkey under the **Meas Control** menu, this function automatically determines the scale per division and reference values based on the measurement results. When you set a value to either **Scale/Div** or **Ref Value** manually, **Scale Coupling** automatically changes to **Off**.

---

NOTE

If the **I/Q Waveform** window is active in the **I/Q Waveform** view, the **AMPLITUDE Y Scale** key accesses the menu to modify the following parameters:

- **Scale/Div** - Sets the vertical scale by changing an amplitude value per division. The range is 1.00 nV to 20.00 V per division. The default setting is 100.0 mV. However, since the **Scale Coupling** default is **On**, this value is automatically determined by the measurement result. When you set a value manually, **Scale Coupling** automatically changes to **Off**.
- **Ref Value** - Sets the reference value ranging from -250.00 to 250.00 V. The default setting is 0.00 V. However, since the **Scale Coupling** default is **On**, this value is automatically determined by the

## Key Reference

### 1xEV-DO Measurement Keys

measurement result. When you set a value manually, **Scale Coupling** automatically changes to **Off**.

- **Ref Position** - Sets the reference position to either **Top**, **Ctr** (center) or **Bot** (bottom). The default setting is **Ctr**.
- **Scale Coupling** - Toggles the scale coupling function between **On** and **Off**. The default setting is **On**. Upon pressing the **Restart** front-panel key or **Restart** softkey under the **Meas Control** menu, this function automatically determines the scale per division and reference values based on the measurement results. When you set a value to either **Scale/Div** or **Ref Value** manually, **Scale Coupling** automatically changes to **Off**.

---

#### NOTE

For E4406A, if the I/Q Polar window is active in the **I/Q Polar** view, the **SPAN X Scale** or **AMPLITUDE Y Scale** key accesses the menu to modify the following parameters:

---

- **I/Q Scale/Div** - Sets the vertical and horizontal scales by changing a value per division. The range is 1.00 nV to 20.00 V per division. The default setting is 100.0 mV.
- **I or Q Origin** - Sets the reference value ranging from -250.00 to 250.00 V. The default setting is 0.00 V.

#### Display Key Menu

The **Display** key is not available for this measurement.

#### Marker Key Menu

Key Path: **Marker**

The **Marker** front-panel key accesses the menu to configure the markers.

- **Select 1 2 3 4** - Activates up to four markers with the corresponding numbers, respectively. The selected number is underlined and its function is defined by pressing the **Function** key. The default is 1.
- **Normal** - Activates the selected marker to read the time position and amplitude of the marker on the RF envelope or Signal Envelope trace. Marker position is controlled by the **RPG** knob.
- **Delta** - Reads the differences in frequency and either time position or amplitude, between the selected marker and the next marker.
- **Function Off** - Selects the marker function to be **Band Power**, **Noise**, or **Off**. The default is **Off**. If set to **Band Power**, you need to select **Delta**.
- **Trace** - Places the selected marker on **RF Envelope** (for PSA), **Signal Envelope** (for E4406A), or **I/Q Waveform**. Also, for E4406A with Option B7C, you can place the marker on **Linear Envelope**, **Linear Phase**, **I Waveform**, or **Q Waveform**.

- **Off** - Turns off the selected marker.
- **Shape Diamond** - Accesses the menu to define the selected marker shape to be **Diamond**, **Line**, **Square**, or **Cross**. The default shape is **Diamond**.
- **Marker All Off** - Turns off all of the markers.

### Peak Search Key

Key Path: **Search**

The front panel **Search** key performs a peak search when pressed. A marker will automatically be activated at the highest peak.

---

#### NOTE

In the Waveform measurement, the Mean Pwr (Entire Trace) value plus the Pk-to-Mean value will sum to equal the current Max Pt. value as shown in the data window below the RF Envelope or Signal Envelope display. If you do a marker peak search (**Search**) with averaging turned off, the marker will find the same maximum point. However, if you turn averaging on, the Pk-to-Mean value will use the highest peak found for any acquisition during averaging, while the marker peak will look for the peak of the display, which is the result of n-averages. This will usually result in differing values for the maximum point.

---

Key Reference  
**1xEV-DO Measurement Keys**



---

## 4 Programming Commands

These commands are only available when the 1xEV-DO mode has been selected using **INSTRument:SElect CDMA1xEV**. If this mode is selected, commands that are unique to another mode are not available.

## **SCPI Command Subsystems**

- “CALCulate Subsystem” on page 296
- “CONFigure Subsystem” on page 352
- “DISPlay Subsystem” on page 353
- “FETCh Subsystem” on page 367
- “FORMat Subsystem” on page 368
- “INITiate Subsystem” on page 370
- “INSTrument Subsystem” on page 372
- “MEASure Group of Commands” on page 375
- “READ Subsystem” on page 438
- “SENSe Subsystem” on page 439
- “TRIGger Subsystem” on page 577

## Programming Command Compatibility Across Model Numbers and Across Modes

### Across PSA Modes: Command Subsystem Similarities

When you select different modes you get different sets of available programming commands. That is, *only* the commands that are appropriate for the current mode are available. Also, some commands have the same syntax in different modes but have different ranges or settings that are only appropriate to the current mode.

The following table shows which command subsystems are the same across different modes. If there is no “X” by a particular subsystem, then the set of available commands is different in those modes. Command ranges or defaults may also be different. Refer to the programming command descriptions in the documentation for each mode for details.

Command Subsystem	Same command set is available:	Same command set is available:
	<b>SA mode compared with the application modes: Digital Modulation, Basic, WLAN, W-CDMA, cdmaOne, cdma2000, 1xEV-DO, GSM, EDGE, NADC, or PDC</b>	<b>SA mode compared with the application modes: Phase Noise, Noise Figure, TD-SCDMA</b>
IEEE common commands	X	X
ABORt	X	X
CALCulate		
CALibration	X	X
CONFigure		
COUPle	not available in these application modes	not available in these application modes
DISPlay		
FETCh		
FORMat		X
HCOPy	X	X
INITiate		
INPut	not available in these application modes	X

Command Subsystem	Same command set is available:  SA mode compared with the application modes: Digital Modulation, Basic, WLAN, W-CDMA, cdmaOne, cdma2000, 1xEV-DO, GSM, EDGE, NADC, or PDC	Same command set is available:  SA mode compared with the application modes: Phase Noise, Noise Figure, TD-SCDMA
MEASure		
MEMory	X	X
MMEMory	X	X
MMEMory:STORE:TRACe	not available in these application modes	X
READ		
[SENSe] [SENSe:]CHANnel [SENSe:]CORRection [SENSe:]FEED [SENSe:]FREQuency:CE NTer [SENSe:]FREQuency: <other subsystems> [SENSe:]<measurement> [SENSe:]POWer [SENSe:]RADio [SENSe:]SYNC	X     not available in these application modes	     not available in these application modes
STATus	X	X
SYSTem	X	X
TRACe	not available in these application modes	X
TRIGger		
UNIT	X	X

## Across PSA Modes: Specific Command Differences

Some programming commands operate differently depending on which Mode the analyzer is set to.

Command	Spectrum Analysis, Phase Noise and Noise Figure Mode	Basic, cdmaOne, cdma2000, 1xEV-DO, W-CDMA, GSM, EDGE, NADC, PDC Modes
CONFigure: <measurement>	Accesses the measurement and sets the instrument settings to the defaults. Averaging is turned on and set to 10. The instrument is put in single measurement mode. It does not initiate a measurement. Use INIT:IMM to make one measurement.	Accesses the measurement and sets the instrument settings to the defaults. If you were already in single measurement mode, it takes one measurement and then waits. If you were in continuous measurement mode it continues to measure.
*ESE default	Default is 255 which means that every error/status bit change that has occurred will be returned with a *ESR? query. You must set the value of *ESE to choose only the bits/status that you want returned.	Default is 0 which means that none of the error/status bit changes that have occurred will be returned with a *ESR? query. You must set the value of *ESE to choose the bits/status that you want returned.
TRIGger commands	For these modes, only one trigger source can be selected and it will be common across the modes. Also, only one value can be set for the trigger delay, level, or polarity.	For these modes, a unique trigger source can be selected for each mode. Also, each trigger source can have unique settings for the its delay, level, and polarity.
Saving and recalling traces	Traces can only be saved when in the Spectrum Analysis mode (MMEM:STOR:TRAC). This is because the instrument state must be saved along with the trace data and the state data varies depending on the number of modes currently available in the instrument.	

## Using Applications in PSA Series vs. VSA E4406A

## NOTE

This information *only* applies to the application modes:

Basic, cdmaOne, cdma2000, 1xEV-DO, W-CDMA, GSM, EDGE, NADC, and PDC.

Command	PSA Series	VSA E4406A: A.04.00	VSA E4406A: A.05.00
*RST	Resets instrument, putting it in continuous measurement mode. Use INIT:CONT OFF to select single measurement mode and INIT:IMM to start one measurement.	Resets instrument, putting it in single measurement mode. One measurement is initiated when the command is sent.	Resets instrument, putting it in single measurement mode. No measurement is initiated when the command is sent. Use INIT:IMM to start one measurement.
CONFigure: <measurement>	Accesses the measurement and sets the instrument settings to the defaults. If you were already in single measurement mode, it takes one measurement and then waits.	Same as PSA. Accesses the measurement and sets the instrument settings to the defaults. If you were already in single measurement mode, it takes one measurement and then waits.	Accesses the measurement and sets the instrument settings to the defaults. If you were already in single measurement mode, it does not initiate a measurement. Use INIT:IMM to make one measurement.
*ESE default	Default is 255 which means that every error/status bit change that has occurred will be returned with a *ESR? query. You must set the value of *ESE to choose only the bits/status that you want returned.	Default is 0 which means that none of the error/status bit changes that have occurred will be returned with a *ESR? query. You must set the value of *ESE to choose the bits/status that you want returned.	Same as VSA A.04.00. Default is 0 which means that none of the error/status bit changes that have occurred will be returned with a *ESR? query. You must set the value of *ESE to choose the bits/status that you want returned.
*LRN	The command is <i>not</i> available.	The command is available.	The command is available.

Command	PSA Series	VSA E4406A: A.04.00	VSA E4406A: A.05.00
TRIGger commands	<p>In Spectrum Analysis mode only one value can be set for the trigger's source, delay, level, or polarity.</p> <p>Basic, GSM, EDGE, cdmaOne, cdma2000, W-CDMA, NADC, PDC modes function the same as VSA</p>	<p>You can select a unique trigger source for each mode. Each trigger source can have unique settings for the its delay, level, and polarity.</p>	<p>Same as VSA A.04.00.</p> <p>You can select a unique trigger source for each mode. Each trigger source can have unique settings for the its delay, level, and polarity.</p>
AUTO ON   OFF control and setting manual values	<p>We recommend that you set a function's automatic state to OFF, before you send it your manual value.</p> <p>Some functions will turn off the automatic mode when you send a specific manual value, but others will not. This also varies with the instrument model.</p>	<p>We recommend that you set a function's automatic state to OFF, before you send it your manual value.</p> <p>Some functions will turn off the automatic mode when you send a specific manual value, but others will not. This also varies with the instrument model.</p>	<p>We recommend that you set a function's automatic state to OFF, before you send it your manual value.</p> <p>Some functions will turn off the automatic mode when you send a specific manual value, but others will not. This also varies with the instrument model.</p>

---

## CALCulate Subsystem

This subsystem is used to perform post-acquisition data processing. In effect, the collection of new data triggers the CALCulate subsystem. In this instrument, the primary functions in this subsystem are markers and limits.

The SCPI default for data output format is ASCII. The format can be changed to binary with FORMat:DATA which transports faster over the bus.

### Test Current Results Against all Limits

**:CALCulate:CLIMits:FAIL?**

Queries the status of the current measurement limit testing. It returns a 0 if the measured results pass when compared with the current limits. It returns a 1 if the measured results fail any limit tests.

### Data Query

**:CALCulate:DATA[n]?**

Returns the designated measurement data for the currently selected measurement and sub-opcode.

n = any valid sub-opcode for the current measurement. See the [“MEASure Group of Commands” on page 375](#) for information on the data that can be returned for each measurement.

For sub-opcodes that return trace data use the :CALCulate:DATA[n]:COMPRESS? command below.

### Calculate/Compress Trace Data Query

**:CALCulate:DATA<n>:COMPRESS? BLOCK|CFIT|MAXimum|MEAN  
|MINimum|RMS|SAMPLE|SDEVIation[,<soffset>[,<length>[,<roffset>[,<rlimit>]]]]**

Returns compressed data for the specified trace data. The data is returned in the same units as the original trace and only works with the currently selected measurement. The command is used with a sub-opcode <n> since measurements usually return several types of trace data. See the following table for the sub-opcodes for the trace data names that are available in each measurement. For sub-opcodes that return scalar data use the :CALCulate:DATA[n]? command above.



This command is used to compress or decimate a long trace to extract and return only the desired data. A typical example would be to acquire N frames of GSM data and return the mean power of the first burst in each frame. The command can also be used to identify the best curve fit for the data.

**BLOCK** or block data - returns all the data points from the region of the trace data that you specify. For example, it could be used to return the data points of an input signal over several timeslots, excluding the portions of the trace data that you do not want.

**CFIT** or curve fit - applies curve fitting routines to the data. <soffset> and <length> are required to define the data that you want. <roffset> is an optional parameter for the desired order of the curve equation. The query will return the following values: the x-offset (in seconds) and the curve coefficients ((order + 1) values).

**MAX**, **MEAN**, **MIN**, **RMS**, **SAMP**, and **SDEV** return one data value for each specified region (or <length>) of trace data, for as many regions as possible until you run out of trace data (using <roffset> to specify regions). Or they return the number regions you specify (using <rlimit>) ignoring any data beyond that.

**MAXimum** - returns the maximum data point for the specified region(s) of trace data. For I/Q trace data, the maximum magnitude of the I/Q pairs is returned.

**MEAN** - returns the arithmetic mean of the data point values for the specified region(s) of trace data. For I/Q trace data, the mean of the magnitudes of the I/Q pairs is returned. Note: If the original trace data is in dB, this function returns the arithmetic mean of those log values, not log of the mean power, which is a more useful value.

**MINimum** - returns the minimum data point for the specified region(s) of trace data. For I/Q trace data, the minimum magnitude of the I/Q pairs is returned.

**RMS** - returns the arithmetic rms of the data point values for the specified region(s) of trace data. For I/Q trace data, the rms of the magnitudes of the I/Q pairs is returned. Note: This function is very useful for I/Q trace data. However, if the original trace data is in dB, this function returns the rms of the log values which is not usually needed.

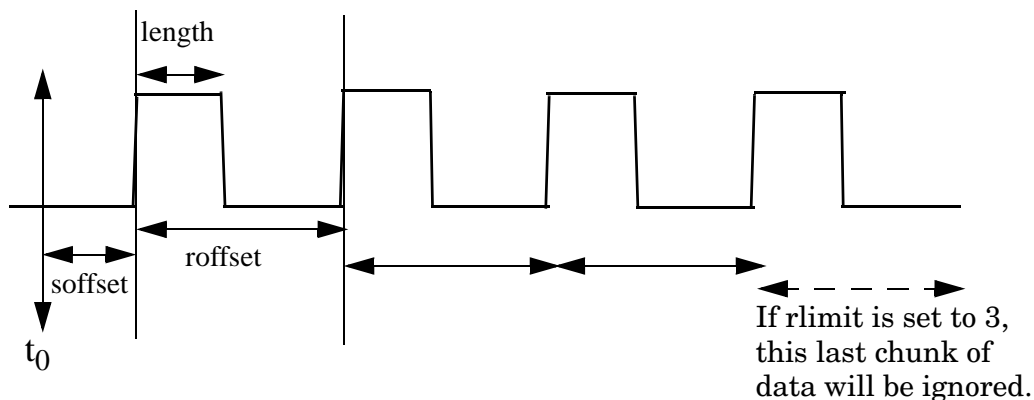
Once you have the rms value for a region of I/Q trace data, you may want to calculate the mean power. You must convert this rms I/Q value (peak volts) to power in dB.

$$10 \times \log[10 \times (\text{rms value})^2]$$

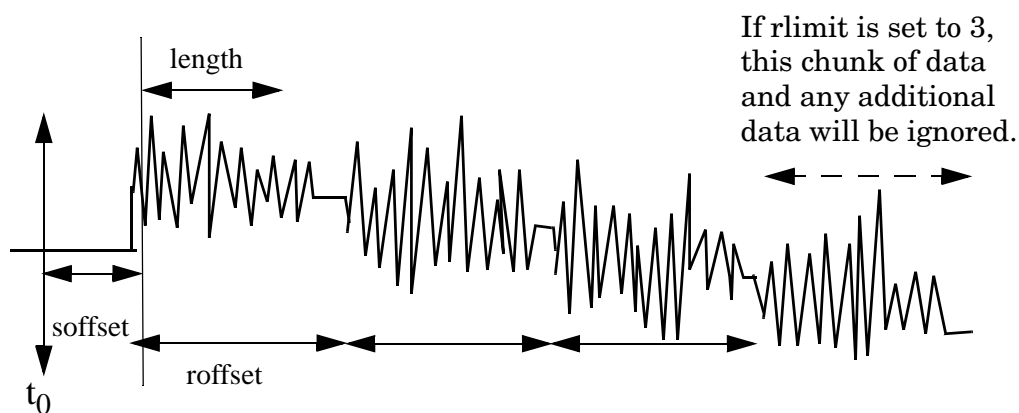
**SAMPle** - returns the first data value for the specified region(s) of trace data. For I/Q trace data, the first I/Q pair is returned.

**SDEVIation** - returns the arithmetic standard deviation for the data point values for the specified region(s) of trace data. For I/Q trace data, the standard deviation of the magnitudes of the I/Q pairs is returned.

**Figure 4-1 Sample Trace Data - Constant Envelope**



**Figure 4-2 Sample Trace Data - Not Constant Envelope**



**<soffset>** - start offset is an optional real number (in seconds). It specifies the amount of data at the beginning of the trace that will be ignored before the decimation process starts. It is the time from the start of the trace to the point where you want to start using the data. The default value is zero.

**<length>** - is an optional real number (in seconds). It defines how much data will be compressed into one value. This parameter has a default value equal to the current trace length.

**<roffset>** - repeat offset is an optional real number (in seconds). It defines the beginning of the next field of trace elements to be compressed. This is relative to the beginning of the previous field. This parameter has a default value equal to the **<length>** variable.

**<rlimit>** - repeat limit is an optional integer. It specifies the number

of data items that you want returned. It will ignore any additional items beyond that number. You can use the Start offset and the Repeat limit to pick out exactly what part of the data you want to use. The default value is all the data.

**Example:** To query the mean power of a set of GSM bursts:

1. Set the waveform measurement sweep time to acquire at least one burst.
2. Set the triggers such that acquisition happens at a known position relative to a burst.
3. Then query the mean burst levels using, **CALC:DATA2:COMP? MEAN, 24e-6, 526e-6** (These parameter values correspond to GSM signals, where 526e-6 is the length of the burst in the slot and you just want 1 burst.)

---

**NOTE** For PSA there is a more detailed example in the “Improving the Speed of Your Measurements” section in the PSA Series *User’s and Programmer’s Reference*. There is also a sample program in the Programming Fundamentals chapter of that book, and a copy of it is on the documentation CD-ROM.

---

**NOTE** For E4406A there is a more detailed example in the “Improving the Speed of Your Measurements” section in the E4406A *Programmer’s Guide*. There is also a sample program in the Programming Fundamentals chapter of that book, and a copy of it is on the documentation CD-ROM.

---

**Remarks:** The optional parameters must be entered in the specified order. For example, if you want to specify <length>, you must also specify <soffset>.

This command uses the data in the format specified by FORMat:DATA, returning either binary or ASCII data.

**History:** For PSA:  
 Added in revision A.02.00

For E4406A:  
 Added in revision A.03.00  
 Changed in revision A.05.00

Measurement	Available Traces	Markers Available?
ACP - adjacent channel power (Basic, cdmaOne, cdma2000, W-CDMA, iDEN (E4406A only), NADC, PDC modes)	no traces  (n=0) <sup>a</sup> for I/Q points	no markers

Measurement	Available Traces	Markers Available?
BER - bit error rate (iDEN mode, E4406A only)	no traces (n=0) <sup>a</sup> for I/Q data	no markers
CDPower - code domain power (cdmaOne mode)	POWer (n=2) <sup>a</sup> TIMing (n=3) <sup>a</sup> PHASe (n=4) <sup>a</sup> (n=0) <sup>a</sup> for I/Q points	yes
CDPower - code domain power (cdma2000, W-CDMA, 1xEV-DO modes)	CDPower (n=2) <sup>a</sup> EVM (n=5) <sup>a</sup> MERRor (n=6) <sup>a</sup> PERRor (n=7) <sup>a</sup> SPOWer (n=9) <sup>a</sup> CPOWer (n=10) <sup>a</sup> (n=0) <sup>a</sup> for I/Q points	yes
CHPower - channel power (Basic, cdmaOne, cdma2000, W-CDMA, 1xEV-DO modes)	SPECtrum (n=2) <sup>a</sup> (n=0) <sup>a</sup> for I/Q points	no markers
CSPur - spurs close (cdmaOne mode)	SPECtrum (n=2) <sup>a</sup> ULIMit (n=3) <sup>a</sup> (n=0) <sup>a</sup> for I/Q points	yes
EEVM - EDGE error vector magnitude (EDGE mode)	EVMerror (n=2) <sup>a</sup> MERRor (n=3) <sup>a</sup> PERRor (n=4) <sup>a</sup> (n=0) <sup>a</sup> for I/Q points	yes
EORFspectr - EDGE output RF spectrum (EDGE mode)	RFEMod (n=2) <sup>a</sup> RFESwitching (n=3) <sup>a</sup> SPEMod (n=4) <sup>a</sup> LIMMod (n=5) <sup>a</sup> (n=0) <sup>a</sup> for I/Q points	yes, only for a single offset  yes, only for multiple offsets

Measurement	Available Traces	Markers Available?
EPVTime - EDGE power versus time (EDGE mode)	RFENvelope (n=2) <sup>a</sup> UMASk (n=3) <sup>a</sup> LMASk (n=4) <sup>a</sup> (n=0) <sup>a</sup> for I/Q points	yes
ETSPur - EDGE transmit band spurs (EDGE mode)	SPECTrum (n=2) <sup>a</sup> ULIMit (n=3) <sup>a</sup> (n=0) <sup>a</sup> for I/Q points	yes
EVM - error vector magnitude (NADC, PDC modes)	EVM (n=2) <sup>a</sup> MERRor (n=3) <sup>a</sup> PERRor (n=4) <sup>a</sup> (n=0) <sup>a</sup> for I/Q points	yes
EVMQpsk - QPSK error vector magnitude (cdma2000, W-CDMA, 1xEV-DO modes)	EVM (n=2) <sup>a</sup> MERRor (n=3) <sup>a</sup> PERRor (n=4) <sup>a</sup> (n=0) <sup>a</sup> for I/Q points	yes
IM - intermodulation (cdma2000, W-CDMA, 1xEV-DO modes)	SPECTrum (n=2) <sup>a</sup> (n=0) <sup>a</sup> for I/Q points	yes
MCPower - multi-carrier power (W-CDMA mode)	no traces (n=0) <sup>a</sup> for I/Q points	no markers
OBW - occupied bandwidth (cdmaOne, cdma2000, iDEN (E4406A only), PDC, W-CDMA, 1xEV-DO modes)	no traces (n=0) <sup>a</sup> for I/Q points	no markers
ORFSpectrum - output RF spectrum (GSM, EDGE mode)	RFEMod (n=2) <sup>a</sup> RFESwitching (n=3) <sup>a</sup> SPEMod (n=4) <sup>a</sup> LIMMod (n=5) <sup>a</sup> (n=0) <sup>a</sup> for I/Q points	yes, only for a single offset  yes, only for multiple offsets

Measurement	Available Traces	Markers Available?
PCONtrol - power control (W-CDMA mode)	RFENvelope POWEr	yes
PFERror - phase and frequency error (GSM, EDGE mode)	PERRor (n=2) <sup>a</sup> PFERror (n=3) <sup>a</sup> RFENvelope (n=4) <sup>a</sup> (n=0) <sup>a</sup> for I/Q points	yes
PStatistic - power statistics CCDF (Basic, cdma2000, W-CDMA, 1xEV-DO modes)	MEASured (n=2) <sup>a</sup> GAUSSian (n=3) <sup>a</sup> REFerence (n=4) <sup>a</sup> (n=0) <sup>a</sup> for I/Q points	yes
PVTime - power versus time (GSM, EDGE, 1xEV-DO, Service (E4406A only) modes)	RFENvelope (n=2) <sup>a</sup> UMASk (n=3) <sup>a</sup> LMASk (n=4) <sup>a</sup> (n=0) <sup>a</sup> for I/Q points	yes
RHO - modulation quality (cdmaOne, cdma2000, W-CDMA, 1xEV-DO mode)	(n=0) <sup>a</sup> for I/Q points EVM (n=2) <sup>a</sup> MERRor (n=3) <sup>a</sup> PERRor (n=4) <sup>a</sup> (n=0) <sup>a</sup> for I/Q points	yes
SEMask - spectrum emissions mask (cdma2000, W-CDMA, 1xEV-DO mode)	SPECtrum (n=2) <sup>a</sup> (n=0) <sup>a</sup> for I/Q points	yes
TSPur - transmit band spurs (GSM, EDGE mode)	SPECtrum (n=2) <sup>a</sup> ULIMit (n=3) <sup>a</sup> (n=0) <sup>a</sup> for I/Q points	yes
TXPower - transmit power (GSM, EDGE mode)	RFENvelope (n=2) <sup>a</sup> IQ (n=8) <sup>a</sup> (n=0) <sup>a</sup> for I/Q points	yes

Measurement	Available Traces	Markers Available?
SPECTrum - (frequency domain) (all modes)	RFENvelope (n=2) <sup>a</sup> for Service mode (E4406A only)  IQ (n=3) <sup>a</sup>  SPECTrum (n=4) <sup>a</sup>  ASPECTrum (n=7) <sup>a</sup>  (n=0) <sup>a</sup> for I/Q points	yes
WAVEform - (time domain) (all modes)	RFENvelope (n=2) <sup>a</sup> (also for Signal Envelope trace)  IQ (n=5) <sup>a</sup>  (n=0) <sup>a</sup> for I/Q points	yes

- a. The n number indicates the sub-opcode that corresponds to this trace. Detailed descriptions of the trace data can be found in the MEASure subsystem documentation by looking up the sub-opcode for the appropriate measurement.

## Calculate Peaks of Trace Data

**:CALCulate:DATA<n>:PEAKs?**  
**<threshold>, <excursion> [, AMPLitude | FREQuency | TIME]**

Returns a list of peaks for the designated trace data n for the currently selected measurement. The peaks must meet the requirements of the peak threshold and excursion values.

The command can only be used with specific <n> (sub-opcode) values, for measurement results that are trace, or scalar, data. See the table above for the appropriate sub-opcodes. Both real and complex traces can be searched, but complex traces are converted to magnitude in dBm. Sub-opcode n=0, is the raw trace data which cannot be searched for peaks. Sub-opcode n=1, is the scaler data which also cannot be searched for peaks.

Threshold - is the level below which trace data peaks are ignored

Excursion - To be defined as a peak, the signal must rise above the threshold by a minimum amplitude change (excursion). Excursion is measured from the lowest point above the threshold (of the rising edge of the peak), to the highest signal point that begins the falling edge. If a signal valley is higher than the threshold, then the

excursion is referenced to that valley, and a peak is only defined if the signal following that valley exceeds the excursion.

Amplitude - lists the peaks in order of descending amplitude, so the highest peak is listed first. This is the default peak order listing if the optional parameter is not specified.

Frequency - lists the peaks in order of occurrence, left to right across the x-axis

Time - lists the peaks in order of occurrence, left to right across the x-axis

Example: Select the spectrum measurement.

Use **CALC:DATA4:PEAK? -40,10,FREQ** to identify the peaks above -40 dBm, with excursions of at least 10 dB, in order of increasing frequency.

Query Results: Returns a list of floating-point numbers. The first value in the list is the number of peak points that follow. A peak point consists of two values: a peak amplitude followed by the its corresponding frequency (or time).

If no peaks are found the peak list will consist of only the number of peaks, (0).

The peak list is limited to 100 peaks. Peaks in excess of 100 are ignored.

Remarks: This command uses the data setting specified by the **FORMat:DATA** command and can return real 32-bit, real 64-bit, or ASCII data. The default data format is ASCII.

History: For E4406A:  
Added in revision A.03.00 and later



## CALCulate:MARKers Subsystem

Markers can be put on your displayed measurement data to supply information about specific points on the data. Some of the things that markers can be used to measure include: precise frequency at a point, minimum or maximum amplitude, and the difference in amplitude or frequency between two points.

When using the marker commands you must specify the measurement in the SCPI command. We recommend that you use the marker commands only on the current measurement. Many marker commands will return invalid results, when used on a measurement that is not current. (This is true for commands that do more than simply setting or querying an instrument parameter.) No error is reported for these invalid results.

You must make sure that the measurement is completed before trying to query the marker value. Using the MEASure or READ command, before the marker command, forces the measurement to complete before allowing the next command to be executed.

Each measurement has its own instrument state for marker parameters. Therefore, if you exit the measurement, the marker settings in each measurement are saved and are then recalled when you change back to that measurement.

### Basic Mode - <measurement> key words

- ACPr - no markers (E4406A only)
- CHPower - no markers (E4406A only)
- PSTatic - markers available (E4406A only)
- SPECTrum - markers available
- WAVeform - markers available

### Service Mode - <measurement> key words

- PVTime - no markers
- SPECTrum - markers available
- WAVeform - markers available

### 1xEV-DO Mode - <measurement> key words

- CDPower - markers available
- TCDPower - markers available
- CHPower - no markers
- EVMQpsk - markers available

- IM - markers available
- OBW - no markers
- PStatistic - markers available
- PVTime - markers available
- RHO - markers available
- TRHO - markers available
- SEMask - markers available
- SPECTrum - markers available
- WAVEform - markers available

**cdmaOne Mode - <measurement> key words**

- ACPr - no markers
- CHPower - no markers
- CDPower - markers available
- CSPur - markers available
- RHO - markers available
- SPECTrum - markers available
- WAVEform - markers available

**cdma2000 Mode - <measurement> key words**

- ACP - no markers
- CDPower - markers available
- CHPower - no markers
- EVMQpsk - markers available
- IM - markers available
- OBW - no markers
- PStatistic - markers available
- RHO - markers available
- SEMask - markers available
- SPECTrum - markers available
- WAVEform - markers available

**GSM (with EDGE) Mode - <measurement> key words**

- EEVM - markers available
- EORFspectr - markers available
- EPVTime - no markers
- ETSPur - markers available
- ORFSpectrum - markers available
- PFERror - markers available
- PVTime - no markers
- SPECTrum - markers available
- TSPur - markers available
- TXPower - no markers

- WAVEform - markers available

### **GSM Mode - <measurement> key words**

- ORFSpectrum - markers available
- PFERror - markers available
- PVTime - no markers
- SPECTrum - markers available
- TSPur - markers available
- TXPower - no markers
- WAVEform - markers available

### **iDEN Mode - <measurement> key words**

- ACP - no markers
- BER - no markers
- OBW - no markers
- SPECTrum - markers available
- WAVEform - markers available

### **NADC Mode - <measurement> key words**

- ACP - no markers
- EVM - markers available
- SPECTrum - markers available
- WAVEform - markers available

### **PDC Mode - <measurement> key words**

- ACP - no markers
- EVM - markers available
- OBW - no markers
- SPECTrum - markers available
- WAVEform - markers available

### **W-CDMA Mode - <measurement> key words**

- ACP - no markers
- CDPower - markers available
- CHPower - no markers
- EVMQpsk - markers available
- IM - markers available
- MCPower - no markers
- OBW - no markers
- PSTatistic - markers available
- RHO - markers available
- SEMask - markers available

- SPECTrum - markers available
- WAVEform - markers available

### Example:

Suppose you are using the Spectrum measurement in your measurement personality. To position marker 2 at the maximum peak value of the trace that marker 2 is currently on, the command is:

**:CALCulate:SPECTrum:MARKer2:MAXimum**

You must make sure that the measurement is completed before trying to query the marker value. Use the MEASure or READ command before using the marker command. This forces the measurement to complete before allowing the next command to be executed.

### Markers All Off on All Traces

**:CALCulate:<measurement>:MARKer:AOFF**

Turns off all markers on all the traces in the specified measurement.

Example: **CALC:SPEC:MARK:AOFF**

Remarks: The keyword for the current measurement must be specified in the command. (Some examples include: SPECTrum, WAVEform)

Front Panel

Access: **Marker, More, Marker All Off**

### Marker Function Result

**:CALCulate:<measurement>:MARKer[1] | 2 | 3 | 4:FUNCTION:RESult?**

Queries the result of the currently active marker function. The measurement must be completed before querying the marker. A particular measurement may not have all the types of markers available.

The marker must have already been assigned to a trace. Use **:CALCulate:<measurement>:MARKer[1] | 2 | 3 | 4:TRACe** to assign a marker to a particular trace.

Example: **CALC:SPEC:MARK:FUNC:RES?**

Remarks: The keyword for the current measurement must be specified in the command. (Some examples include: SPECTrum, WAVEform)

Front Panel

Access: **Marker, Marker Function**

### Marker Peak (Maximum) Search

**:CALCulate:<measurement>:MARKer[1] | 2 | 3 | 4:MAXimum**

Places the selected marker on the highest point on the trace that is assigned to that particular marker number.

The marker must have already been assigned to a trace. Use **:CALCulate:<measurement>:MARKer [1] | 2 | 3 | 4:TRACe** to assign a marker to a particular trace.

Example: **CALC:SPEC:MARK1:MAX**

Remarks: The keyword for the current measurement must be specified in the command. (Some examples include: SPECTrum, WAVeform)

Front Panel  
Access: **Search**

### Marker Peak (Minimum) Search

**:CALCulate:<measurement>:MARKer[1] | 2 | 3 | 4:MINimum**

Places the selected marker on the lowest point on the trace that is assigned to that particular marker number.

The marker must have already been assigned to a trace. Use **:CALCulate:<measurement>:MARKer [1] | 2 | 3 | 4:TRACe** to assign a marker to a particular trace.

Example: **CALC:SPEC:MARK2 MIN**

Remarks: The keyword for the current measurement must be specified in the command. (Some examples include: SPECTrum, WAVeform)

### Marker Mode

E4406A (all modes):

PSA Series (Basic, cdmaOne, cdma2000, W-CDMA, GSM/EDGE, NADC, PDC modes):

**:CALCulate:<measurement>:MARKer[1] | 2 | 3 | 4:MODE  
POSition | DELTa**

ESA/PSA Series (Phase Noise mode only):

**:CALCulate:<measurement>:MARKer[1] | 2 | 3 | 4:MODE  
POSition | DELTa | RMSDegree |**

## **RMSRadian | RFM | RMSJitter | OFF**

**:CALCulate:<measurement>:MARKer[1] | 2 | 3 | 4:MODE?**

E4406A/PSA: Selects the type of marker to be a normal position-type marker or a delta marker. A specific measurement may not have both types of markers. For example, several measurements only have position markers

ESA/PSA Phase Noise Mode: Selects the type of marker to be a normal position-type marker, a delta marker or an RMS measurement marker.

The marker must have already been assigned to a trace. Use

**:CALCulate:<measurement>:MARKer [1] | 2 | 3 | 4:TRACe** to assign a marker to a particular trace.

Example:       **CALC:SPEC:MARK:MODE DELTA**

Remarks:       For the delta mode only markers 1 and 2 are valid.  
  
                  The keyword for the current measurement must be specified in the command. (Some examples include: SPECTrum, WAVeform)

Front Panel

Access:         **Marker, Marker [Delta]**

## **Marker On/Off**

**:CALCulate:<measurement>:MARKer[1] | 2 | 3 | 4[:STATe]  
OFF | ON | 0 | 1**

**:CALCulate:<measurement>:MARKer[1] | 2 | 3 | 4[:STATe]?**

Turns the selected marker on or off.

The marker must have already been assigned to a trace. Use

**:CALCulate:<measurement>:MARKer [1] | 2 | 3 | 4:TRACe** to assign a marker to a particular trace.

Example:       **CALC:SPEC:MARK2: on**

Remarks:       The keyword for the current measurement must be specified in the command. (Some examples include: SPECTrum, AREFERENCE, WAVeform)  
  
                  The WAVeform measurement only has two markers available.

Front Panel

Access:         **Marker, Select then Marker Normal or Marker On Off**

### Marker to Trace

**:CALCulate:<measurement>:MARKer[1] | 2 | 3 | 4:TRACe  
<trace\_name>**

**:CALCulate:<measurement>:MARKer[1] | 2 | 3 | 4:TRACe?**

Assigns the specified marker to the designated trace. Not all types of measurement data can have markers assigned to them.

**Example:** With the WAVeform measurement selected, a valid command is **CALC:SPEC:MARK2:TRACE rfenvelope**.

**Range:** The names of valid traces are dependent upon the selected measurement. See the following table for the available trace names. The trace name assignment is independent of the marker number.

**Remarks:** The keyword for the current measurement must be specified in the command. (Some examples include: SPECTrum, WAVeform)

Front Panel

Access: **Marker, Marker Trace**

Measurement	Available Traces	Markers Available?
ACP - adjacent channel power (Basic, cdmaOne, cdma2000, W-CDMA, iDEN (E4406A only), NADC, PDC modes)	no traces (n=0) <sup>a</sup> for I/Q points	no markers
BER - bit error rate (iDEN, WiDENmode, E4406A only)	no traces (n=0) <sup>a</sup> for I/Q data	no markers
CDPower - code domain power (cdmaOne mode)	POWer (n=2) <sup>a</sup> TIMing (n=3) <sup>a</sup> PHASe (n=4) <sup>a</sup> (n=0) <sup>a</sup> for I/Q points	yes

Measurement	Available Traces	Markers Available?
CDPower - code domain power (cdma2000, W-CDMA, 1xEV-DO modes)	CDPower (n=2) <sup>a</sup> EVM (n=5) <sup>a</sup> MERRor (n=6) <sup>a</sup> PERRor (n=7) <sup>a</sup> SPOWer (n=9) <sup>a</sup> CPOWer (n=10) <sup>a</sup> (n=0) <sup>a</sup> for I/Q points	yes
CHPower - channel power (Basic, cdmaOne, cdma2000, W-CDMA, 1xEV-DO modes)	SPECtrum (n=2) <sup>a</sup> (n=0) <sup>a</sup> for I/Q points	no markers
CSPur - spurs close (cdmaOne mode)	SPECtrum (n=2) <sup>a</sup> ULIMit (n=3) <sup>a</sup> (n=0) <sup>a</sup> for I/Q points	yes
EEVM - EDGE error vector magnitude (EDGE mode)	EVMerror (n=2) <sup>a</sup> MERRor (n=3) <sup>a</sup> PERRor (n=4) <sup>a</sup> (n=0) <sup>a</sup> for I/Q points	yes
EORFspectr - EDGE output RF spectrum (EDGE mode)	RFEMod (n=2) <sup>a</sup> RFESwitching (n=3) <sup>a</sup> SPEMod (n=4) <sup>a</sup> LIMMod (n=5) <sup>a</sup> (n=0) <sup>a</sup> for I/Q points	yes, only for a single offset  yes, only for multiple offsets
EPVTime - EDGE power versus time (EDGE mode)	RFENvelope (n=2) <sup>a</sup> UMASk (n=3) <sup>a</sup> LMASk (n=4) <sup>a</sup> (n=0) <sup>a</sup> for I/Q points	yes
ETSPur - EDGE transmit band spurs (EDGE mode)	SPECtrum (n=2) <sup>a</sup> ULIMit (n=3) <sup>a</sup> (n=0) <sup>a</sup> for I/Q points	yes



Measurement	Available Traces	Markers Available?
EVM - error vector magnitude (NADC, PDC modes)	EVM (n=2) <sup>a</sup> MERRor (n=3) <sup>a</sup> PERRor (n=4) <sup>a</sup> (n=0) <sup>a</sup> for I/Q points	yes
EVMQpsk - QPSK error vector magnitude (cdma2000, W-CDMA, 1xEV-DO modes)	EVM (n=2) <sup>a</sup> MERRor (n=3) <sup>a</sup> PERRor (n=4) <sup>a</sup> (n=0) <sup>a</sup> for I/Q points	yes
IM - intermodulation (cdma2000, W-CDMA, 1xEV-DO modes)	SPECTrum (n=2) <sup>a</sup> (n=0) <sup>a</sup> for I/Q points	yes
MCPower - multi-carrier power (W-CDMA mode)	no traces (n=0) <sup>a</sup> for I/Q points	no markers
OBW - occupied bandwidth (cdmaOne, cdma2000, iDEN, WiDEN (E4406A only), PDC, W-CDMA, 1xEV-DO modes)	no traces (n=0) <sup>a</sup> for I/Q points	no markers
ORFSpectrum - output RF spectrum (GSM, EDGE mode)	RFEMod (n=2) <sup>a</sup> RFESwitching (n=3) <sup>a</sup> SPEMod (n=4) <sup>a</sup> LIMMod (n=5) <sup>a</sup> (n=0) <sup>a</sup> for I/Q points	yes, only for a single offset  yes, only for multiple offsets
PFERror - phase and frequency error (GSM, EDGE mode)	PERRor (n=2) <sup>a</sup> PFERror (n=3) <sup>a</sup> RFENvelope (n=4) <sup>a</sup> (n=0) <sup>a</sup> for I/Q points	yes
PSTatistic - power statistics CCDF (Basic, cdma2000, W-CDMA, 1xEV-DO modes)	MEASured (n=2) <sup>a</sup> GAUSSian (n=3) <sup>a</sup> REFerence (n=4) <sup>a</sup> (n=0) <sup>a</sup> for I/Q points	yes

Measurement	Available Traces	Markers Available?
PVTime - power versus time (GSM, EDGE, 1xEV-DO, Service (E4406A only) modes)	RFENvelope (n=2) <sup>a</sup> UMASk (n=3) <sup>a</sup> LMASk (n=4) <sup>a</sup> (n=0) <sup>a</sup> for I/Q points	yes
RHO - modulation quality (cdmaOne, cdma2000, W-CDMA, 1xEV-DO mode)	(n=0) <sup>a</sup> for I/Q points EVM (n=2) <sup>a</sup> MERRor (n=3) <sup>a</sup> PERRor (n=4) <sup>a</sup> (n=0) <sup>a</sup> for I/Q points	yes
SEMask - spectrum emissions mask (cdma2000, W-CDMA, 1xEV-DO mode)	SPECtrum (n=2) <sup>a</sup> (n=0) <sup>a</sup> for I/Q points	yes
TSPur - transmit band spurs (GSM, EDGE mode)	SPECtrum (n=2) <sup>a</sup> ULIMit (n=3) <sup>a</sup> (n=0) <sup>a</sup> for I/Q points	yes
TXPower - transmit power (GSM, EDGE mode)	RFENvelope (n=2) <sup>a</sup> IQ (n=8) <sup>a</sup> (n=0) <sup>a</sup> for I/Q points	yes
SPECtrum - (frequency domain) (all modes)	RFENvelope (n=2) <sup>a</sup> for Service mode (E4406A only) IQ (n=3) <sup>a</sup> SPECtrum (n=4) <sup>a</sup> ASpectrum (n=7) <sup>a</sup> (n=0) <sup>a</sup> for I/Q points	yes
WAVEform - (time domain) (all modes)	RFENvelope (n=2) <sup>a</sup> (also for Signal Envelope trace) IQ (n=5) <sup>a</sup> (n=0) <sup>a</sup> for I/Q points	yes

- a. The n number indicates the sub-opcode that corresponds to this trace. Detailed descriptions of the trace data can be found in the MEASure subsystem documentation by looking up the sub-opcode for the appropriate measurement.

### Marker X Value

**:CALCulate:<measurement>:MARKer[1] | 2 | 3 | 4:X <param>**

**:CALCulate:<measurement>:MARKer[1] | 2 | 3 | 4:X?**

Position the designated marker on its assigned trace at the specified X value. The parameter value is in X-axis units (which is often frequency or time).

The marker must have already been assigned to a trace. Use **:CALCulate:<measurement>:MARKer [1] | 2 | 3 | 4:TRACe** to assign a marker to a particular trace.

The query returns the current X value of the designated marker. The measurement must be completed before querying the marker.

Example:       **CALC:SPEC:MARK2:X 1.2e6 Hz**

Range:           For Phase Noise mode: Graph Start Offset and Stop Offset frequencies.

Default Unit:   Matches the units of the trace on which the marker is positioned

Remarks:       The keyword for the current measurement must be specified in the command. (Some examples include: LPLot, ACP, WAVEform)

Front Panel

Access:           **Marker, <active marker>, RPG**

### Marker X Position

**:CALCulate:<measurement>:MARKer[1] | 2 | 3 | 4:X:POSition <integer>**

**:CALCulate:<measurement>:MARKer[1] | 2 | 3 | 4:X:POSition?**

Position the designated marker on its assigned trace at the specified X position. A trace is composed of a variable number of measurement points. This number changes depending on the current measurement conditions. The current number of points must be identified before using this command to place the marker at a specific location.

The marker must have already been assigned to a trace. Use **:CALCulate:<measurement>:MARKer [1] | 2 | 3 | 4:TRACe** to assign a

marker to a particular trace.

The query returns the current X position for the designated marker. The measurement must be completed before querying the marker.

Example:       **CALC:SPEC:MARK:X:POS 500**

Range:         0 to a maximum of (3 to 920,000)

Remarks:      The keyword for the current measurement must be specified in the command. (Some examples include: SPECTrum, WAVeform)

Front Panel

Access:       **Marker, <active marker>, RPG**

### Marker Readout Y Value

**:CALCulate:<measurement>:MARKer[1] | 2 | 3 | 4:Y?**

Readout the current Y value for the designated marker on its assigned trace. The value is in the Y-axis units for the trace (which is often dBm).

The marker must have already been assigned to a trace. Use

**:CALCulate:<measurement>:MARKer [1] | 2 | 3 | 4:TRACe** to assign a marker to a particular trace.

The measurement must be completed before querying the marker.

Example:       **CALC:SPEC:MARK1:Y?**

Default Unit:  Matches the units of the trace on which the marker is positioned

Remarks:      The keyword for the current measurement must be specified in the command. (Some examples include: LPLot, ACP, WAVeform)

## Code Domain Power

### Code Domain—Active Set Threshold

**:CALCulate:CDPower:ASET:THReshold <numeric>**

**:CALCulate:CDPower:ASET:THReshold?**

Set the threshold level for the active channel identification function.

Factory Preset: 0.0 dBm

Range:         -100.0 to 0.0 dB

Remarks:      You must be in the cdma2000, W-CDMA, or 1xEV-DO mode to use this command. Use INSTRument:SElect to

set the mode.

### Code Domain—Active Set Threshold Auto

**:CALCulate:CDPower:ASET:THReshold:AUTO OFF|ON|0|1**

**:CALCulate:CDPower:ASET:THReshold:AUTO?**

Set the threshold value for the active channel detection. The user can set the active channel identification function to either ON (Auto) or OFF (Manual). If set to OFF (Manual), the active channels are determined by :CALCulate:CDPower:ASET:THReshold <numeric>. If set to ON (Auto), the active channel identification is determined automatically by an internal algorithm.

Key Path:	<b>Meas Setup, More 1 of 3, More 2of 3, Advanced</b>
Unit/Terminator	dB
Keys:	
Preset:	ON
State Saved:	Saved in instrument state.
Example:	:CALC:CDP:ASET ON :CALC:CDP:ASET?

### Code Domain—Measurement Channel Type

**:CALCulate:CDPower:CHANnel:TYPE DATA|MAC|PILot**

**:CALCulate:CDPower:CHANnel:TYPE?**

Set one of the channel types from the following channels:

DATA – the data channel

MAC – the medium access control (MAC) channel

PILot – the pilot channel

Factory Preset: PILOT

Remarks: You must be in the 1xEV-DO mode to use this command. Use INSTRument:SElect to set the mode.

### Code Domain—I/Q Combined Power

**:CALCulate:CDPower:IQ:COMBined[:STATE] OFF|ON|0|1**

**:CALCulate:CDPower:IQ:COMBined[:STATE]?**

Turn the I/Q Combined Power Bar on or off.

On- compute I/Q combined power bar.

Off- compute I/Q separated power bar.

Factory Preset: Off

Remarks: You must be in the 1xEV-DO mode to use this command. Use INSTRument:SElect to set the mode.

### Code Domain—Sweep Offset (Measurement Offset)

**:CALCulate:CDPower:SWEep:OFFSet <integer>**

**:CALCulate:CDPower:SWEep:OFFSet <float>** (1xEV-DO only)

**:CALCulate:CDPower:SWEep:OFFSet?**

1xEV-DO mode:

Set the timing offset of measurement interval in units of slot (1 slot = 1.667 ms).

The sum of **CALCulate:CDPower:SWEep:TIME** and **CALCulate:CDPower:SWEep:OFFSet** must be equal to or less than **SENSe:CDPower:CAPTure:TIME**. If the sum becomes more than the value, **CALCulate:CDPower:SWEep:OFFSet** is adjusted automatically.

cdma2000 mode:

Set the timing offset of measurement interval in units of Power Control Group (PCG; 1 PCG = 1.25 ms).

The sum of **CALCulate:CDPower:SWEep:TIME** and **CALCulate:CDPower:SWEep:OFFSet** must be equal to or less than **SENSe:CDPower:CAPTure:TIME**. If the sum becomes more than the value, **CALCulate:CDPower:SWEep:OFFSet** is adjusted automatically.

W-CDMA mode:

Set the timing offset of measurement interval in slots (1 slot = 625  $\mu$ s).

The sum of **CALCulate:CDPower:SWEep:TIME** and **CALCulate:CDPower:SWEep:OFFSet** must be equal to or less than **SENSe:CDPower:CAPTure:TIME**  $\times$  15. If the sum becomes more than the value, **CALCulate:CDPower:SWEep:OFFSet** is adjusted automatically.

Factory Preset: 0

Range: 0 to **SENSe:CDPower:CAPTure:TIME** - 1 for cdma2000

0 to **SENSe:CDPower:CAPTure:TIME** – 0.5 for 1xEV-DO  
0 to **SENSe:CDPower:CAPTure:TIME** × 15 – 1 for  
W-CDMA

Remarks: You must be in the cdma2000, W-CDMA, or 1xEV-DO mode to use this command. Use **INSTRument:SElect** to set the mode.

### Code Domain—Sweep Time (Measurement Interval)

**:CALCulate:CDPower:SWEep:TIME** <integer>

**:CALCulate:CDPower:SWEep:TIME** <float> for (1xEV-DO only)

**:CALCulate:CDPower:SWEep:TIME?**

- For 1xEV-DO

Set the length of measurement interval in units of slot (1 slot = 1.667 ms).

The sum of **CALCulate:CDPower:SWEep:TIME** and **CALCulate:CDPower:SWEep:OFFSet** must be equal to or less than **SENSe:CDPower:CAPTure:TIME**. If the sum becomes more than the value, **CALCulate:CDPower:SWEep:OFFSet** is adjusted automatically.

- For cdma2000

Set the length of measurement interval in the unit of Power Control Group (PCG; 1 PCG = 1.25 ms).

The sum of **CALCulate:CDPower:SWEep:TIME** and **CALCulate:CDPower:SWEep:OFFSet** must be equal to or less than **SENSe:CDPower:CAPTure:TIME**. If the sum becomes more than the value, **CALCulate:CDPower:SWEep:OFFSet** is adjusted automatically.

- For W-CDMA

Set the length of measurement interval in slots (1 slot = 625 μs).

The sum of **CALCulate:CDPower:SWEep:TIME** and **CALCulate:CDPower:SWEep:OFFSet** must be equal to or less than **SENSe:CDPower:CAPTure:TIME** × 15. If the sum becomes more than the value, **CALCulate:CDPower:SWEep:OFFSet** is adjusted automatically.

Factory Preset: 1

Range: 1 to **SENSe:CDPower:CAPTure:TIME** for cdma2000  
0.5 to **SENSe:CDPower:CAPTure:TIME** for 1xEV-DO  
1 to **SENSe:CDPower:CAPTure:TIME** × 15 for W-CDMA

Remarks: You must be in the cdma2000, W-CDMA, or 1xEV-DO mode to use this command. Use INSTRUMENT:SElect to set the mode.

### Code Domain—Computation Type

**:CALCulate:CDPower:TYPE ABSolute|RELative**

**:CALCulate:CDPower:TYPE?**

Set the code domain power computation type to either the absolute power or the relative value to the mean power.

ABSolute – code domain power is computed as the absolute power.

RELative – code domain power is computed relative to the mean power.

Factory Preset: RELative

Remarks: You must be in the cdma2000 , W-CDMA, or 1xEV\_DO mode to use this command. Use INSTRUMENT:SElect to set the mode.

### Code Domain—Data Channel Type

**:CALCulate:CDPower:TYPE:DATA OPSK|QAM|QPSK**

**:CALCulate:CDPower:TYPE:DATA?**

Select one of the following data channel types to be used for encoding:

OPSK - 8 phase shift keying (8PSK).

QAM - 16 quadrature phase shift keying (16QAM)

QPSK - Quadrature phase shift keying

Factory Preset: QPSK

Remarks: You must be in the 1xEV-DO mode to use this command. Use INSTRUMENT:SElect to set the mode.

### Code Domain—Walsh Code Number

**:CALCulate:CDPower:WCode[:NUMBER] <integer>**

**:CALCulate:CDPower:WCode[:NUMBER]?**

Set the Walsh code number depending on the channel type.

Factory Preset: 0

Range: 0 to CALCulate:CDPower:WCode:LENGth – 1, for



cdma2000

0 to 31 for Pilot,  
0 to 63 for MAC,  
0 to 15 for Data (1xEV-DO)

Remarks: You must be in the cdma2000 or 1xEV-DO mode to use this command. Use INSTRument:SElect to set the mode.

### Code Domain—Walsh Code Order

**:CALCulate:CDPower:WCODe:ORDer BREVerse | HADmrd**

**:CALCulate:CDPower:WCODe:ORDer?**

Set the type of the Walsh code order to either of the following:

BREVerse (Bit Reverse) – In the order to show the higher (consolidated) spreading code as a single bundle in the CDP display

HADmrd (Hadamard) – Regular order

Factory Preset: Hadamard (HADmrd)

Remarks: You must be in the cdma2000, or 1xEV-DO mode to use this command. Use INSTRument:SElect to set the mode.

## Occupied Bandwidth - Limits

### Occupied Bandwidth—Frequency Band Limit

PDC, cdma2000, W-CDMA, 1xEV-DO mode

**:CALCulate:OBW:LIMit:FBLimit <freq>**

**:CALCulate:OBW:LIMit:FBLimit?**

iDEN mode (E4406A only)

**:CALCulate:OBWidth:LIMit:FBLimit <freq>**

**:CALCulate:OBWidth:LIMit:FBLimit?**

Set the frequency bandwidth limit in Hz.

Factory Preset: 32 kHz for PDC

20 kHz for iDEN (E4406A only)

1.48 MHz for cdma2000, 1xEV-DO

5 MHz for W-CDMA

Range: 10 kHz to 60 kHz for PDC, iDEN (E4406A only)

10 kHz to 10 MHz for cdma2000, W-CDMA, 1xEV-DO

Default Unit: Hz

Remarks: You must be in the iDEN (E4406A only), PDC, cdma2000, W-CDMA, or 1xEV-DO mode to use this command. Use INSTRument:SElect to set the mode.

History: For E4406A:  
Version A.02.00 or later

### Occupied Bandwidth—Limit Test

PDC, cdma2000, W-CDMA, 1xEV-DO mode

**:CALCulate:OBW:LIMit[:TEST] OFF | ON | 0 | 1**

**:CALCulate:OBW:LIMit[:TEST]?**

iDEN mode (E4406A only)

**:CALCulate:OBWidth:LIMit:STATe OFF | ON | 0 | 1**

**:CALCulate:OBWidth:LIMit:STATe?**

Turn the limit test function on or off.

Factory Preset: ON

Remarks: You must be in the iDEN (E4406A only), PDC, cdma2000, W-CDMA, or 1xEV-DO mode to use this

command. Use INSTRument:SElect to set the mode.

History:

For E4406A:

Version A.02.00 or later

## Power Statistic CCDF—Store Reference

**:CALCulate:PStAtistic:StORe:REFEreNce ON|1**

Store the currently measured trace as the user-defined reference trace. No query command is available.

Remarks: You must be in the cdma2000, W-CDMA, or 1xEV-DO mode to use this command. Use INSTRument:SELEct to set the mode.

## Terminal Code Domain Power Measurement

---

**NOTE**

The Terminal Code Domain Power (TCDP) measurement is used for 1xEV-DO reverse link analysis. The 1xEV-DO standard defines MS as “Access Terminal” and BTS as “Access Network”. Therefore, even if **MS(Rev)** is selected under **Radio Device**, TCDP SCPI must be used for measurement remote control.

---

### Terminal Code Domain- Active Set Threshold Auto

**:CALCulate:TCDPower:ASET:THReshold <rel\_amp>**

**:CALCulate:TCDPower:ASET:THReshold?**

**:CALCulate:TCDPower:ASET:THReshold:AUTO OFF|ON|0|1**

**:CALCulate:TCDPower:ASET:THReshold:AUTO?**

Set the threshold value for the active channel detection. The user can set the active channel identification function to either Auto or Man. If set to Auto, the active channels are determined automatically by the internal algorithm. If set to Man, the active channel identification is determined by a user definable threshold ranging from 0.00 to –100.0 dB.

Key Path:	<b>Meas Setup, More 1 of 3, More 2of 3, Advanced</b>
Unit/Terminator	dB
Keys:	
Preset:	0.0 , ON
State Saved:	Saved in instrument state.
Range:	–100 to 0.0 , Auto   Man
Example:	:CALC:TCDP:ASET:THR –20 :CALC:TCDP:ASET:THR:AUTO OFF

Remote Command Notes: Turn the automatic mode On or Off, for the active channel identification function.

OFF – The active channel identification for each code channel is determined by a value set by :CALCulate:TCDPower:ASET:THRshold.

ON – The internal algorithm determines the active channels automatically.

### Terminal Code Domain- I/Q Branch

**:CALCulate:TCDPower:AXIS IPH|QPH|IQCombined**

**:CALCulate:TCDPower:AXIS?**

Allows you to toggle the selection of the branch signals between I, Q, and IQC (I/Q Combined) for demodulation axis.

When the user specifies “I” or “Q”, then both I/Q measured trace and reference points are projected on the I or Q axis, respectively.

When the user specifies “IQC”, the I/Q projection is skipped. Therefore, when the user measures a BPSK signal this parameter must be set to either “I” or “Q”. When the user measures QPSK or 8PSK signals, this parameter should be set to “IQC”.

This parameter is effective for symbol analysis, but is not effective for modulation type detection or code power calculation.

Key Path:	<b>Meas Setup</b>
Preset:	IPH
State Saved:	Saved in instrument state.
Range:	I   Q   IQC
Example:	:CALC:TCDP:AXIS QPH

### Terminal Code Domain- I/Q Combined Power Bar

**:CALCulate:TCDPower:IQ:COMBined[:STATe] ON|OFF|0|1**

**:CALCulate:TCDPower:IQ:COMBined[:STATe]?**

Allows you to toggle the I/Q combined power display function between On and Off. If set to On, the I and Q power bars are consolidated on the upper side of the horizontal axis. If set to Off, the I and Q power bars are shown on the upper side and the lower side of the horizontal axis, respectively.

When the I/Q Combined Power Bar key is set to On, a marker indicates I/Q combined power. Demodulation performed by pressing the **Mkr->Despread** key is done with I/Q combined. In that case, the SCPI

query result is I/Q combined data.

Key Path:           **Display**  
Preset:             OFF  
State Saved:        Saved in instrument state.  
Range:              On | Off  
Example:            :CALC:TCDP:IQ:COMB ON

### Terminal Code Domain- Marker to Trace

**:CALCulate:TCDPower:MARKer:TRACe**  
**CDPower | CDError | EVM | MERRor | PERRor | SPOWer | CPOWer**

**:CALCulate:TCDPower:MARKer:TRACe?**

Set the active marker.

Key Path:           **Marker**  
Preset:             CDPower  
State Saved:        Saved in instrument state.  
Range:              Code Domain Power | Code Domain Error |  
                      Symbol Power | Chip Power | EVM | Phase  
                      Error | Mag Error  
Example:            :CALC:TCDP:MARK:TRAC SPOW

### Terminal Code Domain- Packed Mode

**:CALCulate:TCDPower:PACKed OFF | PKM1**  
**:CALCulate:TCDPower:PACKed?**

Allows you to select the packed mode for Demod bits in SCPI result of READ:TCDP12.

This function makes the demod bits per symbol to pack into one floating value following the detected modulation format. User knows which format is detected on the selected channel using the return value of READ:TCDP14.

For example, if the detected modulation format is QPSK, the returning demod bits with non-packed mode (default) are following.

0.0, 1.0, 0.0, 1.0, 0.0, 1.0, 1.0, 1.0,.....

QPSK is 2 bits per symbols modulation. Therefore with packed mode, by 2 bits are packed into one floating value.

1.0, 1.0, 1.0, 3.0, .....

For 8PSK modulation, by 3 bits are packed into one floating value.

For BPSK modulations, as a result, the demod bits with packed mode and the one with non-packed mode are same because BPSK modulation is 1bit per symbol.

Packed mode is only for SCPI commands. Setting packed mode does not make any changes to the results displayed on the front Panel. It only controls the result format of the SCPI command READ(MEAS | FETCh | CONF):TCDP 12.

Preset: OFF  
 State Saved: Saved in instrument state.  
 Example: CALC:TCDP:PACK PKM1

### Terminal Code Domain- Frequency Compensation

**:CALCulate:TCDPower:SEVM:FCOMpen ON|OFF|0|1**  
**:CALCulate:TCDPower:SEVM:FCOMpen?**

Allows you to toggle the setting of the frequency compensation to calculate the symbol EVM.

Key Path: Meas Setup, More 1 of 3, More 2of 3, Advanced, Symbol EVM Compensation  
 Preset: On  
 State Saved: Saved in instrument state.  
 Range: On | Off  
 Example: :CALC:TCDP:SEVM:FCOM OFF

### Terminal Code Domain- Phase Compensation

**:CALCulate:TCDPower:SEVM:PCOMpen ON|OFF|0|1**  
**:CALCulate:TCDPower:SEVM:PCOMpen?**

Allows you to toggle the setting of the phase compensation to calculate the symbol EVM.

Key Path: Meas Setup, More 1 of 3, More 2of 3, Advanced, Symbol EVM Compensation  
 Preset: On  
 State Saved: Saved in instrument state.  
 Range: On | Off

Example: `:CALC:TCDP:SEVM:PCOM OFF`

### Terminal Code Domain- Meas Offset

**`:CALCulate:TCDPower:SWEep:OFFSet <integer>`**

**`:CALCulate:TCDPower:SWEep:OFFSet?`**

Set the timing offset of measurement interval in slots.

Step (Front Panel)	0.5
Key Path	<b>Meas Setup</b>
Notes	If summation of Meas Interval and Meas Offset exceeds 32 after changing Meas Interval (or Meas Offset), then Meas Offset (or Meas Interval) decreases automatically to make the summation 32.
Preset	0.0
State Saved	Saved in instrument state.
SCPI Resolution	0.5
Dependencies/Couplings	Max value is dependent [:SENSE]:TCDPwer:CAPTure:TIME and :CALCulate:TCDPower:SWEep:TIME
Example	<code>:CALC:TCDP:SWE:OFFS 10</code>

### Terminal Code Domain- Meas Interval

**`:CALCulate:TCDPower:SWEep:TIME <integer>`**

**`:CALCulate:TCDPower:SWEep:TIME?`**

Set the length of measurement interval in slots.

Step (Front Panel)	0.5
Key Path	<b>Meas Setup</b>
Notes	Set the length of the measurement interval that will be used. If summation of Meas Interval and Meas Offset exceeds 32 after changing Meas Interval (or Meas Offset), then Meas Offset (or Meas Interval) decreases automatically to make the summation 32.
Preset	1.0
State Saved	Saved in instrument state.



SCPI Resolution	0.5
Dependencies/Couplings	Max value is dependent on [:SENSE]:TCDPower:CAPTURE:TIME and CALCulate:TCDPower:SWEep:OFFSet.
Example	:CALC:TCDP:SWE:TIME 8.5

### Terminal Code Domain - Measurement Type

**:CALCulate:TCDPower:TYPE ABSolute|RELative**

**:CALCulate:TCDPower:TYPE?**

Set the code domain power computation type to either the absolute power or the relative value to the mean power.

ABSolute – code domain power is computed as the absolute power.

RELative – code domain power is computed relative to the mean power.

Factory Preset: RELative

Remarks: You must be in the 1xEV\_DO mode to use this command. Use INSTRument:SElect to set the mode.

### Terminal Code Domain - Walsh Code Number

**:CALCulate:TCDPower:WCOde[:NUMBER] <integer>**

**:CALCulate:TCDPower:WCOde[:NUMBER]?**

Set the Walsh code number. The upper range is automatically determined by the maximum value for Walsh Code Length. Therefore there is a difference between the numbers available to Subtype 0/1 and Subtype 2.

Key Path	Meas Setup
Notes	Range and Min/Max of this command depends on selected physical layer subtype. If need to do SCPI test in the case of Subtype2 by SCPI tree tool, add the test manually.
Preset	0
State Saved	Saved in instrument state.

Range	0 to 1, when :CALCulate:TCDPower:WCODe:LENGth = 2 and Subtype 2
	0 to 3, when :CALCulate:TCDPower:WCODe:LENGth = 4
	0 to 7, when :CALCulate:TCDPower:WCODe:LENGth = 8
	0 to 15, when :CALCulate:TCDPower:WCODe:LENGth = 16
	0 to 31, when :CALCulate:TCDPower:WCODe:LENGth = 32 and Subtype 2
SCPI Resolution	1
Dependencies/Couplings	Max is dependent on :CALCulate:TCDPower:WCODe:LENGth.
Example	:CALC:TCDP:WCOD 8

### Terminal Code Domain - Walsh Code Order

```
:CALCulate:TCDPower:WCODe:ORDER BREVerse | (HADamard | HADMrd)  

:CALCulate:TCDPower:WCODe:ORDER?
```

Set the type of the Walsh code order to either of the following:

- BREVerse (Bit Reverse) – In the order to show the higher (consolidated) spreading code as a single bundle in the CDP display
- HADamard or HADMrd (Hadamard) – Regular order

Factory Preset: Hadamard (HADamard)

Remarks: You must be in the 1xEV-DO mode to use this command. Use INSTRument:SElect to set the mode.

### Modulation Accuracy Measurement (Rho)

#### Modulation Accuracy (Rho)—Active Threshold

```
:CALCulate:RHO:ASET:THReshold <numeric>  

:CALCulate:RHO:ASET:THReshold?
```

Set the threshold level for the active channel identification function.

Factory Preset: 0.0 dBm

Range: -100.0 to 0.0 dB

Remarks: You must be in the 1xEV-DO mode to use this command. Use INSTRument:SElect to set the mode.

**Modulation Accuracy (Rho)—Active Set Threshold Mode**

**:CALCulate:RHO:ASET:THReshold:AUTO OFF | ON | 0 | 1**

**:CALCulate:RHO:ASET:THReshold:AUTO?**

Turn the automatic mode On or Off, for the active channel identification function.

OFF – The active channel identification for each code channel is determined by a value set by CALCulate:RHO:ASET:THReshold.

ON – The active channels are determined automatically by the internal algorithm.

Factory Preset: ON

Remarks: You must be in W-CDMA, cdma2000, or 1xEV-DO mode to use this command. Use INSTRument:SElect to set the mode.

**Modulation Accuracy (Rho)—Rho Result I/Q Offset**

**:CALCulate:RHO:IQOffset:INCLude OFF | ON | 0 | 1**

**:CALCulate:RHO:IQOffset:INCLude?**

Turn the automatic mode On or Off, for the I/Q origin offset function.

OFF – The measurement results for EVM and Rho do not take into account the I/Q origin offset.

ON – The measurement results for EVM and Rho take into account the I/Q origin offset.

Factory Preset: ON

Remarks: You must be in the 1xEV-DO mode to use this command. Use INSTRument:SElect to set the mode.

**Modulation Accuracy (Rho)—Min Data Active Power**

**:CALCulate:RHO:LIMit:DATA[:ACTive]:LOWer <float>**

**:CALCulate:RHO:LIMit:DATA[:ACTive]:LOWer?**

Specify the DATA Active Power minimum limit value in dB.

Factory Preset: -15.55 dB

Range: -100.0 to

**:CALCulate:RHO:LIMit:DATA[:ACTive][:UPPer]dB**

Remarks: You must be in the 1xEV-DO mode to use this command. Use INSTRument:SElect to set the mode.

### Modulation Accuracy (Rho)—Max Data Active Power

**:CALCulate:RHO:LIMit:DATA[:ACTive][:UPPer] <float>**

**:CALCulate:RHO:LIMit:DATA[:ACTive][:UPPer]?**

Specify the DATA Active Power maximum limit value in dB.

Factory Preset: -14.56 dB

Range: -100.0 to 0.0 dB

Remarks: You must be in the 1xEV-DO mode to use this command. Use INSTRument:SElect to set the mode.

### Modulation Accuracy (Rho)—Frequency Error Limit

**:CALCulate:RHO:LIMit:FREQuency <numeric>**

**:CALCulate:RHO:LIMit:FREQuency?**

Specify a limit value in ppm for the frequency error test.

Factory Preset: 0.05 ppm

Range: 0.0 to 1.0 ppm

Unit: ppm

Remarks: You must be in the 1xEV-DO mode to use this command. Use INSTRument:SElect to set the mode.

Front Panel

Access: **Meas Setup, More, Limits...**

### Modulation Accuracy (Rho)—Max MAC Inactive Power

**:CALCulate:RHO:LIMit:MAC:INACTive[:UPPer]<float>**

**:CALCulate:RHO:LIMit:MAC:INACTive[:UPPer]?**

Specify the MAC inactive power limit value in dB.

Factory Preset: -27.00 dB

Range: -100.0 to 0 dB

Unit: ppm

Remarks: You must be in the 1xEV-DO mode to use this

command. Use INSTRument:SElect to set the mode.

Front Panel

Access: **Meas Setup, More, Limits...**

### **Modulation Accuracy (Rho)—Peak EVM Limit (BTS)**

**:CALCulate:RHO:LIMit:PEAK[:BTS] <float>**

**:CALCulate:RHO:LIMit:PEAK[:BTS]?**

Specify a limit value in percent for the peak EVM test.

Factory Preset: 100.0%

Range: 0.0 to 200.0%

Remarks: You must be in the 1xEV-DO mode to use this command. Use INSTRument:SElect to set the mode.

### **Modulation Accuracy (Rho)—Phase Error Limit**

**:CALCulate:RHO:LIMit:PHASe <float>**

**:CALCulate:RHO:LIMit:PHASe?**

Specify a limit value in radian for the phase error test.

Factory Preset: 0.05 rad

Range: 0.00 to 3.00 rad

Remarks: You must be in the cdma2000 or 1xEV-DO mode to use this command. Use INSTRument:SElect to set the mode.

### **Modulation Accuracy (Rho)—Pilot Time Offset Limit**

**:CALCulate:RHO:LIMit:POFFset <float>**

**:CALCulate:RHO:LIMit:POFFset?**

Specify a limit value for the Pilot time offset test from the external trigger.

Factory Preset: 10.0  $\mu$ s

Range: 0.0 to 100.0  $\mu$ s

Remarks: You must be in the 1xEV-DO mode to use this command. Use INSTRument:SElect to set the mode.

### Modulation Accuracy (Rho)—Rho Limit (BTS)

**:CALCulate:RHO:LIMit:RHO[:BTS] <float>**

**:CALCulate:RHO:LIMit:RHO[:BTS]?**

Specify a limit value for the Rho test.

Factory Preset: 0.5

Range: 0 to 1.0

Remarks: You must be in the 1xEV-DO mode to use this command. Use INSTRument:SElect to set the mode.

### Modulation Accuracy (Rho)—RMS EVM Limit (BTS)

**:CALCulate:RHO:LIMit:RMS[:BTS] <float>**

**:CALCulate:RHO:LIMit:RMS[:BTS]?**

Specify a limit value in percent for the rms EVM test.

Factory Preset: 17.5%

Range: 0.0 to 100.0%

Remarks: You must be in the 1xEV-DO mode to use this command. Use INSTRument:SElect to set the mode.

### Modulation Accuracy (Rho)—Time Offset Limit

**:CALCulate:RHO:LIMit:TIMing <float>**

**:CALCulate:RHO:LIMit:TIMing?**

Specify a limit value in second for the time offset test.

Factory Preset: 0.00000005 s (50 ns)

Range: 0 to 0.00000005 s (0 to 500 ns)

Remarks: You must be in the cdma2000 or 1xEV-DO mode to use this command. Use INSTRument:SElect to set the mode.

### Modulation Accuracy (Rho)—Channel Type

**:CALCulate:RHO:TYPE ALL | DATA | MAC | PILOt | PREAmble**

**:CALCulate:RHO:TYPE?**

Select one of the following channel types to be used measurements.

ALL – measure Rho Overall-1 and Rho Overall-2 as specified in

3GPP2 TSG-4.1 Recommended Minimum Performance Standard for cdma2000 High Rate Data Packet Access Network, 11.4.2. Waveform Quality Measurement section.

DATA – measure the data channel.

MAC – measure the medium access control (MAC) channel.

PILOt – measure the Pilot channel.

PREAmble – measure the preamble data chips overlaid on the data channel.

Factory Preset: PILOt

Remarks: You must be in the 1xEV-DO mode to use this command. Use INSTRument:SElect to set the mode.

### **Modulation Accuracy (Rho)—Data Type**

**:CALCulate:RHO:TYPE:DATA OPSK | QAM | QPSK**

**:CALCulate:RHO:TYPE:DATA?**

Select one of the following data types to be used for encoding.

OPSK – Eight phase shift keying (8PSK)

QAM – Sixteen quadrature amplitude modulation (16QAM)

QPSK – Quadrature phase shift keying

Factory Preset: QPSK

Remarks: You must be in the 1xEV-DO mode to use this command. Use INSTRument:SElect to set the mode.

## Terminal Modulation Accuracy Measurement

---

**NOTE**

The Terminal Modulation Accuracy (TRHO) measurement is used for 1xEV-DO reverse link analysis. The 1xEV-DO standard defines MS as “Access Terminal” and BTS as “Access Network”. Therefore, even if **MS(Rev)** is selected under **Radio Device**, TRHO SCPI must be used for measurement remote control.

---

### Terminal Modulation Accuracy - I/Q Combined Power Bar

**:CALCulate:TRHO:IQ:COMBined[:STATE] ON|OFF|0|1**

**:CALCulate:TRHO:IQ:COMBined[:STATE]?**

Allows you to toggle the I/Q combined power display function between On and Off. If set to On, the I and Q power bars are consolidated on the upper side of the horizontal axis. If set to Off, the I and Q power bars are shown on the upper side and the lower side of the horizontal axis, respectively.

When I/Q Combined Power Bar key is set to On, a Marker indicates I/Q combined power.

Key Path:	<b>Display</b>
Preset:	OFF
State Saved:	Saved in instrument state.
Range:	On   Off
Example:	<b>:CALC:TRHO:IQ:COMB ON</b>



## Terminal Modulation Accuracy - Limits

### Terminal Modulation Accuracy (Rho)—Active Set Threshold

**:CALCulate:TRHO:ASET:THReshold <numeric>**

**:CALCulate:TRHO:ASET:THReshold?**

Set the threshold level for the active channel identification function.

Factory Preset: 0.0 dB

Range: -100.0 to 0.0 dB

Remarks: You must be in the 1xEV-DO mode to use this command. Use INSTRument:SElect to set the mode.

### Terminal Modulation Accuracy (Rho)—Active Set Threshold Mode

**:CALCulate:TRHO:ASET:THReshold:AUTO OFF|ON|0|1**

**:CALCulate:TRHO:ASET:THReshold:AUTO?**

Turn the automatic mode On or Off, for the active channel identification function.

OFF – The active channel identification for each code channel is determined by a value set by CALCulate:RHO:ASET:THReshold.

ON – The active channels are determined automatically by the internal algorithm.

Factory Preset: ON

Remarks: You must be in 1xEV-DO mode to use this command. Use INSTRument:SElect to set the mode.

### Terminal Modulation Accuracy (Rho)—I/Q Offset Include

**:CALCulate:TRHO:IQOFFset:INCLude OFF|ON|0|1**

**:CALCulate:TRHO:IQOFFset:INCLude?**

Turn the automatic mode On or Off, for the I/Q origin offset function.

OFF – The measurement results for EVM and Rho do not include the I/Q origin offset.

ON – The measurement results for EVM and Rho include the I/Q origin offset.

Factory Preset: ON

Remarks: You must be in the 1xEV-DO mode to use this command. Use INSTRument:SElect to set the mode.

### Terminal Modulation Accuracy (Rho)—Active Code Domain Power Tolerance

**:CALCulate:TRHO:LIMit:ACDPower <float>**

**:CALCulate:TRHO:LIMit:ACDPower?**

Set the Active Code Domain Power tolerance limit in dB.

Factory Preset: 0.25 dB

Range: 0.0 to 3.0 dB

Remarks: You must be in the 1xEV-DO mode to use this command. Use INSTRument:SElect to set the mode.

### Terminal Modulation Accuracy (Rho)—ACK Channel Power Gain

**:CALCulate:TRHO:LIMit:ACK:GAIN <float>**

**:CALCulate:TRHO:LIMit:ACK:GAIN?**

Set the ACK channel power gain in dB.

Factory Preset: 3.0 dB

Range: -10.0 to 10.0 dB

Remarks: You must be in the 1xEV-DO mode to use this command. Use INSTRument:SElect to set the mode.

### Terminal Modulation Accuracy (Rho)—Peak Code Domain Error Limit

**:CALCulate:TRHO:LIMit:CDERror <float>**

**:CALCulate:TRHO:LIMit:CDERror?**

Set the Peak Code Domain Error limit in dB.

Factory Preset: -40.0 dB

Range: -100.0 to 0.0 dB

Remarks: You must be in the 1xEV-DO mode to use this command. Use INSTRument:SElect to set the mode.

### Terminal Modulation Accuracy (Rho)—Data Channel Power Gain

**:CALCulate:TRHO:LIMit:DATA:GAIN <float>**

**:CALCulate:TRHO:LIMit:DATA:GAIN?**

Set the Data channel power gain in dB.

Factory Preset: 3.75 dB

Range: -10.0 to 10.0 dB

Remarks: You must be in the 1xEV-DO mode to use this command. Use INSTRument:SElect to set the mode.

### Terminal Modulation Accuracy (Rho)—DRC Channel Power Gain

**:CALCulate:TRHO:LIMit:DRC:GAIN <float>**

**:CALCulate:TRHO:LIMit:DRC:GAIN?**

Set the DRC channel power gain in dB.

Factory Preset: 3.0 dB

Range: -10.0 to 10.0 dB

Remarks: You must be in the 1xEV-DO mode to use this command. Use INSTRument:SElect to set the mode.

### Terminal Modulation Accuracy (Rho)—Frequency Error Limit

**:CALCulate:TRHO:LIMit:FERRor <float>**

**:CALCulate:TRHO:LIMit:FERRor?**

Set the Frequency Error limit in Hz.

Factory Preset: 300.0 Hz

Range: 0.0 to 10.0 kHz

Remarks: You must be in the 1xEV-DO mode to use this command. Use INSTRument:SElect to set the mode.

### Terminal Modulation Accuracy (Rho)—Inactive Channel CDP

**:CALCulate:TRHO:LIMit:ICDPower <float>**

**:CALCulate:TRHO:LIMit:ICDPower?**

Specify the Max inactive code domain power limit value in dBc.

Factory Preset: -23.00 dBc  
Range: -100.0 to 0 dBc  
Remarks: You must be in the 1xEV-DO mode to use this command. Use INSTRument:SElect to set the mode.

Front Panel  
Access: Meas Setup, More, Limits...

### Inactive Channel CDP with Subtype 0/1

**:CALCulate:TRHO:LIMit:ICDPower[:SUB0] <real>**

**:CALCulate:TRHO:LIMit:ICDPower[:SUB0]?**

Allows you to set the limit for inactive channel code domain power measurement result with Subtype 0 or 1.

Key Path: Meas Setup, Limits, More 1 of 3

Unit/Terminator Keys: dBc

Preset: -23

State Saved: Saved in instrument state.

Range: -100 to 0

SCPI Resolution: 0.1

Step (Front Panel): 0.1

Example: :CALC:TRHO:LIM:ICDP -30

### Inactive Channel CDP with Subtype 2

**:CALCulate:TRHO:LIMit:ICDPower:SUB2 <real>**

**:CALCulate:TRHO:LIMit:ICDPower:SUB2?**

Allows you to set the limit for inactive channel code domain power measurement result with Subtype 2.

Key Path: Meas Setup, Limits, More 1 of 3

Unit/Terminator Keys: dBc

Preset: -23

State Saved: Saved in instrument state.

Range: -100 to 0

SCPI Resolution: 0.1  
 Step (Front Panel): 0.1  
 Example: :CALC:TRHO:LIM:ICDP:SUB2 -30

### Terminal Modulation Accuracy (Rho)—Peak EVM Limit

**:CALCulate:TRHO:LIMit:PEAK <float>**  
**:CALCulate:TRHO:LIMit:PEAK?**

Specify a limit value in percent for the peak EVM test.

Factory Preset: 100.0%  
 Range: 0.0 to 200.0%  
 Resolution: 0.1%  
 Step: 0.1%  
 Remarks: You must be in the 1xEV-DO mode to use this command. Use INSTRument:SElect to set the mode.

### Terminal Modulation Accuracy (Rho)—Pilot Time Offset Limit

**:CALCulate:TRHO:LIMit:POFFset <float>**  
**:CALCulate:TRHO:LIMit:POFFset?**

Specify a limit value for the Pilot time offset test from the external trigger.

Factory Preset: 1.0  $\mu$ s  
 Range: 0.0 to 100.0 ms  
 Remarks: You must be in the 1xEV-DO mode to use this command. Use INSTRument:SElect to set the mode.

### Terminal Modulation Accuracy (Rho)—Rho Limit

**:CALCulate:TRHO:LIMit:RHO <float>**  
**:CALCulate:TRHO:LIMit:RHO?**

Specify a limit value for the Rho test.

Factory Preset: 0.5  
 Range: 0 to 1.0  
 Remarks: You must be in the 1xEV-DO mode to use this command. Use INSTRument:SElect to set the mode.

### Terminal Modulation Accuracy (Rho)—RMS EVM Limit

**:CALCulate:TRHO:LIMit:RMS <float>**

**:CALCulate:TRHO:LIMit:RMS?**

Specify a limit value in percent for the rms EVM test.

Factory Preset: 50.0%

Range: 0.0 to 100.0%

Remarks: You must be in the 1xEV-DO mode to use this command. Use INSTRument:SElect to set the mode.

### Terminal Modulation Accuracy (Rho)—RMS Limits

**:CALCulate:TRHO:LIMit:RMS[:SUB0] <real>**

**:CALCulate:TRHO:LIMit:RMS[:SUB0]?**

Allows you to set the limit for composite RMS EVM measurement result with Subtype 0.

Active Function Text:	RMS EVM
Key Path:	<b>Meas Setup, Limits</b>
Unit/Terminator Keys:	PCT
Front Panel Unit/Terminator Keys:	%
Preset:	50
State Saved:	Saved in instrument state.
Range:	0 to 100
Step (Front Panel):	0.1
Example:	:CALC:TRHO:LIM:RMS 25

### Terminal Modulation Accuracy (Rho)—RRI Relative Power Limit

**:CALCulate:TRHO:LIMit:RRI <float>**

**:CALCulate:TRHO:LIMit:RRI?**

Specify a tolerance limit for the RRI Power (ratio to Pilot) value in dB.

Factory Preset: 0.25 dB

Range: 0.00 to 3.00

Remarks: You must be in the 1xEV-DO mode to use this

command. Use INSTRument:SElect to set the mode.

### Peak EVM (Composite) with Subtype 0/1

**:CALCulate:TRHO:LIMit:PEAK[:SUB0] <real>**

**:CALCulate:TRHO:LIMit:PEAK[:SUB0]?**

Allows you to set the limit for composite peak EVM measurement result with Subtype 0 or 1

Active Function Text:	Peak EVM
Key Path:	<b>Meas Setup, Limits</b>
Unit/Terminator Keys:	PCT
Front Panel Unit/Terminator Keys:	%
Preset:	100
State Saved:	Saved in instrument state.
Range:	0 to 200
Step (Front Panel):	0.1
Example:	:CALC:TRHO:LIM:PEAK 125

### Peak EVM (Composite) with Subtype 2

**:CALCulate:TRHO:LIMit:PEAK;SUB2 <real>**

**:CALCulate:TRHO:LIMit:PEAK:SUB2?**

Allows you to set the limit for composite peak EVM measurement result with Subtype 2.

Key Path:	<b>Meas Setup, Limits</b>
Unit/Terminator Keys:	PCT
Front Panel Unit/Terminator Keys:	%
Preset:	100
State Saved:	Saved in instrument state.
Range:	0 to 200
Step (Front Panel):	0.1
Example:	:CALC:TRHO:LIM:PEAK:SUB2 125

### Rho (Composite) with Subtype 0/1

**:CALCulate:TRHO:LIMit:RHO[:SUB0] <real>**

**:CALCulate:TRHO:LIMit:RHO[:SUB0]?**

Allows you to set the limit for composite Rho measurement result with Subtype 0 or 1.

Key Path:	<b>Meas Setup, Limits</b>
Preset:	0.94400
State Saved:	Saved in instrument state.
Range:	0 to 1
Step (Front Panel):	0.00001
Example:	:CALC:TRHO:LIM:RHO 0.955

### Rho (Composite) with Subtype 2

**:CALCulate:TRHO:LIMit:RHO:SUB2 <real>**

**:CALCulate:TRHO:LIMit:RHO:SUB2?**

Allows you to set the limit for composite Rho measurement result with Subtype 2.

Key Path:	<b>Meas Setup, Limits</b>
Preset:	0.94400
State Saved:	Saved in instrument state.
Range:	0 to 1
Step (Front Panel):	0.00001
Example:	:CALC:TRHO:LIM:RHO:SUB1 0.955

### Peak Code Domain Error with Subtype 0/1

**:CALCulate:TRHO:LIMit:CDERror[:SUB0] <real>**

**:CALCulate:TRHO:LIMit:CDERror[:SUB0]?**

Set the Peak Code Domain Error limit in dB with Subtype 0 or 1.

Key Path:	<b>Meas Setup, Limits</b>
Unit/Terminator Keys:	dB
Preset:	0.0
State Saved:	Saved in instrument state.



Range: -100 to 0  
 SCPI Resolution: 0.1  
 Step (Front Panel): 0.1  
 Example: :CALC:TRHO:LIM:CDER -20

### Peak Code Domain Error with Subtype 2

**:CALCulate:TRHO:LIMit:CDERror:SUB2 <real>**

**:CALCulate:TRHO:LIMit:CDERror:SUB2?**

Set the Peak Code Domain Error limit in dB with Subtype 2.

Key Path: **Meas Setup, Limits**  
 Unit/Terminator Keys: dB  
 Preset: 0.0  
 State Saved: Saved in instrument state.  
 Range: -100 to 0  
 SCPI Resolution: 0.1  
 Step (Front Panel): 0.1  
 Example: :CALC:TRHO:LIM:CDER:SUB2 -20

### Frequency Error with Subtype 0/1

**:CALCulate:TRHO:LIMit:FERRor[:SUB0] <real>**

**:CALCulate:TRHO:LIMit:FERRor[:SUB0]?**

Set the Frequency Error limit with Subtype 0 or 1.

Key Path: **Meas Setup, Limits**  
 Unit/Terminator Keys: Hz | kHz | MHz | GHz  
 Front Panel Unit/Terminator Keys: Hz | kHz  
 Preset: 300 Hz  
 State Saved: Saved in instrument state.  
 Range: 0 Hz to 10kHz  
 SCPI Resolution: 0.001  
 Step (Front Panel): 0.001

Example: :CALC:TRHO:LIM:FERR 500

### Frequency Error with Subtype 2

**:CALCulate:TRHO:LIMit:FERRor:SUB2 <real>**

**:CALCulate:TRHO:LIMit:FERRor:SUB2?**

Set the Frequency Error limit with Subtype 2.

Key Path:	<b>Meas Setup, Limits</b>
Unit/Terminator Keys:	Hz   kHz   MHz   GHz
Front Panel	Hz   kHz
Unit/Terminator Keys:	
Preset:	300 Hz
State Saved:	Saved in instrument state.
Range:	0 Hz to 10kHz
SCPI Resolution:	0.001
Step (Front Panel):	0.001
Example:	:CALC:TRHO:LIM:FERR:SUB2 500 Hz

### Pilot Offset with Subtype 0/1

**:CALCulate:TRHO:LIMit:POFFset[:SUB0] <real>**

**:CALCulate:TRHO:LIMit:POFFset[:SUB0]?**

Allows you to set the limit for pilot offset time from the trigger timing with Subtype 0 or 1.

Key Path:	<b>Meas Setup, Limits</b>
Unit/Terminator Keys:	ks   s   ms   us   ns
Front Panel	ms   us   ns
Unit/Terminator Keys:	
Preset:	1 us
State Saved:	Saved in instrument state.
Range:	0 to 100.0 ms
SCPI Resolution:	0.01 us
Step (Front Panel):	0.01 us
Example:	:CALC:TRHO:LIM:POFF 650

## Pilot Offset with Subtype 2

**:CALCulate:TRHO:LIMit:POFFset:SUB2 <real>**

**:CALCulate:TRHO:LIMit:POFFset:SUB2?**

Allows you to set the limit for pilot offset time from the trigger timing with Subtype 2.

Key Path:	<b>Meas Setup, Limits</b>
Unit/Terminator Keys:	ks   s   ms   us   ns
Front Panel Unit/Terminator Keys:	ms   us   ns
Preset:	1 us
State Saved:	Saved in instrument state.
Range:	0 to 100.0 ms
SCPI Resolution:	0.01 us
Step (Front Panel):	0.01 us
Example:	:CALC:TRHO:LIM:POFF:SUB2 650ns

## RMS EVM (Composite) with Subtype 0/1

**:CALCulate:TRHO:LIMit:RMS:SUB0 <real>**

**:CALCulate:TRHO:LIMit:RMS:SUB0?**

Allows you to set the limit for composite RMS EVM measurement result with Subtype 0 or 1. This command maps to the SCPI command :CALCulate:TRHO:LIMit:RMS[:SUB0]. Its behaviour and default value is same.

Key Path:	<b>Meas Setup, Limits</b>
Unit/Terminator Keys:	PCT
Front Panel Unit/Terminator Keys:	%
Preset:	50
State Saved:	Saved in instrument state.
Range:	0 to 100
Step (Front Panel):	0.1
Example:	:CALC:TRHO:LIM:RMS:SUB0 25

## RMS EVM (Composite) with Subtype 2

**:CALCulate:TRHO:LIMit:RMS:SUB2 <real>**

**:CALCulate:TRHO:LIMit:RMS:SUB2?**

Allows you to set the limit for composite RMS EVM measurement result with Subtype 2.

Key Path:	Meas Setup, Limits
Unit/Terminator Keys:	PCT
Front Panel Unit/Terminator Keys:	%
Preset:	50
State Saved:	Saved in instrument state.
Range:	0 to 100
Step (Front Panel):	0.1
Example:	:CALC:TRHO:LIM:RMS:SUB2 25

**RRI Relative Power with Subtype 0/1**

**:CALCulate:TRHO:LIMit:RRI[:SUB0] <real>**

**:CALCulate:TRHO:LIMit:RRI[:SUB0]?**

Allows you to set the tolerance for RRI (reverse rate indicator) and pilot power ratio measurement result for Subtype 0 or 1.

Key Path:	Meas Setup, Limits, More 1 of 3, More 2 of 3
Unit/Terminator Keys:	dB
Preset:	0.25 dB
State Saved:	Saved in instrument state.
Range:	0 dB to 3.00 dB
SCPI Resolution:	0.01 dB
Step (Front Panel):	0.01 dB
Example:	:CALC:TRHO:LIM:RRI 0.35

**Active Code Domain Power Tolerance with Subtype 0/1**

**:CALCulate:TRHO:LIMit:ACDPower[:SUB0] <real>**

**:CALCulate:TRHO:LIMit:ACDPower[:SUB0]?**

Allows you to set the tolerance for each active code domain power level with its channel gain defined by DRC Chan Gain, ACK Chan Gain, or Data Chan Gain, respectively for Subtype 0 or 1. The range is 0.00 to

3.00 dB.

Key Path:	<b>Meas Setup, Limits, More 1 of 3, More 2 of 3</b>
Unit/Terminator Keys:	dB
Preset:	0.25 dB
State Saved:	Saved in instrument state.
Range:	0 dB to 3.00 dB
SCPI Resolution:	0.01 dB
Step (Front Panel):	0.01 dB
Example:	:CALC:TRHO:LIM:ACDP 0.35

### **DRC Channel Power Gain with Subtype 0/1**

**:CALCulate:TRHO:LIMit:DRC:GAIN[:SUB0] <real>**

**:CALCulate:TRHO:LIMit:DRC:GAIN[:SUB0]?**

Allows you to set the power gain level of the DRC (data rate control) channel relative to the pilot channel power level for Subtype 0 or 1.

Key Path:	<b>Meas Setup, Limits, More 1 of 3, More 2 of 3</b>
Unit/Terminator Keys:	dB
Preset:	3 dB
State Saved:	Saved in instrument state.
Range:	-10 dB to 10 dB
SCPI Resolution:	0.01 dB
Step (Front Panel):	0.01 dB
Example:	:CALC:TRHO:LIM:DRC:GAIN 4.2

### **ACK Channel Power Gain with Subtype 0/1**

**:CALCulate:TRHO:LIMit:ACK:GAIN[:SUB0] <real>**

**:CALCulate:TRHO:LIMit:ACK:GAIN[:SUB0]?**

Allows you to set the power gain level of the ACK (acknowledge) channel relative to the pilot channel power level for Subtype 0 or 1. The range is -10.00 to 10.00 dB.

Key Path:	<b>Meas Setup, Limits, More 1 of 3, More 2 of 3</b>
-----------	---

Unit/Terminator Keys: dB  
Preset: 3 dB  
State Saved: Saved in instrument state.  
Range: -10 dB to 10 dB  
SCPI Resolution: 0.01 dB  
Step (Front Panel): 0.01 dB  
Example: :CALC:TRHO:LIM:ACK:GAIN 4.2

### DATA Channel Power Gain with Subtype 0/1

**:CALCulate:TRHO:LIMit:DATA:GAIN[:SUB0] <real>**  
**:CALCulate:TRHO:LIMit:DATA:GAIN[:SUB0]?**

Allows you to set the power gain level of the data channel relative to the pilot channel power level for Subtype 0 or 1. The range is -10.00 to 10.00 dB.

Key Path: **Meas Setup, Limits, More 1 of 3, More 2 of 3**  
Unit/Terminator Keys: dB  
Preset: 3 dB  
State Saved: Saved in instrument state.  
Range: -10 dB to 10 dB  
SCPI Resolution: 0.01 dB  
Step (Front Panel): 0.01 dB  
Example: :CALC:TRHO:LIM:DATA:GAIN 4.2

### Terminal Modulation Accuracy - Marker

**:CALCulate:TRHO:MARKer:TRACe EVM|MERRor|PERRor|CDPower**  
**:CALCulate:TRHO:MARKer:TRACe?**

Set the active marker.

Key Path: **Marker**  
Preset: EVM  
State Saved: Saved in instrument state.  
Range: EVM | Phase Error | Mag Error | Code Domain Power  
Example: :CALC:TRHO:MARK:TRAC EVM

### Terminal Modulation Accuracy - Meas Offset

**:CALCulate:TRHO:SWEep:OFFSet <integer>**

**:CALCulate:TRHO:SWEep:OFFSet?**

Allows you to set the number of offset slots to make a symbol power measurement.

Key Path:	<b>Meas Setup</b>
Preset:	0.0
State Saved:	Saved in instrument state.
Range:	0.0 to 0.5
SCPI Resolution:	0.5
Step (Front Panel):	0.5
Example:	:CALC:TRHO:SWE:OFFS 0.5

### Terminal Modulation Accuracy - Code Order

**:CALCulate:TRHO:WCODe:ORDer BREVerse|HADMrd**

**:CALCulate:TRHO:WCODe:ORDer?**

Set the Walsh code order to Hadamard or Bit Reverse.

Key Path:	<b>Display</b>
Preset:	HADMrd
State Saved:	Saved in instrument state.
Range:	Hadmard   Bit Reverse
Example:	:CALC:TRHO:WCOD:ORD BREV

---

## CONFigure Subsystem

The CONFigure commands are used with several other commands to control the measurement process. The full set of commands are described in the section “MEASure Group of Commands” on page 375.

Selecting measurements with the CONFigure/FETCh/MEASure/READ commands sets the instrument state to the defaults for that measurement and to make a single measurement. Other commands are available for each measurement to allow you to change: settings, view, limits, etc. Refer to:

```
SENSE:<measurement>, SENSE:CHANnel, SENSE:CORRection,  
SENSE:DEFaults, SENSE:DEViation, SENSE:FREQuency,  
SENSE:PACKet, SENSE:POWer, SENSE:RADio, SENSE:SYNC  
CALCulate:<measurement>, CALCulate:CLIMits  
DISPlay:<measurement>  
TRIGger
```

The INITiate[:IMMediate] or INITiate:REStart commands will initiate the taking of measurement data without resetting any of the measurement settings that you have changed from their defaults.

### Configure the Selected Measurement

```
:CONFigure:<measurement>
```

A CONFigure command must specify the desired measurement. It will set the instrument settings for that measurement’s standard defaults, but should not initiate the taking of data. The available measurements are described in the MEASure subsystem.

---

**NOTE**

If CONFigure initiates the taking of data, the data should be ignored. Other SCPI commands can be processed immediately after sending CONFigure. You do not need to wait for the CONF command to complete this 'false' data acquisition.

---

### Configure Query

```
:CONFigure?
```

The CONFigure query returns the name of the current measurement.



## DISPlay Subsystem

The DISPlay controls the selection and presentation of textual, graphical, and TRACe information. Within a DISPlay, information may be separated into individual WINDows.

### Code Domain - View Selection

**:DISPlay:CDPower:VIEW PGRaph|IQPGraph**

**:DISPlay:CDPower:VIEW?**

Select one of the code domain measurement result views as follows:

PGRaph (Power Graph & Metrics) - provides a combination view of the code domain power graph and the summary data.

IQPGraph (I/Q Polar & Power Graph) - provides a combination view of the code doamin power graph, symbol I/Q polar graph, and chip power vs. time graph.

Factory Preset: PGRaph (Power Graph & Metrics)

Remarks: You must be in the 1xEV-DO mode to use this command. Use INSTRument:SElect to set the mode.

Front Panel

Access: **Code Domain, View/Trace**

### Select Display Format

**:DISPlay:FORMat:TILE**

Selects the viewing format that displays multiple windows of the current measurement data simultaneously. Use DISP:FORM:ZOOM to return the display to a single window.

Remarks: For PSA you must be in the Basic, cdmaOne,cdma2000, 1xEV-DO, W-CDMA, GSM (w/EDGE), NADC, or PDC mode to use this command. Use INSTRument:SElect to set the mode

Front Panel

Access: **Zoom** (toggles between Tile and Zoom)

## Select Display Format

**:DISPlay:FORMat:ZOOM**

Selects the viewing format that displays only one window of the current measurement data (the current active window). Use DISP:FORM:TILE to return the display to multiple windows.

Remarks: For PSA you must be in the Basic, cdmaOne,cdma2000, 1xEV-DO, W-CDMA, GSM (w/EDGE), NADC, or PDC mode to use this command. Use INSTRument:SElect to set the mode

Front Panel

Access: **Zoom** (toggles between Tile and Zoom)

## PVT - Limit Mask Display

**:DISPlay:PVTtime:LIMit:MASK OFF|ON|0|1**

**:DISPlay:PVTtime:LIMit:MASK?**

Turns on/off the display function of the limit mask lines. It also controls the limit checking function.

See also [:SENS]:PVT:LIM:MASK.

Factory Preset: ON

Remarks: You must be in GSM, EDGE, 1xEV-DO or W-CDMA mode to use this command. Use INSTRument:SElect to set the mode.

Front Panel

Access: **Power vs Time, Display**

## PVT - Burst Search Threshold Line

**:DISPlay:PVTtime:BURSt:STHreshold OFF|ON|0|1**

**:DISPlay:PVTtime:BURSt:STHreshold?**

Turn on or off the display function of the burst search threshold line.

ON - display the burst search threshold line.

OFF - disable to display the burst search threshold line.

Factory Preset: ON

Remarks: You must be in the 1xEV-DO mode to use this command. Use INSTRument:SElect to set the mode.

Front Panel  
 Access: **Power vs Time, Display**

## **PVT - View Selection**

**:DISPlay:PVTime:VIEW ALL|BOTH|A|B|C|D|E**

**:DISPlay:PVTime:VIEW?**

Select one of the power versus time measurement result views as follows:

ALL - displays the whole burst waveform throughout the all regions.

BOTH - displays both the rising and falling edges expanded in the horizontal scale.

A - display only the A region in the full horizontal scale.

B - display only the B region in the full horizontal scale.

C - display only the C region in the full horizontal scale.

D - display only the D region in the full horizontal scale.

E - display only the E region in the full horizontal scale.

Factory Preset: ALL

Remarks: You must be in the 1xEV-DO or W-CDMA mode to use this command. Use INSTRument:SElect to set the mode.

Front Panel  
 Access: **Power vs Time, View/Trace**

## **Modulation Accuracy (Rho) - View Selection**

1xEV-DO (Forward link)

**:DISPlay:RHO:VIEW Error|POLar|QUAD|TABLE|TPHase**

1xEV-DO (Reverse link)

**:DISPlay:RHO:VIEW Error|POLar|TABLE**

CDMA2000

**:DISPlay:RHO:VIEW Error|POLar**

W-CDMA

**:DISPlay:RHO:VIEW Error|POLar|PGRaph|TABLE**

**:DISPlay:RHO:VIEW?**

Select one of the modulation accuracy (rho) measurement result views as follows:

**ERRor (IQ Error: Quad View)** - provides a combination view of the EVM vs. symbol, phase error vs. symbol, magnitude error vs. symbol graphs, and the summary data for each channel type specified.

**POLar (IQ Measured Polar Graph)** - provides a combination view of the I/Q measured polar constellation graph and the summary data for each channel type specified.

**QUAD (IQ Measured: Quad-view)** - provides a combination view of an I/Q power vs. chip, I/Q vector absolute power vs. chip, I/Q polar graphs, and the summary data for each channel type specified.

**PGRaph (Code Domain Power)** - provides a combination view of Code Domain Power Graph, I/Q measured polar constellation and Active Channel Table.

**TABLE (Result Metrics)** - provides a measurement result on Rho, EVM, and other metrics of each channel type specified in tabular form.

**TPHase (Power Timing and Phase)** - provides a measurement result on power levels, timing, phase, and code domain errors in tabular form for each active code.

Factory Preset: POLar

Remarks: You must be in the 1xEV-DO, W-CDMA, or cdma2000 mode to use this command. Use INSTRUMENT:SElect to set the mode.

Front Panel

Access: **Mod Accuracy, View/Trace**

## Spectrum - Y-Axis Scale/Div

```
:DISPlay:SPECTrum[n]:WINDow[m]:TRACe:Y[:SCALE]:PDIVision  
<power>
```

```
:DISPlay:SPECTrum[n]:WINDow[m]:TRACe:Y[:SCALE]:PDIVision?
```

Sets the amplitude reference level for the y-axis.

n – selects the view, the default is Spectrum.

m – selects the window within the view. The default is 1.

— n=1, m=1 Spectrum

— n=1, m=2 I/Q Waveform

— n=1, m=2 I and Q Waveform (Basic, W-CDMA, cdma2000)

- n=1, m=3 numeric data (Service mode, E4406A only)
- n=1, m=4 RF envelope (Service mode, E4406A only)
- n=2, m=1 I Waveform (Option B7C, E4406A only)
- n=2, m=2 Q Waveform (Option B7C, E4406A only)
- n=3, m=1 I/Q Polar (Basic, W-CDMA, cdma2000)
- n=4, m=1 Linear Spectrum (Basic, W-CDMA, cdma2000)

Factory Preset: 10 dB per division, for Spectrum

100 mV per division, for I/Q Waveform

Range: 0.1 dB to 20 dB per division, for Spectrum

1 nV to 20 V per division, for I/Q Waveform

Default Unit: 10 dB per division, for Spectrum

Remarks: May affect input attenuator setting.

For E4406A to use this command, the appropriate mode should be selected with INSTRUMENT:SElect.

For PSA you must be in Basic, cdmaOne, cdma2000, 1xEV-DO, W-CDMA GSM w/EDGE, NADC, or PDC mode. Set the mode with INSTRUMENT:SElect.

Front Panel

Access: When in Spectrum measurement: **Amplitude Y Scale, Scale/Div.**

History: For PSA:  
 Added revision A.02.00

For E4406A:  
 Modified revision A.05.00

## Spectrum - Y-Axis Reference Level

**:DISPlay:SPECTrum[n]:WINDow[m]:TRACe:Y[:SCALE]:RLEvel**  
**<power>**

**:DISPlay:SPECTrum[n]:WINDow[m]:TRACe:Y[:SCALE]:RLEvel?**

Sets the amplitude reference level for the y-axis.

n, selects the view, the default is RF envelope.

- n=1, m=1 Spectrum
- n=1, m=2 I/Q Waveform
- n=1, m=2 I and Q Waveform (Basic, W-CDMA, cdma2000)

- n=1, m=3 numeric data (Service mode, E4406A only)
  - n=1, m=4 RF envelope (Service mode, E4406A only)
  - n=2, m=1 I Waveform (Option B7C, E4406A only)
  - n=2, m=2 Q Waveform (Option B7C, E4406A only)
  - n=3, m=1 I/Q Polar (Basic, W-CDMA, cdma2000)
  - n=4, m=1 Linear Spectrum (Basic, W-CDMA, cdma2000)
- m – selects the window within the view. The default is 1.

Factory Preset: 0 dBm, for Spectrum

Range: –250 to 250 dBm, for Spectrum

Default Unit: dBm, for Spectrum

Remarks: May affect input attenuator setting.

For E4406A to use this command, the appropriate mode should be selected with INSTRUMENT:SElect.

For PSA you must be in Basic, cdmaOne, cdma2000, 1xEV-DO, W-CDMA GSM w/EDGE, NADC, or PDC mode. Set the mode with INSTRUMENT:SElect.

Front Panel

Access: When in Spectrum measurement: **Amplitude Y Scale, Ref Level**

History: For PSA:  
Added revision A.02.00

For E4406A:  
Modified revision A.05.00

## Terminal Code Domain Measurement - View Selection

**:DISPlay:TCDPower:VIEW PGRaph | SEVM | QUAD | DBITs | CDPError**

**:DISPlay:TCDPower:VIEW?**

Key Path:	<b>View/Trace</b>
Preset:	PGRaph
State Saved:	Saved in instrument state.
Range:	Power Graph & Metrics   CDP Graph & CDE Graph   I/Q Error (Quad View)   Code Domain (Quad View)   Demod Bits
Example:	<b>:DISP:TCDP:VIEW SEVM</b>

## Terminal Modulation Accuracy Measurement - Select View

**:DISPlay:TRHO:VIEW POLar|ERRor|TABle|CDPower**

**:DISPlay:TRHO:VIEW?**

Allows you to select the desired measurement view from the following selections:

**I/Q Measured Polar Graph** - Provides a combination view of an I/Q measured polar vector graph and the summary data as shown below.

**Peak/Average Metrics** - Provides a table of magnitude error, phase error, EVM, and the modulation accuracy summary data such as rho, peak and rms EVM, peak Modulation Accuracy (Rho) error, magnitude error, phase error, and so forth in a text window, in terms of averaged and detected peak/maximum value in the average cycle.

**I/Q Error (Quad View)** - Provides a combination view of a magnitude error, phase error, EVM graphs.

**Code Domain Power** - Provides a code domain power graph and a table of summary data for the code domain channels is provided in the text window.

Key Path:	<b>View/Trace</b>
Preset:	POLar
State Saved:	Saved in instrument state.
Range:	I/Q Measured Polar Graph   Peak/Avg Metrics   I/Q Error (Quad View)   Code Domain Power
Example:	:DISP:TRHO:VIEW TAB

## Turn a Trace Display On/Off

**:DISPlay:TRACe[n] [:STATe] OFF|ON|0|1**

**:DISPlay:TRACe[n] [:STATe] ?**

Controls whether the specified trace is visible or not.

n is a sub-opcode that is valid for the current measurement. See the [“MEASure Group of Commands” on page 375](#) for more information about sub-opcodes.

Factory Preset: On

Range: The valid traces and their sub-opcodes are dependent upon the selected measurement. See the following table.

The trace name assignment is independent of the window number.

Remarks: For E4406A to use this command, the appropriate mode should be selected with INSTRUMENT:SElect.

Remarks: For PSA you must be in the Basic, cdmaOne,cdma2000, 1xEV-DO, W-CDMA, GSM (w/EDGE), NADC, or PDC mode to use this command. Use INSTRUMENT:SElect to set the mode

Front Panel

Access: **Display, Display Traces**

Measurement	Available Traces	Markers Available?
ACP - adjacent channel power (Basic, cdmaOne, cdma2000, W-CDMA, iDEN (E4406A only), NADC, PDC modes)	no traces (n=0) <sup>a</sup> for I/Q points	no markers
BER - bit error rate (iDEN mode, E4406A only)	no traces (n=0) <sup>a</sup> for I/Q data	no markers
CDPower - code domain power (cdmaOne mode)	POWer (n=2) <sup>a</sup> TIMing (n=3) <sup>a</sup> PHASe (n=4) <sup>a</sup> (n=0) <sup>a</sup> for I/Q points	yes
CDPower - code domain power (cdma2000, 1xEV-DO, W-CDMA modes)	(n=0) <sup>a</sup> for I/Q raw data CDPower (n=2) <sup>a</sup> EVM (n=5) <sup>a</sup> MERRor (n=6) <sup>a</sup> PERRor (n=7) <sup>a</sup> SPOWer (n=9) <sup>a</sup> CPOWer (n=10) <sup>a</sup>	yes
CHPower - channel power (Basic, cdmaOne, cdma2000, 1xEV-DO, W-CDMA modes)	SPECtrum (n=2) <sup>a</sup> (n=0) <sup>a</sup> for I/Q raw data	no markers



Measurement	Available Traces	Markers Available?
CSPur - spurs close (cdmaOne mode)	SPECTrum (n=2) <sup>a</sup> ULIMit (n=3) <sup>a</sup> (n=0) <sup>a</sup> for I/Q points	yes
EEVM - EDGE error vector magnitude (EDGE mode)	EVMError (n=2) <sup>a</sup> MERRor (n=3) <sup>a</sup> PERRor (n=4) <sup>a</sup> (n=0) <sup>a</sup> for I/Q points	yes
EORFspectr - EDGE output RF spectrum (EDGE mode)	RFEMod (n=2) <sup>a</sup> RFESwitching (n=3) <sup>a</sup> SPEMod (n=4) <sup>a</sup> LIMMod (n=5) <sup>a</sup> (n=0) <sup>a</sup> for I/Q points	yes, only for a single offset  yes, only for multiple offsets
EPVTime - EDGE power versus time (EDGE mode)	RFENvelope (n=2) <sup>a</sup> UMASk (n=3) <sup>a</sup> LMASk (n=4) <sup>a</sup> (n=0) <sup>a</sup> for I/Q points	yes
ETSPur - EDGE transmit band spurs (EDGE mode)	SPECTrum (n=2) <sup>a</sup> ULIMit (n=3) <sup>a</sup> (n=0) <sup>a</sup> for I/Q points	yes
EVM - error vector magnitude (NADC, PDC modes)	EVM (n=2) <sup>a</sup> MERRor (n=3) <sup>a</sup> PERRor (n=4) <sup>a</sup> (n=0) <sup>a</sup> for I/Q points	yes
EVMQpsk - QPSK error vector magnitude (cdma2000, 1xEV-DO, W-CDMA modes)	EVM (n=2) <sup>a</sup> MERRor (n=3) <sup>a</sup> PERRor (n=4) <sup>a</sup> (n=0) <sup>a</sup> for I/Q raw data	yes

Measurement	Available Traces	Markers Available?
IM - intermodulation (cdma2000, 1xEV-DO, W-CDMA modes)	SPECtrum (n=2) <sup>a</sup> (n=0) <sup>a</sup> for I/Q raw data	yes
MCPower - multi-carrier power (W-CDMA mode)	no traces (n=0) <sup>a</sup> for I/Q points	no markers
OBW - occupied bandwidth (cdmaOne, cdma2000, 1xEV-DO, iDEN (E4406A only), PDC, W-CDMA modes)	no traces (n=0) <sup>a</sup> for I/Q raw data	no markers
ORFSpectrum - output RF spectrum (GSM, EDGE mode)	RFEMod (n=2) <sup>a</sup> RFESwitching (n=3) <sup>a</sup> SPEMod (n=4) <sup>a</sup> LIMMod (n=5) <sup>a</sup> (n=0) <sup>a</sup> for I/Q points	yes, only for a single offset  yes, only for multiple offsets
PFERror - phase and frequency error (GSM, EDGE mode)	PERRor (n=2) <sup>a</sup> PFERror (n=3) <sup>a</sup> RFENvelope (n=4) <sup>a</sup> (n=0) <sup>a</sup> for I/Q points	yes
PStatistic - power statistics CCDF (Basic, cdma2000, 1xEV-DO, W-CDMA modes)	MEASured (n=2) <sup>a</sup> GAUSian (n=3) <sup>a</sup> REFerence (n=4) <sup>a</sup> (n=0) <sup>a</sup> for I/Q points	yes
PVTime - power versus time (GSM, EDGE, 1xEV-DO, Service (E4406A only) modes)	(n=0) <sup>a</sup> for I/Q raw data RFENvelope (n=2) <sup>a</sup> UMASk (n=3) <sup>a</sup> LMASk (n=4) <sup>a</sup>	yes

Measurement	Available Traces	Markers Available?
RHO - modulation quality (cdmaOne, cdma2000, W-CDMA mode)	(n=0) <sup>a</sup> for I/Q raw data EVM (n=2) <sup>a</sup> MERRor (n=3) <sup>a</sup> PERRor (n=4) <sup>a</sup> (n=5) <sup>a</sup> for I/Q corrected trace data	yes
RHO - modulation quality (1xEV-DO mode)	(n=0) <sup>a</sup> for I/Q raw data (n=1) <sup>a</sup> for various summary results EVM (n=2) <sup>a</sup> MERRor (n=3) <sup>a</sup> PERRor (n=4) <sup>a</sup> (n=5) <sup>a</sup> for I/Q corrected trace data	yes
SEMask - spectrum emissions mask (cdma2000, 1xEV-DO, W-CDMA mode)	SPECTrum (n=2) <sup>a</sup> (n=0) <sup>a</sup> for I/Q raw data	yes
TSPur - transmit band spurs (GSM, EDGE mode)	SPECTrum (n=2) <sup>a</sup> ULIMit (n=3) <sup>a</sup> (n=0) <sup>a</sup> for I/Q points	yes
TXPower - transmit power (GSM, EDGE mode)	RFENvelope (n=2) <sup>a</sup> IQ (n=8) <sup>a</sup> (n=0) <sup>a</sup> for I/Q points	yes

Measurement	Available Traces	Markers Available?
SPECtrum - (frequency domain) (all modes)	RFENvelope (n=2) <sup>a</sup> for Service mode (E4406A only)  IQ (n=3) <sup>a</sup>  SPECtrum (n=4) <sup>a</sup>  ASpectrum (n=7) <sup>a</sup>  (n=0) <sup>a</sup> for I/Q raw data	yes
WAVEform - (time domain) (all modes)	RFENvelope (n=2) <sup>a</sup> (also for Signal Envelope trace)  IQ (n=5) <sup>a</sup>  (n=0) <sup>a</sup> for I/Q raw data	yes

a. The n number indicates the sub-opcode that corresponds to this trace. Detailed descriptions of the trace data can be found in the MEASure subsystem documentation by looking up the sub-opcode for the appropriate measurement.

## Waveform - Y-Axis Scale/Div

**:DISPlay:WAVEform[n]:WINDow[m]:TRACe:Y[:SCALE]:PDIVision  
 <power>**

**:DISPlay:WAVEform[n]:WINDow[m]:TRACe:Y[:SCALE]:PDIVision?**

Sets the scale per division for the y-axis.

n, selects the view, the default is RF envelope.

n=1, m=1 RF envelope

n=2, m=1 I/Q Waveform

n=2, m=1 I and Q Waveform (Option B7C, E4406A only)

n=4, m=1 I/Q Polar (Basic, W-CDMA, cdma2000)

n=5, m=1 Linear Envelope (Option B7C, E4406A only)

m, selects the window within the view. The default is 1.

Factory Preset: 10 dBm, for RF envelope

Range: .1 dB to 20 dB, for RF envelope

Default Unit: dBm, for RF envelope

Remarks: May affect input attenuator setting.

For E4406A to use this command, the appropriate mode should be selected with INSTRUMENT:SElect.

For PSA you must be in Basic, cdmaOne, cdma2000, 1xEV-DO, W-CDMA GSM w/EDGE, NADC, or PDC mode. Set the mode with INSTRUMENT:SElect.

Front Panel

Access: When in Waveform measurement: **Amplitude Y Scale, Scale/Div.**

History: For PSA:  
Added revision A.02.00

For E4406A:  
Modified revision A.05.00

## Waveform - Y-Axis Reference Level

```
:DISPlay:WAVEform[n]:WINDow[m]:TRACe:Y[:SCALE]:RLEVEL
<power>
```

```
:DISPlay:WAVEform[n]:WINDow[m]:TRACe:Y[:SCALE]:RLEVEL?
```

Sets the amplitude reference level for the y-axis.

n, selects the view, the default is RF envelope.

n=1, m=1 RF envelope

n=2, m=1 I/Q Waveform

n=2, m=1 I and Q Waveform (Option B7C, E4406A only)

n=4, m=1 I/Q Polar (Basic, W-CDMA, cdma2000)

n=5, m=1 Linear Envelope (Option B7C, E4406A only)

m, selects the window within the view. The default is 1.

Factory Preset: 0 dBm, for RF envelope

Range: -250 to 250 dBm, for RF envelope

Default Unit: dBm, for RF envelope

Remarks: May affect input attenuator setting.

For E4406A to use this command, the appropriate mode should be selected with INSTRUMENT:SElect.

Programming Commands  
**DISPlay Subsystem**

For PSA you must be in Basic, cdmaOne, cdma2000, 1xEV-DO, W-CDMA GSM w/EDGE, NADC, or PDC mode. Set the mode with INSTRument:SElect.

Front Panel

Access: When in Waveform measurement: **Amplitude Y Scale, Ref Level**

History: For PSA:  
Added revision A.02.00  
For E4406A:  
Modified revision A.05.00

---

## FETCh Subsystem

The FETCh? queries are used with several other commands to control the measurement process. These commands are described in the section on the “MEASure Group of Commands” on page 375. These commands apply only to measurements found in the MEASURE menu.

This command puts selected data from the most recent measurement into the output buffer (new data is initiated/measured). Use FETCh if you have already made a good measurement and you want to look at several types of data (different [n] values) from the single measurement. FETCh saves you the time of re-making the measurement. You can only fetch results from the measurement that is currently active.

If you need to make a new measurement, use the READ command, which is equivalent to an INITiate[:IMMEDIATE] followed by a FETCh.

:FETCh <meas>? will return valid data only when the measurement is in one of the following states:

- idle
- initiated
- paused

### Fetch the Current Measurement Results

**:FETCh: <measurement> [n] ?**

A FETCh? command must specify the desired measurement. It will return the valid results that are currently available, but will not initiate the taking of any new data. You can only fetch results from the measurement that is currently selected. The code number n selects the kind of results that will be returned. The available measurements and data results are described in the “MEASure Group of Commands” on page 375.

## FORMat Subsystem

The FORMat subsystem sets a data format for transferring numeric and array information. For PSA the TRACe[:DATA] command is affected by FORMat subsystem commands.

### Byte Order

**:FORMat:BORDER NORMAl | SWAPped**

**:FORMat:BORDER?**

Selects the binary data byte order for numeric data transfer. In normal mode the most significant byte is sent first. In swapped mode the least significant byte is first. (PCs use the swapped order.) Binary data byte order functionality does not apply to ASCII.

Factory Preset: Normal

Remarks: You must be in the Basic, cdma2000, 1xEV-DO, W-CDMA, GSM (w/EDGE), NADC, or PDC mode to use this command. Use INSTRument:SElect to set the mode.

### Numeric Data Format

PSA/VSA Basic, cdmaOne, cdma2000, 1xEV-DO, W-CDMA, GSM, EDGE, NADC, PDC modes:

**:FORMat[:DATA] ASCii | REAL, 32 | REAL, 64**

**:FORMat[:DATA]?**

PSA Spectrum Analysis mode only:

**:FORMat[:TRACe][:DATA]  
ASCii | INTEger, 16 | INTEger, 32 | REAL, 32 | REAL, 64 | UINTEger, 16**

**:FORMat[:TRACe][:DATA]?**

PSA Noise Figure mode only:

**:FORMat[:TRACe][:DATA] ASCii | REAL[, 32]**

**:FORMat[:TRACe][:DATA]?**

VSA/PSA application modes: This command controls the format of data input/output, that is any data transfer across any remote port. The REAL and ASCII formats will format data in the current display units. The format of state data cannot be changed. It is always in a machine



readable format only.

ASCII - Amplitude values are in ASCII, in amplitude units, separated by commas. ASCII format requires more memory than the binary formats. Therefore, handling large amounts of this type of data, will take more time and storage space.

Integer,16 - Binary 16-bit integer values in internal units (dBm), in a definite length block. \*\*PSA, SA mode only.

Integer,32 - Binary 32-bit integer values in internal units (dBm), in a definite length block.

Real,32 or Real,64 - Binary 32-bit (or 64-bit) real values in amplitude unit, in a definite length block. Transfers of real data are done in a binary block format.

UINTeger,16 - Binary 16-bit unsigned integer that is uncorrected ADC values, in a definite length block. This format is almost never applicable with current measurement data.

A definite length block of data starts with an ASCII header that begins with # and indicates how many additional data points are following in the block. Suppose the header is #512320.

- The first digit in the header (5) tells you how many additional digits/bytes there are in the header.
- The 12320 means 12 thousand, 3 hundred, 20 data bytes follow the header.
- Divide this number of bytes by your selected data format bytes/point, either 8 (for real 64), or 4 (for real 32). In this example, if you are using real 64 then there are 1540 points in the block.

Example:       FORM REAL,64

Factory Preset: ASCII

Real,32 for Spectrum Analysis mode

ASCII for Basic, cdmaOne, cdma2000, 1xEV-DO, W-CDMA, GSM with EDGE, NADC, PDC modes

Remarks:       The acceptable settings for this command change for the different modes as described above.

---

## INITiate Subsystem

The INITiate subsystem is used to initiate a trigger for a measurement. They only initiate measurements from the MEASURE front panel key or the “MEASure Group of Commands” on page 375. Refer to the TRIGger and ABORt subsystems for related commands.

### Take New Data Acquisition for Selected Measurement

**:INITiate:<measurement>**

For PSA this command is not available for measurements in the instrument modes: Spectrum Analysis, or Phase Noise.

This command initiates a trigger cycle for the measurement specified, but does not return data. The available measurement names are described in the MEASure subsystem..

If your selected measurement is not currently active it will change to the measurement in your INIT:<meas> command and initiate a trigger cycle.

Example:       INIT:ACP

### Continuous or Single Measurements

**:INITiate:CONTinuous OFF|ON|0|1**

**:INITiate:CONTinuous?**

Selects whether a trigger is continuously initiated or not. Each trigger initiates a single, complete, measurement operation.

When set to ON another trigger cycle is initiated at the completion of each measurement.

When set to OFF, the trigger system remains in the “idle” state until an INITiate[:IMMediate] command is received. On receiving the INITiate[:IMMediate] command, it will go through a single trigger/measurement cycle, and then return to the “idle” state.

Example:       INIT:CONT ON

Factory Preset: On

\*RST:           Off (recommended for remote operation)

Front Panel

Access:         **Meas Control, Measure Cont Single**

## Take New Data Acquisitions

### **:INITiate[:IMMediate]**

The instrument must be in the single measurement mode. If INIT:CONT is ON, then the command is ignored. The desired measurement must be selected and waiting. The command causes the system to exit the “waiting” state and go to the “initiated” state.

The trigger system is initiated and completes one full trigger cycle. It returns to the “waiting” state on completion of the trigger cycle. Depending upon the measurement and the number of averages, there may be multiple data acquisitions, with multiple trigger events, for one full trigger cycle.

This command triggers the instrument, if external triggering is the type of trigger event selected. Otherwise, the command is ignored. Use the TRIGer[:SEQuence]:SOURce EXT command to select the external trigger.

Example:       INIT:IMM

Remarks:       See also the \*TRG command and the TRIGger subsystem.

Front Panel

Access:         **Meas Control, Measure Cont Single**

## Restart the Measurement

### **:INITiate:REStart**

This command applies to measurements found in the MEASURE menu. It restarts the current measurement from the “idle” state regardless of its current operating state. It is equivalent to:

INITiate[:IMMediate]

ABORt (for continuous measurement mode)

Example:       INIT:REST

Front Panel

Access:         **Restart**

or

**Meas Control, Restart**

---

## INSTRUMENT Subsystem

This subsystem includes commands for querying and selecting instrument measurement (personality option) modes.

### Catalog Query

For E4406A, **:INSTRUMENT:CATALOG[:FULL]?**

For PSA, **:INSTRUMENT:CATALOG?**

Returns a comma separated list of strings which contains the names of all the installed applications. These names can only be used with the **INST:SELECT** command.

For E4406A if the optional keyword **FULL** is specified, each name is immediately followed by its associated instrument number. These instrument numbers can only be used with the **INST:NSELECT** command.

Example:

(PSA)           INST:CAT?

Query response: "CDMA"4,"PNOISE"14

Example:

(E4406A)       INST:CAT:FULL?

Query response:  
"BASIC"8,"GSM"3,"CDMA"4,"SERVICE"1

### Select Application by Number

**:INSTRUMENT:NSELECT <integer>**

**:INSTRUMENT:NSELECT?**

Select the measurement mode by its instrument number. The actual available choices depends upon which applications are installed in the instrument. For E4406A these instrument numbers can be obtained with **INST:CATALOG:FULL?**

- 1 = SA (PSA/ESA)
- 1 = SERVICE (E4406A)
- 3 = GSM (GSM on E4406A, and GSM or GSM w/EDGE on ESA)
- 4 = CDMA (cdmaOne) (E4406/ESA/PSA)
- 5 = NADC (E4406/PSA)
- 6 = PDC (E4406/PSA)
- 8 = BASIC (E4406/PSA)
- 9 = WCDMA (3GPP W-CDMA with HSDPA) (E4406/PSA)

- 10 = CDMA2K (cdma2000 with 1xEV-DV) (E4406/PSA)
- 11 = IDEN (E4406A)
- 12 = WIDEN (E4406A)
- 13 = EDGE GSM (E4406/PSA)
- 14 = PNOISE (phase noise) (ESA/PSA)
- 15 = CMDA1XEV (1xEV-D0) (E4406/PSA)
- 18 = WLAN (PSA/VSA)
- 211 = TDSCDMA (PSA)
- 215 = HYPNO???(PSA)
- 241 = DMODULATION (PSA)
- 219 = NOISEFIGURE (ESA/PSA)
- 231 = LINK (89600 VSA Link Software) (PSA/ESA)
- 266 = (8566/68, 8560 Series, and 8590 Series Programming Compatibility) (PSA)

**NOTE**

If you are using the SCPI status registers and the analyzer mode is changed, the status bits should be read, and any errors resolved, prior to switching modes. Error conditions that exist prior to switching modes cannot be detected using the condition registers after the mode change. This is true unless they recur after the mode change, although transitions of these conditions can be detected using the event registers.

Changing modes resets all SCPI status registers and mask registers to their power-on defaults. Hence, any event or condition register masks must be re-established after a mode change. Also note that the power up status bit is set by any mode change, since that is the default state after power up.

Example:       INST:NSEL 4

Factory Preset: Persistent state with factory default of 1 (PSA/ESA)  
                   Persistent state with factory default of 8  
                   (E4406A, BASIC)

Range:           1 to x, where x depends upon which applications are installed.

Front Panel  
 Access:         **MODE**

## Select Application

VSA E4406A:

**:INSTRument [:SElect]**  
**BASIC | SERVICE | CDMA | CDMA2K | GSM | EDGE GSM | IDEN | NADC | PDC |**  
**WCDMA | CDMA1XEV**

PSA Series:

```
:INSTrument [:SElect]  
SA | PNOISE | BASIC | CDMA | CDMA2K | EDGE GSM | NADC | PDC | WCDMA | CDMA1XEV  
| NFIGURE | WLAN | TDSCDMA
```

```
:INSTrument [:SElect]?
```

Select the measurement mode. The actual available choices depend upon which modes (measurement applications) are installed in the instrument. A list of the valid choices is returned with the INST:CAT? query.

Once an instrument mode is selected, only the commands that are valid for that mode can be executed.

---

**NOTE**

If you are using the status bits and the analyzer mode is changed, the status bits should be read, and any errors resolved, prior to switching modes. Error conditions that exist prior to switching modes cannot be detected using the condition registers after the mode change. This is true unless they recur after the mode change, although transitions of these conditions can be detected using the event registers.

Changing modes resets all SCPI status registers and mask registers to their power-on defaults. Hence, any event or condition register masks must be re-established after a mode change. Also note that the power up status bit is set by any mode change, since that is the default state after power up.

---

Example:       ESA Series instruments: INST:SEL 'CDMA'

Example:       PSA Series instruments: INST:SEL CDMA

Factory Preset:  
(PSA/ESA)      Persistent state with factory default of Spectrum  
Analyzer mode

Factory Preset:  
(E4406A)       Persistent state with factory default of Basic mode.

Front Panel  
Access:        **MODE**

---

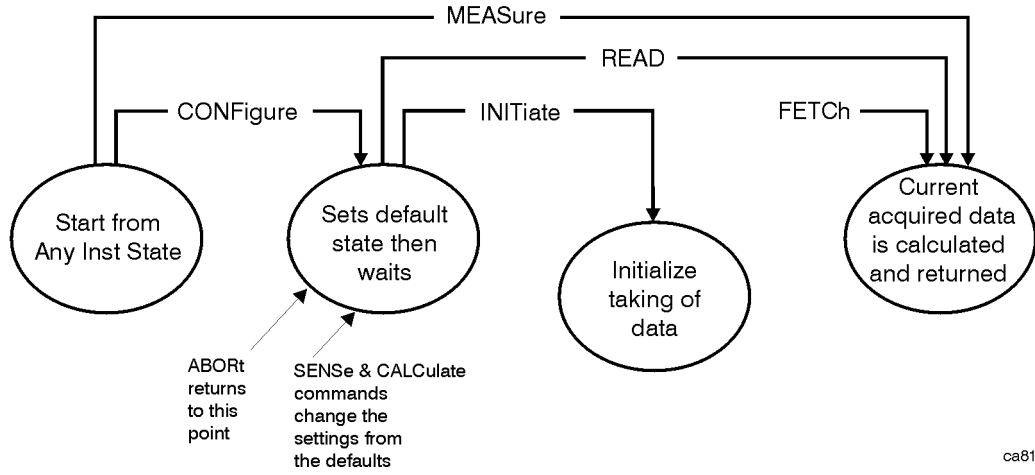
## MEASure Group of Commands

This group includes the CONFigure, FETCh, MEASure, and READ commands that are used to make measurements and return results. The different commands can be used to provide fine control of the overall measurement process, like changing measurement parameters from their default settings. Most measurements should be done in single measurement mode, rather than measuring continuously.

The SCPI default for the format of any data output is ASCII. The format can be changed to binary with FORMat:DATA which transports faster over the bus.

## Command Interactions: MEASure, CONFigure, FETCh, INITiate and READ

Figure 1 Measurement Group of Commands



ca81a



Measure Commands:

`:MEASure:<measurement>[n]?`

This is a fast single-command way to make a measurement using the factory default instrument settings. These are the settings and units that conform to the Mode Setup settings (e.g. radio standard) that you have currently selected.

- Stops the current measurement (if any) and sets up the instrument for the specified measurement using the factory defaults
- Initiates the data acquisition for the measurement
- Blocks other SCPI communication, waiting until the measurement is complete before returning results.
- After the data is valid it returns the scalar results, or the trace data, for the specified measurement. The type of data returned may be defined by an [n] value that is sent with the command.

The scalar measurement results will be returned if the optional [n] value is not included, or is set to 1. If the [n] value is set to a value other than 1, the selected trace data results will be returned. See each command for details of what types of scalar results or trace data results are available.

ASCII is the default format for the data output. (Older versions of Spectrum Analysis and Phase Noise mode measurements only use ASCII.) The binary data formats should be used for handling large blocks of data since they are smaller and faster than the ASCII format. Refer to the `FORMat:DATA` command for more information.

If you need to change some of the measurement parameters from the factory default settings you can set up the measurement with the `CONFigure` command. Use the commands in the `SENSE:<measurement>` and `CALCulate:<measurement>` subsystems to change the settings. Then you can use the `READ?` command to initiate the measurement and query the results. See [Figure 1](#).

If you need to repeatedly make a given measurement with settings other than the factory defaults, you can use the commands in the `SENSE:<measurement>` and `CALCulate:<measurement>` subsystems to set up the measurement. Then use the `READ?` command to initiate the measurement and query results.

Measurement settings persist if you initiate a different measurement and then return to a previous one. Use `READ:<measurement>?` if you want to use those persistent settings. If you want to go back to the default settings, use `MEASure:<measurement>?`.

Configure Commands:

**:CONFigure: <measurement>**

This command stops the current measurement (if any) and sets up the instrument for the specified measurement using the factory default instrument settings. It sets the instrument to single measurement mode but should not initiate the taking of measurement data unless INIT:CONTinuous is ON. After you change any measurement settings, the READ command can be used to initiate a measurement without changing the settings back to their defaults.

**NOTE** In instruments with firmware older than A.05.00 CONFigure initiates the taking of data. The data should be ignored. Other SCPI commands can be processed immediately after sending CONFigure. You do not need to wait for the CONF command to complete this 'false' data acquisition.

The CONFigure? query returns the current measurement name.

Fetch Commands:

**:FETCh: <measurement> [n] ?**

This command puts selected data from the most recent measurement into the output buffer. Use FETCh if you have already made a good measurement and you want to return several types of data (different [n] values, e.g. both scalars and trace data) from a single measurement. FETCh saves you the time of re-making the measurement. You can only FETCh results from the measurement that is currently active, it will not change to a different measurement.

If you need to get new measurement data, use the READ command, which is equivalent to an INITiate followed by a FETCh.

The scalar measurement results will be returned if the optional [n] value is not included, or is set to 1. If the [n] value is set to a value other than 1, the selected trace data results will be returned. See each command for details of what types of scalar results or trace data results are available. The binary data formats should be used for handling large blocks of data since they are smaller and transfer faster than the ASCII format. (FORMat:DATA)

FETCh may be used to return results other than those specified with the original READ or MEASure command that you sent.

INITiate Commands:

**:INITiate:<measurement>**

This command is not available for measurements in all the instrument modes:

- Initiates a trigger cycle for the specified measurement, but does not output any data. You must then use the FETCh<meas> command to return data. If a measurement other than the current one is specified, the instrument will switch to that measurement and then initiate it.  
 For example, suppose you have previously initiated the ACP measurement, but now you are running the channel power measurement. If you send INIT:ACP? it will change from channel power to ACP and will initiate an ACP measurement.
- Does not change any of the measurement settings. For example, if you have previously started the ACP measurement and you send INIT:ACP? it will initiate a new ACP measurement using the same instrument settings as the last time ACP was run.
- If your selected measurement is currently active (in the idle state) it triggers the measurement, assuming the trigger conditions are met. Then it completes one trigger cycle. Depending upon the measurement and the number of averages, there may be multiple data acquisitions, with multiple trigger events, for one full trigger cycle. It also holds off additional commands on GPIB until the acquisition is complete.

READ Commands:

**:READ:<measurement> [n]?**

- Does not preset the measurement to the factory default settings. For example, if you have previously initiated the ACP measurement and you send READ:ACP? it will initiate a new measurement using the same instrument settings.
- Initiates the measurement and puts valid data into the output buffer. If a measurement other than the current one is specified, the instrument will switch to that measurement before it initiates the measurement and returns results.  
 For example, suppose you have previously initiated the ACP measurement, but now you are running the channel power measurement. Then you send READ:ACP? It will change from channel power back to ACP and, using the previous ACP settings, will initiate the measurement and return results.
- Blocks other SCPI communication, waiting until the measurement is complete before returning the results

If the optional [n] value is not included, or is set to 1, the scalar measurement results will be returned. If the [n] value is set to a value other than 1, the selected trace data results will be returned. See each command for details of what types of scalar results or trace data results are available. The binary data formats should be used when handling large blocks of data since they are smaller and faster than the ASCII format. (FORMat:DATA)

## Code Domain Power Measurement

This measures the power levels of the spread channels in RF channel(s). You must be in the cdmaOne, cdma2000, W-CDMA, or 1xEV-DO mode to use these commands. Use INSTRUMENT:SElect to set the mode.

For 1xEV-DO, this measurement is used only for base stations (Network Access). When measuring 1xEV-DO mobile stations (Access Terminals) use Terminal Code Domain Measurements (MEAS:TCDPower) and set SENSE:RADio:DEvice to MS.

The general functionality of CONFigure, FETCh, MEASure, and READ are described at the beginning of this section. See the SENSE:CDPower commands for more measurement related commands.

```
:CONFigure:CDPower
:INITiate:CDPower
:FETCh:CDPower [n] ?
:READ:CDPower [n] ?
:MEASure:CDPower [n] ?
```

Front Panel

Access: **Measure, Code Domain**

After the measurement is selected, press **Restore Meas Defaults** to restore factory defaults.

### Measurement Results Available

n	Results Returned
0	Returns unprocessed I/Q trace data, as a series of trace point values, in volts. The I values are listed first in each pair, using the 0 through even-indexed values. The Q values are the odd-indexed values.

n	Results Returned
<p>n=1 (or not specified)</p> <p>1xEV-DO mode</p>	<p>Returns the following 18 comma-delimited scalar results, in the following order:</p> <ol style="list-style-type: none"> <li>1. Total power is a floating point number (in dBm) of the total RF power over the measurement interval.  NOTE: The following power results are computed by the CDP measurement. The unit used in the computation, either dB or dBm, is determined by the setting of the <b>CALCulate:CDPower:TYPE</b> command. When the selection is <b>ABSolute</b>, the unit used is dBm. When the selection is <b>RELative</b>, the unit used is dB relative to Total Power (above).</li> <li>2. Total active power is a floating point number (in dB or dBm depending on the measurement type) of the sum of the active powers (–.999.0 when no active channel is detected).</li> <li>3. Maximum active power is a floating point number (in dB or dBm depending on the measurement type) of the maximum average power of the active code (–.999.0 when no active channel is detected in I/Q Combined=On mode. Always –.999.0 in I/Q Combined=Off mode)</li> <li>4. Average active power is a floating point number (in dB or dBm depending on the measurement type) of the average power of all the active traffic channels (–.999.0 when no active channel is detected in I/Q Combined=On mode. Always –.999.0 in I/Q Combined=Off mode).</li> <li>5. Maximum inactive power is a floating point number (in dB or dBm depending on the measurement type) of the maximum average power of the inactive traffic channels. ( –.999.0 in I/Q Combined=Off mode)</li> <li>6. Average inactive power is a floating point number (in dB or dBm depending on the measurement type) of the average power of the inactive traffic channels. ( –.999.0 in I/Q Combined=Off mode)</li> <li>7. Number of active channels</li> <li>8. I channel average active power is a floating point number (in dB or dBm depending on the measurement type) of the average power of the active I channels. (–.999.0 when I/Q Combined=On mode or when no active channel is detected in I/Q Combined=Off mode).</li> <li>9. I channel maximum inactive power is a floating point number (in dB or dBm depending on the measurement type) of the maximum average power of the inactive I channels. (–.999.0 when I/Q Combined=On mode)</li> <li>10. Q channel average active power is a floating point number (in dB or dBm depending on the measurement type) of the average power of the active Q channels. (–.999.0 when I/Q Combined=On mode or when no active channel is detected in I/Q Combined=Off mode).</li> <li>11. Q channel maximum inactive power is a floating point number (in dB or dBm depending on the measurement type) of the maximum average power of the inactive Q channels. (–.999.0 when I/Q Combined=On mode)</li> </ol> <p>(Continued Next Page)</p>

<b>n</b>	<b>Results Returned</b>
<p>n=1 (or not specified)            (Continued)</p>	<p>12. Preamble Length is a floating point number (in chips).            13. Preamble MAC Index is an integer number of MAC index.            14. Minimum Active Power is a floating point number (in dB or dBm depending on the measurement type) of the minimum average power of the active code (-.999.0 when no active channel is detected in I/Q Combined=On mode. Always -.999.0 in I/Q Combined=Off mode)            15. I channel maximum active power is a floating point number (in dB or dBm depending on the measurement type) of the maximum average power of the active I channels. (-.999.0 when I/Q Combined=On mode)            16. I channel minimum active power is a floating point number (in dB or dBm depending on the measurement type) of the minimum average power of the active I channels. (-.999.0 when I/Q Combined=On mode)            17. Q channel maximum active power is a floating point number (in dB or dBm depending on the measurement type) of the maximum average power of the active Q channels. (-.999.0 when I/Q Combined=On mode)            18. Q channel minimum active power is a floating point number (in dB or dBm depending on the measurement type) of the minimum average power of the active Q channels. (-.999.0 when I/Q Combined=On mode)</p>

<b>n</b>	<b>Results Returned</b>
2	<p>Returns a series of floating point numbers (in dB or dBm depending on the measurement type) that represents all the code domain powers.</p> <p>When I/Q Combined=On, total is 16 for Data, 32 for Pilot. For MAC channel, total is 64 with Subtype 0/1 and it is 128 with Subtype 2. If the active channel occupies more than the max spreading factor (16 for Data, 32 for Pilot, and 64 with Subtype 0/1 or 128 with Subtype 2 for MAC) the power is duplicated.</p> <p>1st number = 1st code power over the slot            2nd number = 2nd code power over the slot            ...            Nth number = Nth code power over the slot</p> <p>When I/Q Combined=Off, results are returned alternatively. Total is 16 I/Q pairs for Data, 32 for Pilot, and 64 with Subtype 0/1 or 128 with Subtype 2 for MAC. If the active channel occupies more than the max spreading factor (16 for Data, 32 for Pilot, and 64 with Subtype 0/1 or 128 with Subtype 2 for MAC) the power is duplicated.</p> <p>1st number = 1st in-phase code power over the slot            2nd number = 1st quad-phase code power over the slot            ...            (2*N-1)th number = Nth in-phase code power over the slot            (2*N)th number = Nth quad-phase code power over a slot</p> <p>N = the number of codes detected. The total number of codes varies because of the different symbol rates of each code.</p>

<b>n</b>	<b>Results Returned</b>
3	<p>Returns a series of floating point numbers (in dB or dBm depending on the measurement type) that represents all the code domain symbol rates.</p> <p>When I/Q Combined=On, total is 16 for Data, 32 for Pilot, and 64 for MAC. If the active channel occupies more than the max spreading factor (16 for Data, 32 for Pilot, and 64 for MAC) the power is duplicated.</p> <p>1st number = 1st code symbol rate over the slot            2nd number = 2nd code symbol rate over the slot            ...            Nth number = Nth code symbol rate over the slot</p> <p>When I/Q Combined=Off, results are returned alternatively. Total is 16 I/Q pairs for Data, 32 for Pilot, and 64 for MAC. If the active channel occupies more than the max spreading factor (16 for Data, 32 for Pilot, and 64 for MAC) the power is duplicated.</p> <p>1st number = 1st in-phase code symbol rate over the slot            2nd number = 1st quad-phase code symbol rate over the slot            ...            (2×N-1)th number = Nth in-phase code symbol rate over the slot            (2×N)th number = Nth quad-phase code symbol rate over a slot</p> <p>N = the number of codes detected. The total number of codes varies because of the different symbol rates of each code.</p>
4	<p>Returns a series of floating point numbers that show either active or inactive status for each of the code powers returned in n=2 and 3. If a code is inactive, the value returned is 0.0, otherwise a value &gt;0.0 is returned.</p> <p>When I/Q Combined=On, I/Q combined results are returned.</p> <p>1st number = active or inactive flag of the 1st code            ...            Nth number = active or inactive flag of the Nth code</p> <p>When channel type=Pilot or MAC, results are returned alternatively.</p> <p>1st number = 1st in-phase code active flag            2nd number = 1st Quad Phase code active flag            ...            (2×N-1)th number = Nth in-phase code active flag            (2×N)th number = Nth Quad Phase code active flag</p> <p>N = the number of codes detected. The total number of codes varies because of the different symbol rates of each code.</p> <p>2nd number = 1st quad-phase code symbol rate over the slot</p>



<b>n</b>	<b>Results Returned</b>
5	<p>Returns series of floating point numbers that alternately represent I and Q pairs of the corrected measured trace. The magnitude of each I and Q pair is normalized to 1.0. The first number is the in-phase (I) sample of symbol 0 decision point and the second is the quadrature-phase (Q) sample of symbol 0 decision point. As in the EVM, there are X points per symbol, so that:</p> <p style="padding-left: 40px;">1st number is I of the symbol 0 decision point            2nd number is Q of the symbol 0 decision point            ...            (2×X)+1 number is I of the symbol 1 decision point            (2×X)+2 number is Q of the symbol 1 decision point            ...            (2×X)×N+1th number is I of the symbol N decision point            (2×X)×N+2th number is Q of the symbol N decision point</p> <p>where X = the number of points per symbol, and            N = the number of symbols</p>
6	<p>Returns series of floating point numbers (in dBm) that represent the trace data of the chip power vs. time.</p>

## Channel Power Measurement

For E4406A this measures the total rms power in a specified integration bandwidth. You must be in the Basic, cdmaOne, cdma2000, W-CDMA, or 1xEV-DO mode to use these commands. Use INSTRument:SElect to set the mode.

For PSA this measures the total rms power in a specified integration bandwidth. You must be in the cdmaOne, cdma2000, or W-CDMA, or 1xEV-DO mode to use these commands. Use INSTRument:SElect to set the mode.

The general functionality of CONFigure, FETCh, MEASure, and READ are described at the beginning of this section. See the SENSE:CHPower commands for more measurement related commands.

```
:CONFigure:CHPower
:INITiate:CHPower
:FETCh:CHPower [n] ?
:READ:CHPower [n] ?
:MEASure:CHPower [n] ?
```

History: For E4406A:  
 Added to Basic mode, version A.03.00 or later

Front Panel

Access: **Measure, Channel Power**

After the measurement is selected, press **Restore Meas Defaults** to restore factory defaults.

### Measurement Results Available

<b>n</b>	<b>Results Returned</b>
0	Returns unprocessed I/Q trace data, as a series of trace point values, in volts. The I values are listed first in each pair, using the 0 through even-indexed values. The Q values are the odd-indexed values.
n=1 (or not specified)	Returns 2 scalar results: <ol style="list-style-type: none"> <li>1. Channel Power is a floating point number representing the total channel power in the specified integration bandwidth.</li> <li>2. PSD (Power Spectral Density) is the power (in dBm/Hz) in the specified integration bandwidth.</li> </ol>
2	Returns floating point numbers that are the captured trace data of the power (in dBm/resolution BW) of the signal. The frequency span of the captured trace data is specified by the <b>Span</b> key.



## QPSK Error Vector Magnitude Measurement

This measures the QPSK error vector magnitude of each symbol. You must be in the cdma2000, W-CDMA, or 1xEV-DO mode to use these commands. Use INSTRument:SElect to set the mode.

The general functionality of CONFigure, FETCh, MEASure, and READ are described at the beginning of this section. See the SENSE:EVMQpsk commands for more measurement related commands.

**:CONFigure:EVMQpsk**

**:INITiate:EVMQpsk**

**:FETCh:EVMQpsk [n] ?**

**:READ:EVMQpsk [n] ?**

**:MEASure:EVMQpsk [n] ?**

History:           Version A.03.00 or later

Front Panel

Access:           **Measure, QPSK EVM**

After the measurement is selected, press **Restore Meas Defaults** to restore factory defaults.

### Measurement Results Available

<b>n</b>	<b>Results Returned</b>
0	Returns unprocessed I/Q trace data, as a data array of trace point values, in volts.

n	Results Returned
1 (default)	<p>Returns 11 scalar results, in the following order.</p> <ol style="list-style-type: none"> <li>1. RMS EVM is a floating point number (in percent) of EVM over the entire measurement area.</li> <li>2. RMS EVM maximum is the maximum RMS EVM over the averaged counts</li> <li>3. Peak EVM is a floating point number (in percent) of peak EVM in the measurement area.</li> <li>4. Peak EVM maximum is the maximum peak EVM over the averaged counts.</li> <li>5. Magnitude error is a floating point number (in percent) of average magnitude error over the entire measurement area.</li> <li>6. Magnitude error maximum is the maximum magnitude error over the averaged counts.</li> <li>7. Phase error is a floating point number (in degree) of average phase error over the entire measurement area.</li> <li>8. Phase error maximum is the maximum phase error over the averaged counts.</li> <li>9. Frequency error is a floating point number (in Hz) of the frequency error in the measured signal.</li> <li>10. Frequency error maximum is the maximum frequency error over the averaged counts.</li> <li>11. I/Q origin offset is a floating point number (in dB) of the I and Q error (magnitude squared) offset from the origin.</li> </ol>
2	<p>EVM trace – returns series of floating point numbers (in percent) that represent each sample in the EVM trace. The first number is the symbol 0 decision point. There are X points per symbol (X = points/chip). Therefore, the decision points are at 0, 1 × X, 2 × X, 3 × X . . .</p>
3	<p>Magnitude error trace – returns series of floating point numbers (in percent) that represent each sample in the magnitude error trace. The first number is the symbol 0 decision point. There are X points per symbol (X = points/chip). Therefore, the decision points are at 0, 1 × X, 2 × X, 3 × X . . .</p>
4	<p>Phase error trace – returns series of floating point numbers (in degree) that represent each sample in the phase error trace. There are X points per symbol (X = points/ chip). Therefore, the decision points are at 0, 1 × X, 2 × X, 3 × X . . .</p>

n	Results Returned
5	<p>Corrected measured trace – returns series of floating point numbers that alternately represent I and Q pairs of the corrected measured trace. The magnitude of each I and Q pair are normalized to 1.0. The first number is the in-phase (I) sample of symbol 0 decision point and the second is the quadrature-phase (Q) sample of symbol 0 decision point. There are X points per symbol (X = points/chip), so the series of numbers is:</p> <p>1st number = I of the symbol 0 decision point            2nd number = Q of the symbol 0 decision point</p> <p>.....  <math>(2 \times X) + 1</math>, number = I of the symbol 1 decision point  <math>(2 \times X) + 2</math>, number = Q of the symbol 1 decision point</p> <p>.....  <math>(2 \times X) \times Nth + 1</math> number = I of the symbol N decision point  <math>(2 \times X) \times Nth + 2</math> number = Q of the symbol N decision point</p>

## Intermodulation Measurement

This measures the third order and fifth order intermodulation products caused by the wanted signal and the interfering signal. You must be in cdma2000, W-CDMA, or 1xEV-DO mode to use these commands. Use INSTRument:SElect to set the mode.

The general functionality of CONFigure, FETCh, MEASure, and READ are described at the beginning of this section. See the SENSE:IM commands for more measurement related commands.

**:CONFigure:IM**

**:INITiate:IM**

**:FETCh:IM[n]?**

**:READ:IM[n]?**

**:MEASure:IM[n]?**

Front Panel

Access: **Measure, Intermod**

After the measurement is selected, press **Restore Meas Defaults** to restore factory defaults.

### Measurement Results Available

<b>n</b>	<b>Results Returned</b>
0	Returns unprocessed I/Q trace data that acquired in the last acquisition when multiple acquisition is performed, as a data array of trace point values, in volts.

n	Results Returned
1 (default)	<p>Returns 23 scalar results in the following order.</p> <ol style="list-style-type: none"> <li>1. Absolute power of the reference (dBm)</li> <li>2. Base lower frequency (Hz)</li> <li>3. Base lower absolute power (dBm)</li> <li>4. Base lower relative power to the reference (dBc)</li> <li>5. Base upper frequency (Hz)</li> <li>6. Base upper absolute power (dBm)</li> <li>7. Base upper relative power to the reference (dBc)</li> <li>8. Third order lower frequency (Hz)</li> <li>9. Third order lower absolute power (dBm)</li> <li>10. Third order lower relative power to the reference power (dBc)</li> <li>11. Third order lower power spectrum density (dBm/Hz)</li> <li>12. Third order upper frequency (Hz)</li> <li>13. Third order upper absolute power (dBm)</li> <li>14. Third order upper relative power to the reference power (dBc)</li> <li>15. Third order upper power spectrum density (dBm/Hz)</li> <li>16. Fifth order lower frequency (Hz)</li> <li>17. Fifth order lower absolute power (dBm)</li> <li>18. Fifth order lower relative power to the reference power (dBc)</li> <li>19. Fifth order lower power spectrum density (dBm/Hz)</li> <li>20. Fifth order upper frequency (Hz)</li> <li>21. Fifth order upper absolute power (dBm)</li> <li>22. Fifth order upper relative power to the reference power (dBc)</li> <li>23. Fifth order upper power spectrum density (dBm/Hz)</li> </ol> <p>If the results are not available, -999.0 is returned for the power results and 0.0 for the frequency results.</p>
2	<p>Returns a series of floating point numbers that represent the frequency-domain spectrum trace for the entire frequency range being measured.</p> <p>In the default settings (SENSE:IM:FREQUENCY:SPAN 20 MHz; SENSE:IM:BANDWIDTH   BWIDTH[:RESOLUTION] 140 kHz), there are 345 numbers.</p>



<b>n</b>	<b>Results Returned</b>
3	<p>Returns 2 scalar values of the measured mode determined by the Auto algorithm.</p> <ol style="list-style-type: none"><li>1. Measurement Mode:<ol style="list-style-type: none"><li>1: Two-tone</li><li>2: Transmit IM</li><li>3: Auto (Two-tone)</li><li>4: Auto (Transmit IM)</li><li>5: Unknown</li></ol></li><li>2. Reference:<ol style="list-style-type: none"><li>1: Lower</li><li>2: Upper</li><li>3: Average</li><li>4: Auto (Lower)</li><li>5: Auto (Upper)</li></ol></li></ol>

## Occupied Bandwidth Measurement

This measures the bandwidth of the carrier signal in the occupied part of the channel. You must be in the PDC, iDEN (E4406A only), cdma2000, W-CDMA, or 1xEV-DO mode to use these commands. Use INSTRument:SElect to set the mode.

The general functionality of CONFigure, FETCh, MEASure, and READ are described at the beginning of this section. See the SENSE:OBW commands for more measurement related commands.

**:CONFigure:OBW**

**:INITiate:OBW**

**:FETCh:OBW[n]?**

**:READ:OBW[n]?**

**:MEASure:OBW[n]?**

History: E4406A:  
 Version A.02.00 or later

Front Panel

Access: **Measure, Occupied BW**

After the measurement is selected, press **Restore Meas Defaults** to restore factory defaults.

### Measurement results available

<b>n</b>	<b>Results Returned</b>
0	Returns unprocessed I/Q trace data, as a data array of trace point values, in volts.
1 (default)	Returns 5 scalar results, in the following order: <ol style="list-style-type: none"> <li>1. Occupied bandwidth - Hz</li> <li>2. Absolute Carrier Power - dBm</li> <li>3. Span - Hz</li> <li>4. Spectrum Trace Points - points</li> <li>5. Res BW - Hz</li> </ol>
2	Returns the frequency-domain spectrum trace (data array) for the entire frequency range being measured.

## Power Statistics CCDF Measurement

For E4406A this is a statistical power measurement of the complementary cumulative distribution function (CCDF). You must be in the Basic, cdma2000, W-CDMA, or 1xEV-DO mode to use these commands. Use INSTRument:SElect to set the mode.

For PSA this is a statistical power measurement of the complementary cumulative distribution function (CCDF). You must be in the cdma2000, W-CDMA, or 1xEV-DO mode to use these commands. Use INSTRument:SElect to set the mode.

The general functionality of CONFigure, FETCh, MEASure, and READ are described at the beginning of this section. See the SENSE:PStat commands for more measurement related commands.

**:CONFigure:PStatistic**

**:INITiate:PStatistic**

**:FETCh:PStatistic [n]?**

**:READ:PStatatistic [n]?**

**:MEASure:PStatatistic [n]?**

History: Version A.03.00 or later, added in Basic A.04.00

Front Panel

Access: **Measure, Power Stat CCDF**

After the measurement is selected, press **Restore Meas Defaults** to restore factory defaults.

### Measurement Results Available

<b>n</b>	<b>Results Returned</b>
0	Returns unprocessed I/Q trace data, as a series of trace point values, in volts. The I values are listed first in each pair, using the 0 through even-indexed values. The Q values are the odd-indexed values,
n=1 (or not specified)	Returns 10 scalar results: <ol style="list-style-type: none"> <li>1. Average input power (in dBm)</li> <li>2. Probability at the average input power level (in %)</li> <li>3. Power level that has 10% of the power</li> <li>4. Power level that has 1% of the power</li> <li>5. Power level that has 0.1% of the power</li> <li>6. Power level that has 0.01% of the power</li> <li>7. Power level that has 0.001% of the power</li> <li>8. Power level that has 0.0001% of the power</li> <li>9. Peak power (in dB)</li> <li>10. Count</li> </ol>

<b>n</b>	<b>Results Returned</b>
2	<p>Returns a series of 5001 floating point numbers (in percent) that represent the current measured power stat trace. This is the probability at particular power levels (average power), in the following order:</p> <ol style="list-style-type: none"> <li>1. Probability at 0.00 dB power</li> <li>2. Probability at 0.01 dB power</li> <li>3. Probability at 0.02 dB power</li> <li>...</li> <li>5000. Probability at 49.99 dB power</li> <li>5001. Probability at 50.00 dB power</li> </ol>
3	<p>Returns a series of 5001 floating point numbers (in percent) that represent the Gaussian trace. This is the probability at particular power levels (average power), in the following order:</p> <ol style="list-style-type: none"> <li>1. Probability at 0.00 dB power</li> <li>2. Probability at 0.01 dB power</li> <li>3. Probability at 0.02 dB power</li> <li>...</li> <li>5000. Probability at 49.99 dB power</li> <li>5001. Probability at 50.00 dB power</li> </ol>
4	<p>Returns a series of 5001 floating point numbers (in percent) that represent the user-definable reference trace. This is the probability at particular power levels (average power), in the following order:</p> <ol style="list-style-type: none"> <li>1. Probability at 0.00 dB power</li> <li>2. Probability at 0.01 dB power</li> <li>3. Probability at 0.02 dB power</li> <li>...</li> <li>5000. Probability at 49.99 dB power</li> <li>5001. Probability at 50.00 dB power</li> </ol>

## Power vs. Time Measurement

For E4406A this measures the average power during the “useful part” of the burst comparing the power ramp to required timing mask. You must be in EDGE, GSM, 1xEV-DO or Service mode to use these commands. Use INSTRument:SElect to set the mode.

For PSA this measures the average power during the “useful part” of the burst comparing the power ramp to required timing mask. You must be in GSM(w/EDGE), or 1xEV-DO mode to use these commands. Use INSTRument:SElect to set the mode.

The general functionality of CONFigure, FETCh, MEASure, and READ are described at the beginning of this section. See the SENSE:PVTime commands for more measurement related commands.

- :CONFigure:PVTime**
- :INITiate:PVTime**
- :FETCh:PVTime [n] ?**
- :READ:PVTime [n] ?**
- :MEASure:PVTime [n] ?**

Front Panel

Access: **Measure, Power vs Time**

After the measurement is selected, press **Restore Meas Defaults** to restore factory defaults.

History: Modified in version A.05.00..

### Measurement Results Available

<b>n</b>	<b>Results Returned</b>
0	Returns unprocessed I/Q trace data, as a series of trace point values, in volts. The I values are listed first in each pair, using the 0 through even-indexed values. The Q values are the odd-indexed values.

n	Results Returned
n=1 (or not specified)	<p>Returns the following 58 scalar results:</p> <ol style="list-style-type: none"> <li>1. Sample time is a floating point number that represents the time between samples when using the trace queries (n=0,2,etc.).</li> <li>2. Power of single burst is the mean power (in dBm) across the useful part of the selected burst in the most recently acquired data, or in the last data acquired at the end of a set of averages. If averaging is on, the power is for the last burst.</li> <li>3. Power averaged is the power (in dBm) of N averaged bursts, if averaging is on. The power is averaged across the useful part of the burst. Average m is a single burst from the acquired trace. If there are multiple bursts in the acquired trace, only one burst is used for average m. This means that N traces are acquired to make the complete average. If averaging is off, the value of power averaged is the same as the power single burst value.</li> <li>4. Number of samples is the number of data points in the captured signal. This number is useful when performing a query on the signal (i.e. when n=0,2,etc.).</li> <li>5. Start point of the useful part of the burst is the index of the data point at the start of the useful part of the burst</li> <li>6. Stop point of the useful part of the burst is the index of the data point at the end of the useful part of the burst</li> <li>7. Index of the data point where <math>T_0</math> occurred.</li> <li>8. Burst width of the useful part of the burst is the width of the burst measured at <math>-3\text{dB}</math> below the mean power in the useful part of the burst.</li> <li>9. Maximum value is the maximum value of the most recently acquired data (in dBm).</li> <li>10. Minimum value is the minimum value of the most recently acquired data (in dBm).</li> <li>11. Burst search threshold is the value (in dBm) of the threshold where a valid burst is identified, after the data has been acquired.</li> <li>12. IQ point delta is the number of data points offset that are internally applied to the useful data in traces n=2,3,4. You must apply this correction value to find the actual location of the Start, Stop, or <math>T_0</math> values.</li> </ol> <p>(Continued Next Page)</p>

<b>n</b>	<b>Results Returned</b>
<p>n=1 (or not specified)</p> <p>(Continued)</p>	<p>13. Sample time is a floating point number that represents the time between samples when using the trace queries (where n = 0, 2, etc.).</p> <p>14. Power of single burst is the mean power (in dBm) across the useful part of the selected burst in the most recently acquired data, or in the last data acquired at the end of a set of averages. If averaging is on, the power is for the last burst.</p> <p>15. Power averaged is the power (in dBm) of N averaged bursts, if averaging is on. The power is averaged across the useful part of the burst. Average m is a single burst from the acquired trace. If there are multiple bursts in the acquired trace, only one burst is used for average m. This means that N traces are acquired to make the complete average. If averaging is off, the value of power averaged is the same as the power single burst value.</p> <p>16. Number of samples (N) is the number of data points in the captured signal. This number is useful when performing a query on the signal (i.e. when n = 0, 2, etc.).</p> <p>17. Start point of the useful part of the burst is the index of the data point at the start of the useful part of the burst</p> <p>18. Stop point of the useful part of the burst is the index of the data point at the end of the useful part of the burst</p> <p>19. Index of the data point where T<sub>0</sub> occurred.</p> <p>20. Burst width of the useful part of the burst is the width of the burst measured at -3dB below the mean power in the useful part of the burst.</p> <p>21. Maximum value is the maximum value of the most recently acquired data (in dBm).</p> <p>22. Minimum value is the minimum value of the most recently acquired data (in dBm).</p> <p>23. Burst search threshold is the value (in dBm) of the threshold where a valid burst is identified, after the data has been acquired.</p> <p>24. Averaged number (N) is used to average the measurement results.</p> <p>25. First position in index to exceed the limit (N).</p> <p>26. Reserved for future use, returns -999.0.</p> <p>27. Reserved for future use, returns -999.0.</p> <p>28. Reserved for future use, returns -999.0.</p> <p>29. Absolute power in the region A (dBm)</p> <p>30. Absolute power in the region B (dBm)</p> <p>31. Absolute power in the region C (dBm)</p> <p>32. Absolute power in the region D (dBm)</p> <p>33. Absolute power in the region E (dBm)</p> <p>34. Relative power in the region A (dB)</p> <p>35. Relative power in the region B (dB)</p> <p>36. Relative power in the region C (dB)</p> <p>37. Relative power in the region D (dB)</p> <p>(Continued Next Page)</p>

<b>n</b>	<b>Results Returned</b>
n=1 (or not specified) (Continued)	38. Relative power in the region E (dB) 39. Maximum absolute power in the region A (dBm) 40. Maximum absolute power in the region B (dBm) 41. Maximum absolute power in the region C (dBm) 42. Maximum absolute power in the region D (dBm) 43. Maximum absolute power in the region E (dBm) 44. Maximum relative power in the region A (dB) 45. Maximum relative power in the region B (dB) 46. Maximum relative power in the region C (dB) 47. Maximum relative power in the region D (dB) 48. Maximum relative power in the region E (dB) 49. Minimum absolute power in the region A (dBm) 50. Minimum absolute power in the region B (dBm) 51. Minimum absolute power in the region C (dBm) 52. Minimum absolute power in the region D (dBm) 53. Minimum absolute power in the region E (dBm) 54. Minimum relative power in the region A (dB) 55. Minimum relative power in the region B (dB) 56. Minimum relative power in the region C (dB) 57. Minimum relative power in the region D (dB) 58. Minimum relative power in the region E (dB)
2	Returns trace point values of the entire captured I/Q trace data. These data points are floating point numbers representing the power of the signal (in dBm). There are N data points, where N is the number of samples. The period between the samples is defined by the sample time.
3	Returns data points representing the upper mask (in dBm).
4	Returns data points representing the lower mask (in dBm).



## Modulation Accuracy (Rho) Measurement

This measures the modulation accuracy of the transmitter by checking the magnitude and phase error and the EVM (error vector magnitude). You must be in the cdmaOne, cdma2000, W-CDMA, or 1xEV-DO mode to use these commands. Use INSTRument:SElect to set the mode.

For 1xEV-DO: these commands will measure modulation accuracy on network access equipment (base transmitter stations). Use MEAS:TRHO to measure terminal transmitter modulation accuracy, after selecting mobile stations using SENSE:RADio:DEVIce MS.

The general functionality of CONFigure, FETCh, MEASure, and READ are described at the beginning of this section. See the SENSE:RHO commands for more measurement related commands.

- :CONFigure:RHO**
- :INITiate:RHO**
- :FETCh:RHO [n] ?**
- :READ:RHO [n] ?**
- :MEASure:RHO [n] ?**

Front Panel

Access: **Measure, Mod Accuracy (Rho)** for cdmaOne

**Measure, Mod Accuracy (Composite Rho)** for cdma2000, 1xEV-DO, or W-CDMA (3GPP)

After the measurement is selected, press **Restore Meas Defaults** to restore factory defaults.

### Measurement Results Available

<b>n</b>	<b>Results Returned</b>
<p>n=1 (or not specified)</p> <p>For base stations: SENS:RAD:DEV BTS</p> <p>For meas type: CALC:RHO:TYPE DATA   MAC   PILot   PREamble</p>	<p>Returns up to the following 31 comma-separated scalar results, in the following order:</p> <p>Returns ONLY the following 9 comma-separated scalar results, in the following order, for base transmitter station measurements when the type is NOT set to ALL:</p> <ol style="list-style-type: none"> <li>1. RMS EVM – a floating point number (in percent) of EVM over the entire measurement area.</li> <li>2. Peak EVM error – a floating point number (in percent) of peak EVM in the measurement area.</li> <li>3. Magnitude error – a floating point number (in percent) of average magnitude error over the entire measurement area.</li> </ol> <p>(Continued Next Page)</p>

<b>n</b>	<b>Results Returned</b>
<p>n=1 (or not specified)            (CONTINUED)</p> <p>For base stations:            SENS:RAD:DEV            BTS</p> <p>For meas type ALL:            CALC:RHO:TYPE            ALL</p>	<ol style="list-style-type: none"> <li>4. Phase error – a floating point number (in degree) of average phase error over the entire measurement area.</li> <li>5. I/Q Origin Offset – a floating point number (in dB) of the I and Q error (magnitude squared) offset from the origin.</li> <li>6. Frequency error – a floating point number (in Hz) of the frequency error in the measured signal.</li> <li>7. Rho – a floating point number of Rho.</li> <li>8. Number of active channels.</li> <li>9. Time offset is the time from the trigger to the PN offset – a floating point number (in micro seconds) of PN offset from the trigger point.</li> </ol> <p style="text-align: center;">Rho Overall-1 and Rho Overall-2 specified in 3GPP2 TSG-C4.1 Recommended Minimum Performance Standard for cdma2000 High Rate Data Packet Access Network, 11.4.2 Waveform Quality Measurement section.</p> <ol style="list-style-type: none"> <li>10. RMS EVM (Overall-1) – a floating point number (in percent) of EVM over the entire measurement area.</li> <li>11. Peak EVM error (Overall-1) – a floating point number (in percent) of peak EVM in the measurement area.</li> <li>12. Magnitude error (Overall-1) – a floating point number (in percent) of average magnitude error over the entire measurement area.</li> <li>13. Phase error (Overall-1) – a floating point number (in degree) of average phase error over the entire measurement area.</li> <li>14. I/Q Origin Offset (Overall-1) – a floating point number (in dB) of the I and Q error (magnitude squared) offset from the origin.</li> <li>15. Frequency error (Overall-1) – a floating point number (in Hz) of the frequency error in the measured signal.</li> <li>16. Rho (Overall-1) – a floating point number of Rho.</li> <li>17. RMS EVM (Overall-2) – a floating point number (in percent) of EVM over the entire measurement area.</li> <li>18. Peak EVM error (Overall-2) – a floating point number (in percent) of peak EVM in the measurement area.</li> <li>19. Magnitude error (Overall-2) – a floating point number (in percent) of average magnitude error over the entire measurement area.</li> <li>20. Phase error (Overall-2) – a floating point number (in degree) of average phase error over the entire measurement area.</li> <li>21. I/Q Origin Offset (Overall-2) – a floating point number (in dB) of the I and Q error (magnitude squared) offset from the origin.</li> <li>22. Frequency error (Overall-2) – a floating point number (in Hz) of the frequency error in the measured signal.</li> <li>23. Rho (Overall-2) – a floating point number of Rho.</li> <li>24. Number of active channels in Pilot</li> <li>25. Number of active channels in Mac</li> <li>26. Number of active channels in Data</li> </ol> <p style="text-align: center;">(Continued Next Page)</p>

n	Results Returned
<p>n=1 (or not specified)</p> <p>(CONTINUED)</p> <p>For base stations: SENS:RAD:DEV BTS</p> <p>For meas type ALL: CALC:RHO:TYPE ALL</p>	<p>27. Preamble Length- a floating point number (in chips)</p> <p>28. MAC Index</p> <p>29. Max MAC Inactive channel Power – a floating point number (in dB) of Maximum MAC Inactive Channel Power.</p> <p>30. Max Data Active Channel Power – a floating point number (in dB) of Maximum Data Active Channel Power</p> <p>31. Min Data Active Channel Power – a floating point number (in dB) of Minimum Data Active Channel Power</p>
<p>2</p>	<p>Returns series of floating point numbers (in percent) that represent each chip in the EVM trace.</p> <p>This traces is available when the Measurement Channel Type Selection is Pilot, MAC or Data (CALCulate:RHO:TYPE = PILOt   MAC   DATA) In all cases, returns one full slot data points, but only portion of EVM computation is performed are valid. All other portion is 0.0</p>
<p>3</p>	<p>Magnitude error trace – returns series of floating point numbers (in percent) that represent each sample in the magnitude error trace. The first number is the symbol 0 decision point. There are X points per symbol (X = points/chip). Therefore, the decision points are at 0, 1 × X, 2 × X, 3 × X . . . .</p> <p>For 1xEV-DO: this traces is available when the Measurement Channel Type Selection is Pilot, MAC or Data (CALCulate:RHO:TYPE = PILOt   MAC   DATA) In all cases, returns one full slot data points, but only portion of EVM computation is performed are valid. All other portion is 0.0</p>
<p>4</p>	<p>Phase error trace – returns series of floating point numbers (in degrees) that represent each sample in the phase error trace. There are X points per symbol (X = points/ chip). Therefore, the decision points are at 0, 1 × X, 2 × X, 3 × X . . . .</p> <p>For 1xEV-DO: this traces is available when the Measurement Channel Type Selection is Pilot, MAC or Data (CALCulate:RHO:TYPE = PILOt   MAC   DATA) In all cases, returns one full slot data points, but only portion of EVM computation is performed are valid. All other portion is 0.0</p>

n	Results Returned
5	<p>Corrected measured trace – returns series of floating point numbers that alternately represent I and Q pairs of the corrected measured trace. The magnitude of each I and Q pair are normalized to 1.0. The first number is the in-phase (I) sample of symbol 0 decision point and the second is the quadrature-phase (Q) sample of symbol 0 decision point. There are X points per symbol (X = points/chip), so the series of numbers is:</p> <p>1st number = I of the symbol 0 decision point            2nd number = Q of the symbol 0 decision point</p> <p>. . .  <math>(2 \times X) + 1</math>, number = I of the symbol 1 decision point  <math>(2 \times X) + 2</math>, number = Q of the symbol 1 decision point</p> <p>. . .  <math>(2 \times X) \times N</math>th + 1 number = I of the symbol N decision point  <math>(2 \times X) \times N</math>th + 2 number = Q of the symbol N decision point</p> <p>For 1xEV-DO: this traces is available when the Measurement Channel Type Selection is Pilot, MAC or Data (CALCulate:RHO:TYPE = PILOT   MAC   DATA) In all cases, returns one full slot data points, but only portion of EVM computation is performed are valid. All other portion is 0.0</p>
6	<p>The same as n=2. (Overall-1)</p> <p>This trace is available when the Measurement Channel Type Selection is All            (CALCulate:RHO:TYPE = ALL)</p> <p>(Rho Overall-1 and Rho Overall-2 as specified in 3GPP2 TSG-C4.1 Recommended Minimum Performance Standard for cdma2000 High Rate Data Packet Access Network, 11.4.2 Waveform Quality Measurement section.)</p> <p>n=6, 7, 8, 9 are for Overall-1 data trace            n=10, 11, 12, 13 are for Overall-2 data trace</p> <p>In all cases, returns one full slot data points, but only portion of EVM computation is performed are valid. All other portion is 0.0</p>
7	<p>The same as n=3. (Overall-1)</p> <p>This trace is available when the Measurement Channel Type Selection is All            (CALCulate:RHO:TYPE = ALL)</p> <p>(Rho Overall-1 and Rho Overall-2 as specified in 3GPP2 TSG-C4.1 Recommended Minimum Performance Standard for cdma2000 High Rate Data Packet Access Network, 11.4.2 Waveform Quality Measurement section.)</p> <p>n=6, 7, 8, 9 are for Overall-1 data trace            n=10, 11, 12, 13 are for Overall-2 data trace</p> <p>In all cases, returns one full slot data points, but only portion of EVM computation is performed are valid. All other portion is 0.0</p>

<b>n</b>	<b>Results Returned</b>
8	<p>The same as n=4. (Overall-1)</p> <p>This trace is available when the Measurement Channel Type Selection is All            (CALCulate:RHO:TYPE = ALL)</p> <p>(Rho Overall-1 and Rho Overall-2 as specified in 3GPP2 TSG-C4.1 Recommended Minimum Performance Standard for cdma2000 High Rate Data Packet Access Network, 11.4.2 Waveform Quality Measurement section.)</p> <p>n=6, 7, 8, 9 are for Overall-1 data trace            n=10, 11, 12, 13 are for Overall-2 data trace</p> <p>In all cases, returns one full slot data points, but only portion of EVM computation is performed are valid. All other portion is 0.0</p>
9	<p>The same as n=5. (Overall-1)</p> <p>This trace is available when the Measurement Channel Type Selection is All            (CALCulate:RHO:TYPE = ALL)</p> <p>(Rho Overall-1 and Rho Overall-2 as specified in 3GPP2 TSG-C4.1 Recommended Minimum Performance Standard for cdma2000 High Rate Data Packet Access Network, 11.4.2 Waveform Quality Measurement section.)</p> <p>n=6, 7, 8, 9 are for Overall-1 data trace            n=10, 11, 12, 13 are for Overall-2 data trace</p> <p>In all cases, returns one full slot data points, but only portion of EVM computation is performed are valid. All other portion is 0.0</p>
10	<p>The same as n=2. (Overall-2)</p> <p>This trace is available when the Measurement Channel Type Selection is All            (CALCulate:RHO:TYPE = ALL)</p> <p>(Rho Overall-1 and Rho Overall-2 as specified in 3GPP2 TSG-C4.1 Recommended Minimum Performance Standard for cdma2000 High Rate Data Packet Access Network, 11.4.2 Waveform Quality Measurement section.)</p> <p>n=6, 7, 8, 9 are for Overall-1 data trace            n=10, 11, 12, 13 are for Overall-2 data trace</p> <p>In all cases, returns one full slot data points, but only portion of EVM computation is performed are valid. All other portion is 0.0</p>

<b>n</b>	<b>Results Returned</b>
11	<p>The same as n=3. (Overall-2)</p> <p>This trace is available when the Measurement Channel Type Selection is All</p> <p>(CALCulate:RHO:TYPE = ALL)</p> <p>(Rho Overall-1 and Rho Overall-2 as specified in 3GPP2 TSG-C4.1 Recommended Minimum Performance Standard for cdma2000 High Rate Data Packet Access Network, 11.4.2 Waveform Quality Measurement section.)</p> <p>n=6, 7, 8, 9 are for Overall-1 data trace</p> <p>n=10, 11, 12, 13 are for Overall-2 data trace</p> <p>In all cases, returns one full slot data points, but only portion of EVM computation is performed are valid. All other portion is 0.0</p>
12	<p>The same as n=4. (Overall-2)</p> <p>This trace is available when the Measurement Channel Type Selection is All</p> <p>(CALCulate:RHO:TYPE = ALL)</p> <p>(Rho Overall-1 and Rho Overall-2 as specified in 3GPP2 TSG-C4.1 Recommended Minimum Performance Standard for cdma2000 High Rate Data Packet Access Network, 11.4.2 Waveform Quality Measurement section.)</p> <p>n=6, 7, 8, 9 are for Overall-1 data trace</p> <p>n=10, 11, 12, 13 are for Overall-2 data trace</p> <p>In all cases, returns one full slot data points, but only portion of EVM computation is performed are valid. All other portion is 0.0</p>
13	<p>The same as n=5. (Overall-2)</p> <p>This trace is available when the Measurement Channel Type Selection is All</p> <p>(CALCulate:RHO:TYPE = ALL)</p> <p>(Rho Overall-1 and Rho Overall-2 as specified in 3GPP2 TSG-C4.1 Recommended Minimum Performance Standard for cdma2000 High Rate Data Packet Access Network, 11.4.2 Waveform Quality Measurement section.)</p> <p>n=6, 7, 8, 9 are for Overall-1 data trace</p> <p>n=10, 11, 12, 13 are for Overall-2 data trace</p> <p>In all cases, returns one full slot data points, but only portion of EVM computation is performed are valid. All other portion is 0.0</p>
14	Returns descrambled Trace data.

<b>n</b>	<b>Results Returned</b>
15	<p>Returns 10 comma-separated scalar values of the pass/fail (0.0=passed, or 1.0=failed) results determined by testing the EVM, Peak EVM:</p> <ol style="list-style-type: none"> <li>1. Test result of EVM</li> <li>2. Test result of Peak EVM</li> <li>3. Test result of Rho</li> <li>4. Test result of Frequency Error</li> </ol> <p>Following Timing and Phase results are valid only Multichannel Estimator is On and existence of multiple codes. When the measurement is not valid, the results are 0.0</p> <ol style="list-style-type: none"> <li>5. Test result of Timing</li> <li>6. Test result of Phase</li> </ol> <p>Following Pilot Offset result is valid only external trigger is selected. When the measurement is not valid, the result is 0.0</p> <ol style="list-style-type: none"> <li>7. Test result of Pilot Offset</li> </ol> <p>Following three results are valid exclusively. When the measurement is not valid, the result is 0.0</p> <ol style="list-style-type: none"> <li>8. Test result of Max MAC Inactive Channel Power</li> <li>9. Test result of Max Data Active Channel Power</li> <li>10. Test result of Min Data Active Channel Power</li> </ol>

## Spurious Emissions Measurement

This measures spurious emissions levels up to five pairs of offset/region frequencies and relates them to the carrier power. You must be in the cdma2000, W-CDMA or 1xEV-DO mode to use these commands. Use INSTRument:SElect to set the mode. For 1xEV-DO mode, this command will return spurious emissions measurements or adjacent channel power measurements, depending on which setting is selected using SENSE:SEMask:SEGment:TYPE ACPr | SEMask.

The general functionality of CONFigure, FETCh, MEASure, and READ are described at the beginning of this section. See the SENSE:SEMask commands for more measurement related commands.

**:CONFigure:SEMask**

**:INITiate:SEMask**

**:FETCh:SEMask [n] ?**

**:READ:SEMask [n] ?**

**:MEASure:SEMask [n] ?**

Front Panel

Access: **Measure, Spectrum Emission Mask**

After the measurement is selected, press **Restore Meas Defaults** to restore factory defaults.

### Measurement Results Available

Measurement Type	n	Results Returned
	0	Returns unprocessed I/Q trace data, as a series of trace point values, in volts.



<b>Measurement Type</b>	<b>n</b>	<b>Results Returned</b>
Total power reference	n=1 (or not specified)	<p>Returns 60 scalar results, in the following order:</p> <ol style="list-style-type: none"> <li>1. Reserved for future use, returns -999.0</li> <li>2. Absolute power at the center frequency (reference) area (dBm)</li> <li>3. Reserved for future use, returns -999.0</li> <li>4. Reserved for future use, returns -999.0</li> <li>5. Peak frequency in the center frequency (reference) area (Hz)</li> <li>6. Reserved for future use, returns -999.0</li> <li>7. Reserved for future use, returns -999.0</li> <li>8. Reserved for future use, returns -999.0</li> <li>9. Reserved for future use, returns -999.0</li> <li>10. Reserved for future use, returns -999.0</li> <li>11. Relative power on the negative offset A (dBc)</li> <li>12. Absolute power on the negative offset A (dBm)</li> <li>13. Relative peak power on the negative offset A (dBc)</li> <li>14. Absolute peak power on the negative offset A (dBm)</li> <li>15. Peak frequency in the negative offset A (Hz)</li> <li>16. Relative power on the positive offset A (dBc)</li> <li>17. Absolute power on the positive offset A (dBm)</li> <li>18. Relative peak power on the positive offset A (dBc)</li> <li>19. Absolute peak power on the positive offset A (dBm)</li> <li>20. Peak frequency in the positive offset A (Hz)</li> <li>21. Relative power on the negative offset B (dBc)</li> </ol> <p style="text-align: center;">. . .</p> <ol style="list-style-type: none"> <li>59. Absolute peak power on the positive offset E (dBm)</li> <li>60. Peak frequency in the positive offset E (Hz)</li> </ol> <p>When [:SENSE]:SEMask:SEGMENT is set to REGION, the positive offsets are not available and return -999.0.</p>

Measurement Type	n	Results Returned
Power spectral density reference	n=1 (or not specified)	<p>Returns 60 scalar results, in the following order:</p> <ol style="list-style-type: none"> <li>1. Reserved for future use, returns -999.0</li> <li>2. Absolute power at the center frequency (reference) area (dBm)</li> <li>3. Reserved for future use, returns -999.0</li> <li>4. Reserved for future use, returns -999.0</li> <li>5. Peak frequency in the center frequency (reference) area (Hz)</li> <li>6. Reserved for future use, returns -999.0</li> <li>7. Reserved for future use, returns -999.0</li> <li>8. Reserved for future use, returns -999.0</li> <li>9. Reserved for future use, returns -999.0</li> <li>10. Reserved for future use, returns -999.0</li> <li>11. Relative power on the negative offset A (dB)</li> <li>12. Absolute power on the negative offset A (dBm/Hz)</li> <li>13. Relative peak power on the negative offset A (dB)</li> <li>14. Absolute peak power on the negative offset A (dBm/Hz)</li> <li>15. Peak frequency in the negative offset A (Hz)</li> <li>16. Relative power on the positive offset A (dB)</li> <li>17. Absolute power on the positive offset A (dBm/Hz)</li> <li>18. Relative peak power on the positive offset A (dB)</li> <li>19. Absolute peak power on the positive offset A (dBm/Hz)</li> <li>20. Peak frequency in the positive offset A (Hz)</li> <li>21. Relative power on the negative offset B (dB)</li> </ol> <p style="text-align: center;">. . .</p> <ol style="list-style-type: none"> <li>59. Absolute peak power on the positive offset E (dBm)</li> <li>60. Peak frequency in the positive offset E (Hz)</li> </ol> <p>When [:SENSE]:SEMask:SEGMENT is set to REGION, the positive offsets are not available and return -999.0.</p>
	2	Returns the displayed frequency domain spectrum trace data separated by comma. The number of data is 2001 when DISPLAY:SEMask:VIEW is set to ALL.
	3	Returns the displayed frequency domain absolute limit trace data separated by comma. The number of data is 2001 when DISPLAY:SEMask:VIEW is set to ALL.
	4	Returns the displayed frequency domain relative limit trace data separated by comma. The number of data is 2001 when DISPLAY:SEMask:VIEW is set to ALL.

<b>Measurement Type</b>	<b>n</b>	<b>Results Returned</b>
Total power reference	5	<p>Returns 12 scalar values (in dBm) of the absolute power of the segment frequencies:</p> <ol style="list-style-type: none"> <li>1. Reserved for future use, returns –999.0</li> <li>2. Reserved for future use, returns –999.0</li> <li>3. Negative offset frequency (A) or region (A)</li> <li>4. Positive offset frequency (A)</li> </ol> <p style="text-align: center;">. . .</p> <ol style="list-style-type: none"> <li>11. Negative offset frequency (E) or region (E)</li> <li>12. Positive offset frequency (E)</li> </ol> <p>When [:SENSE]:SEMask:SEGMENT is set to REGION, the positive offsets are not available and return –999.0.</p>
Power spectral density reference	5	<p>Returns 12 scalar values (in dBm/Hz) of the absolute power of the segment frequencies:</p> <ol style="list-style-type: none"> <li>1. Reserved for future use, returns –999.0</li> <li>2. Reserved for future use, returns –999.0</li> <li>3. Negative offset frequency (A) or region (A)</li> <li>4. Positive offset frequency (A)</li> </ol> <p style="text-align: center;">. . .</p> <ol style="list-style-type: none"> <li>11. Negative offset frequency (E) or region (E)</li> <li>12. Positive offset frequency (E)</li> </ol> <p>When [:SENSE]:SEMask:SEGMENT is set to REGION, the positive offsets are not available and return –999.0.</p>
Total power reference	6	<p>Returns 12 scalar values (in dBc) of the power relative to the carrier at the segment frequencies:</p> <ol style="list-style-type: none"> <li>1. Reserved for future use, returns –999.0</li> <li>2. Reserved for future use, returns –999.0</li> <li>3. Negative offset frequency (A) or region (A)</li> <li>4. Positive offset frequency (A)</li> </ol> <p style="text-align: center;">. . .</p> <ol style="list-style-type: none"> <li>11. Negative offset frequency (E) or region (E)</li> <li>12. Positive offset frequency (E)</li> </ol> <p>When [:SENSE]:SEMask:SEGMENT is set to REGION, the positive offsets are not available and return –999.0.</p>

Measurement Type	n	Results Returned
Power spectral density reference	6	<p>Returns 12 scalar values (in dBc) of the power relative to the carrier at the segment frequencies:</p> <ol style="list-style-type: none"> <li>1. Reserved for future use, returns –999.0</li> <li>2. Reserved for future use, returns –999.0</li> <li>3. Negative offset frequency (A) or region (A)</li> <li>4. Positive offset frequency (A)</li> <li>...</li> <li>11. Negative offset frequency (E) or region (E)</li> <li>12. Positive offset frequency (E)</li> </ol> <p>When [:SENSE]:SEMask:SEGMENT is set to REGION, the positive offsets are not available and return –999.0.</p>
	7	<p>Returns 12 pass/fail test results (0 = passed, or 1 = failed) determined by testing the absolute power of the segment frequencies:</p> <ol style="list-style-type: none"> <li>1. Reserved for future use, returns –999.0</li> <li>2. Reserved for future use, returns –999.0</li> <li>3. Negative offset frequency (A) or region (A)</li> <li>4. Positive offset frequency (A)</li> <li>...</li> <li>11. Negative offset frequency (E) or region (E)</li> <li>12. Positive offset frequency (E)</li> </ol> <p>When [:SENSE]:SEMask:SEGMENT is set to REGION, the positive offsets are not available and return –999.0.</p>
	8	<p>Returns 12 scalar values of the pass/fail (0=passed, or 1=failed) results determined by testing the power relative to the segment frequencies:</p> <ol style="list-style-type: none"> <li>1. Reserved for future use, returns –999.0</li> <li>2. Reserved for future use, returns –999.0</li> <li>3. Negative offset frequency (A) or region (A)</li> <li>4. Positive offset frequency (A)</li> <li>...</li> <li>11. Negative offset frequency (E) or region (E)</li> <li>12. Positive offset frequency (E)</li> </ol> <p>When [:SENSE]:SEMask:SEGMENT is set to REGION, the positive offsets are not available and return –999.0.</p>

Measurement Type	n	Results Returned
	9	<p>Returns 12 scalar values of frequency (in Hz) that have peak power in each offset/region:</p> <ol style="list-style-type: none"> <li>1. Reserved for future use, returns –999.0</li> <li>2. Reserved for future use, returns –999.0</li> <li>3. Negative offset frequency (A) or region (A)</li> <li>4. Positive offset frequency (A)</li> </ol> <p style="text-align: center;">. . .</p> <ol style="list-style-type: none"> <li>11. Negative offset frequency (E) or region (E)</li> <li>12. Positive offset frequency (E)</li> </ol> <p>When [:SENSE]:SEMAsk:SEGMENT is set to REGION, the positive offsets are not available and return –999.0.</p>
	10	<p>Returns 12 scalar values (in dBm) of the absolute peak power of the segment frequencies:</p> <ol style="list-style-type: none"> <li>1. Reserved for future use, returns –999.0</li> <li>2. Reserved for future use, returns –999.0</li> <li>3. Negative offset frequency (A) or region (A)</li> <li>4. Positive offset frequency (A)</li> </ol> <p style="text-align: center;">. . .</p> <ol style="list-style-type: none"> <li>11. Negative offset frequency (E) or region (E)</li> <li>12. Positive offset frequency (E)</li> </ol> <p>When [:SENSE]:SEMAsk:SEGMENT is set to REGION, the positive offsets are not available and return –999.0.</p>
	11	<p>Returns 12 scalar values (in dBc) of the peak power relative to the carrier at the segment frequencies:</p> <ol style="list-style-type: none"> <li>1. Reserved for future use, returns –999.0</li> <li>2. Reserved for future use, returns –999.0</li> <li>3. Negative offset frequency (A) or region (A)</li> <li>4. Positive offset frequency (A)</li> </ol> <p style="text-align: center;">. . .</p> <ol style="list-style-type: none"> <li>11. Negative offset frequency (E) or region (E)</li> <li>12. Positive offset frequency (E)</li> </ol> <p>When [:SENSE]:SEMAsk:SEGMENT is set to REGION, the positive offsets are not available and return –999.0.</p>

## Spectrum (Frequency Domain) Measurement

For E4406A this measures the amplitude of your input signal with respect to the frequency. It provides spectrum analysis capability using FFT (fast Fourier transform) measurement techniques. You must select the appropriate mode using INSTRument:SElect, to use these commands.

For PSA this measures the amplitude of your input signal with respect to the frequency. It provides spectrum analysis capability using FFT (fast Fourier transform) measurement techniques. You must be in the Basic, cdmaOne, cdma2000, 1xEV-DO, W-CDMA, GSM (w/EDGE), NADC, or PDC mode to use these commands. Use INSTRument:SElect, to select the mode.

The general functionality of CONFigure, FETCh, MEASure, and READ are described at the beginning of this section. See the SENSE:SPECTrum commands for more measurement related commands.

```
:CONFigure:SPECTrum  
:INITiate:SPECTrum  
:FETCh:SPECTrum[n]?  
:READ:SPECTrum[n]?  
:MEASure:SPECTrum[n]?
```

Front Panel

Access: **Measure, Spectrum (Freq Domain)**

After the measurement is selected, press **Restore Meas Defaults** to restore factory defaults.

### Measurement Results Available

n	Results Returned
0	Returns unprocessed I/Q trace data, as a series of trace point values, in volts. The I values are listed first in each pair, using the 0 through even-indexed values. The Q values are the odd-indexed values.

n	Results Returned
n=1 (or not specified)	<p>Returns the following 11 scalar results:</p> <ol style="list-style-type: none"> <li>1. FFT peak is the FFT peak amplitude.</li> <li>2. FFT frequency is the FFT frequency of the peak amplitude.</li> <li>3. FFT points is the Number of points in the FFT spectrum.</li> <li>4. First FFT frequency is the frequency of the first FFT point of the spectrum.</li> <li>5. FFT spacing is the frequency spacing between the FFT points of the spectrum.</li> <li>6. Time domain points is the number of points in the time domain trace used for the FFT. The number of points doubles if the data is complex instead of real. See the time domain scaler description below.</li> <li>7. First time point is the time of the first time domain point, where time zero is the trigger event.</li> <li>8. Time spacing is the time spacing between the time domain points. The time spacing value doubles if the data is complex instead of real. See the time domain scaler description below.</li> <li>9. Time domain returns a 1 if time domain is complex (I/Q) and complex data will be returned. It returns a 0 if the data is real. (raw ADC samples) When this value is 1 rather than 0 (complex vs. real data), the time domain points and the time spacing scalers both increase by a factor of two.</li> <li>10. Scan time is the total scan time of the time domain trace used for the FFT. The total scan time = (time spacing) X (time domain points – 1)</li> <li>11. Current average count is the current number of data measurements that have already been combined, in the averaging calculation.</li> </ol>
2, <b>Service</b> mode only	Returns the trace data of the log-magnitude versus time. (That is, the RF envelope.)
3	Returns the I and Q trace data. It is represented by I and Q pairs (in volts) versus time.
4	Returns spectrum trace data. That is, the trace of log-magnitude versus frequency. (The trace is computed using a FFT.)
5, <b>Service</b> mode only	Returns the averaged trace data of log-magnitude versus time. (That is, the RF envelope.)
6	Not used.
7	Returns the averaged spectrum trace data. That is, the trace of the averaged log-magnitude versus frequency.
8	Not used.
9, <b>Service</b> mode only	Returns a trace containing the shape of the FFT window.

<b>n</b>	<b>Results Returned</b>
10, <b>Service</b> mode only	Returns trace data of the phase of the FFT versus frequency.
11,	(for E4406A VSA Only) Returns linear spectrum trace data values in Volts RMS.
12,	(for E4406A VSA Only) Returns averaged linear spectrum trace data values in Volts RMS.



## Terminal Code Domain Measurement

This measures the power levels of the spread channels in RF channel(s). You must be in the 1xEV-DO mode to use these commands. Use INSTRument:SElect to set the mode.

This measurement is used only for mobile stations (access terminals). When measuring base stations (network access) use Code Domain Power Measurements (MEAS:CDPower) and set SENSE:RADio:DEvice to BTS.

The general functionality of CONFigure, FETCh, MEASure, and READ are described at the beginning of this section. See the SENSE:CDPower commands for more measurement related commands.

```
:CONFigure:TCDPower
:INITiate:TCDPower
:FETCh:TCDPower [n] ?
:READ:TCDPower [n] ?
:MEASure:TCDPower [n] ?
```

Index: n	Result Returned
0	Returns unprocessed I/Q trace data as a series of comma-separated trace points, in volts.

1	<p>Returns following 22 comma-separated scalar results, in the following order:</p> <ol style="list-style-type: none"> <li>1. RMS Symbol EVM – a floating point number (in percent) of EVM over the entire measurement area.</li> <li>2. Peak Symbol EVM error – a floating point number (in percent) of peak EVM in the measurement area.</li> <li>3. Symbol Magnitude error – a floating point number (in percent) of average magnitude error over the entire measurement area.</li> <li>4. Symbol Phase error – a floating point number (in degree) of average phase error over the entire measurement area.</li> <li>5. Total Power – a floating point number (in dBm) of total RF power over the meas interval.</li> </ol> <p>The following 16 results are computed in CDP computation. The unit indicated (dBm/dB) is dBm or dB depending on the selection of :CALCulate:TCDPower:TYPE. When the selection is Relative, the power is relative to Total Power.</p> <ol style="list-style-type: none"> <li>6. Average Power – a floating point number of the entire slot for the selected code averaged over the meas interval.</li> <li>7. Total Active Power – a floating point number (in dBm/dB) of sum of active power.</li> <li>8. Pilot power – a floating point number (in dBm/dB) of average power of Pilot code.</li> <li>9. (Reserved) – (always –999.0)</li> <li>10. (Reserved) – (always –999.0)</li> <li>11. (Reserved) – (always –999.0)</li> <li>12. (Reserved) – (always –999.0)</li> <li>13. (Reserved) – (always –999.0)</li> <li>14. Number of Active Channels</li> <li>15. I channel Average Active Power – floating number (in dBm/dB)</li> <li>16. I channel Max Inactive Power – floating number (in dBm/dB)</li> <li>17. Q channel Average Active Power – floating number (in dBm/dB)</li> <li>18. Q channel Max Inactive Power – floating number (in dBm/dB)</li> <li>19. (Reserved) – (always –999.0)</li> <li>20. Channel CDE – floating number. The absolute or relative (relative to Total Power) CDE in the entire slot, for the selected code, averaged over the measurement period (Meas Interval and Meas Offset)</li> </ol> <p>(Continued Next Page)</p>
---	---

<p>1 (Cont'd)</p>	<p>21. First Slot Number - It is an integer number of first slot in Capture Interval.</p> <p>22. Modulation Scheme – It is an integer number to represent the modulation scheme for the specified channel and measurement time period.</p> <p>The modulation scheme represented by the numbers are:</p> <p>0 = BPSK  1 = QPSK  2 = 8PSK</p>
<p>2</p>	<p>Returns series of floating point numbers (in dB or dBm depend on the measurement type) that represent all code domain powers.</p> <p>When I/Q Combined Power Bar is set to ON, total is 16 for Subtype 0/1, 32 for Subtype 2. If the active channel occupies more than the max spreading factor (16 for Subtype 0/1, 32 for Subtype 2) the power is duplicated.</p> <p>1st number = 1st code power over the slot  2nd number = 2nd code power over the slot  ...  Nth number = Nth code power over the slot</p> <p>When I/Q combined Power Bar is set to OFF, code domain power results are returned alternatively. Total is 32 IQ pairs for Subtype 0/1, 64 IQ pairs for Subtype 2. If the active channel occupies more than max spreading factor (16 for Subtype 0/1, 32 for Subtype 2), the power is duplicated.</p> <p>1st number = 1st In Phase code power over the slot.  2nd number = 1st Quad Phase code power over the slot.  ...  (2*N-1)th number = Nth In Phase code power over the slot  (2*N)th number = Nth Quad Phase code power over the slot</p>

3	<p>Returns series of floating point numbers (in symbol rate) that represent all code domain symbol rate.</p> <p>I and Q results are returned alternatively. Total 32 IQ pairs. If the active channel occupies more than max spreading factor (16), the power is duplicated. times</p> <p>1st number = 1st In Phase code symbol rate over the slot.          2nd number = 1st Quad Phase code symbol rate over the slot.          ...          (2*N-1)th number = Nth In Phase code symbol rate over the slot          (2*N)th number = Nth Quad Phase code symbol rate over the slot</p>
4	<p>Returns series of floating point numbers that show either active or inactive of each code returned in n=2 and 3. When the code is inactive, the result is 0.0, otherwise more than 0.0</p> <p>I and Q results are returned alternatively.</p> <p>1st number = 1st In Phase code active flag.          2nd number = 1st Quad Phase code active flag.          ...          (2*N-1)th number = Nth In Phase code active flag          (2*N)th number = Nth Quad Phase code active flag</p>
5	<p>Returns series of floating point numbers (in percent) that represent each sample in the EVM trace. The first number is the symbol 0 decision point and there are X points per symbol. Therefore, the decision points are at 0, 1xX, 2xX, 3xX...</p> <p>(X = the number of points per chip)</p>
6	<p>Returns series of floating point numbers (in percent) that represent each sample in the magnitude error trace. The first number is the symbol 0 decision point and there are X points per symbol. Therefore, the decision points are at 0, 1xX, 2xX, 3xX ...</p> <p>(X = the number of points per chip)</p>
7	<p>Returns series of floating point numbers (in degree) that represent each sample in the phase error trace. The first number is the symbol 0 decision point and there are X points per symbol. Therefore, the decision points are at 0, 1xX, 2xX, 3xX ...</p> <p>(X = the number of points per chip)</p>

8	<p>Returns series of floating point numbers that alternately represent I and Q pairs of the corrected measured trace. The magnitude of each I and Q pair are normalized to 1.0. The first number is the in-phase (I) sample of symbol 0 decision point and the second is the quadrature-phase (Q) sample of symbol 0 decision point. As in the EVM, there are X points per symbol, so that:</p> <p>1st number = I of the symbol 0 decision point          2nd number = Q of the symbol 0 decision point          ...          (2*X)+1th number = I of the symbol 1 decision point          (2*X)+2th number = Q of the symbol 1 decision point          ...          (2*X)*Nth + 1 number = I of the symbol N decision point          (2*X)*Nth + 2 number = Q of the symbol N decision point          (X = the number of points per chip)</p>
9	<p>Returns series of floating point numbers (in dBm) that represent the entire trace data of Symbol Power vs Time.</p>
10	<p>Returns series of floating point numbers (in dBm) that represent the entire trace data of Chip Power vs Time.</p>

- 11 Returns series of symbol values (in 0.0 or 1.0 ) for the selected code with entire capture length.
- In Subtype 2, Data channel take various modulation type, BPSK, QPSK and 8PSK.
- For BPSK modulation, the channel is spreading on I or Q branch and the queried data represents the sequence of I or Q or both of I and Q data.
- For QPSK modulation, the queried data represents alternating I and Q sequences as follows:
- 1st number = in-phase bit of the 1st I/Q pair
  - 2nd number = quad-phase bit of the 1st I/Q pair
  - 3rd number = in-phase bit of the 2nd I/Q pair
  - 4th number = quad-phase bit of the 2nd I/Q pair
  - .....
  - $(2*N-1)$ th number = in-phase bit of the Nth I/Q pair
  - $(2*N)$ th number = quad-phase bit of the Nth I/Q pair
- where N is the number of the symbols in the entire capture length.
- For 8PSK modulation, the queried data represents alternating  $s_0$ ,  $s_1$  and  $s_2$  sequence as follows:
- 1st number =  $s_0$  bit of the 1st symbol
  - 2nd number =  $s_1$  bit of the 1st symbol
  - 3rd number =  $s_2$  bit of the 1st symbol
  - 4th number =  $s_0$  bit of the 2nd symbol
  - 5th number =  $s_1$  bit of the 2nd symbol
  - 6th number =  $s_2$  bit of the 2nd symbol
  - ...
  - $(3*N-2)$  number =  $s_0$  bit of the Nth symbol
  - $(3*N-1)$  number =  $s_1$  bit of the Nth symbol
  - $(3*N)$  number =  $s_2$  bit of the Nth symbol
- where N is the number of the symbols in the capture length.
- If the modulation scheme changes within measurement period, the demod bits also changes following detected modulation scheme. User need to know the slot boundary using READ:TCDP14 modulation scheme result.

(Continued Next Page)

- 11 (Cont'd) ACK channel code domain power repeats ON and OFF every half slot. This kind of transmission is called “DTX (Discontinuous Transmission)”. ON slot and OFF slot automatically and the demod bit changes detected power. The demod bit with DTX represents “X” and distinguished from active part bit (0.0 and 1.0).
- 12 Returns series of floating point numbers (0.0 or 1.0) of symbol values for the selected code with the period selected by Meas Interval and Meas Offset.
- In Subtype 2, Data channel take various modulation type, BPSK, QPSK and 8PSK.
- For BPSK modulation, the channel is spreading on I or Q branch and the queried data represents the sequence of I or Q or both of I and Q data.
- For QPSK modulation, the queried data represents alternating I and Q sequences as follows:
- 1st number = in-phase bit of the 1st I/Q pair
  - 2nd number = quad-phase bit of the 1st I/Q pair
  - 3rd number = in-phase bit of the 2nd I/Q pair
  - 4th number = quad-phase bit of the 2nd I/Q pair
  - .....
  - (2\*N-1)th number = in-phase bit of the Nth I/Q pair
  - (2\*N)th number = quad-phase bit of the Nth I/Q pair
- where N is the number of the symbols in the selected time by Meas Interval and Meas Offset.
- For 8PSK modulation, the queried data represents alternating s0, s1 and s2 sequence as follows:
- 1st number = s0 bit of the 1st symbol
  - 2nd number = s1 bit of the 1st symbol
  - 3rd number = s2 bit of the 1st symbol
  - 4th number = s0 bit of the 2nd symbol
  - 5th number = s1 bit of the 2nd symbol
  - 6th number = s2 bit of the 2nd symbol
  - ...
  - (3\*N-2) number = s0 bit of the Nth symbol
- (Continued Next Page)

12 (3\*N-1) number = s1 bit of the Nth symbol

(Cont'd) (3\*N) number = s2 bit of the Nth symbol

where N is the number of the symbols in the selected time by Meas Interval and Meas offset.

If Packed mode (CALCulate:TCDPower:PCKM Off| PKM1) is set to PKM1, the representation of return value changes. Demod bits per symbol is packed into one floating point number in bit-slice manner as following.

For 8PSK modulation, s0 bit, s1 bit and s2 bit are packed into one floating number.

For QPSK modulation, in-phase bit of the 1st I/Q pair and quad-phase bit of the 1st I/Q pair are packed into one floating number.

For BPSK modulation, the packed demod bits and non-packed demod bits are same because BPSK modulation is 1bit per symbol modulation.

1st number = Packed Demod bits of 1st symbol

2nd number = Packed Demod bits of 2nd symbol

3rd number = Packed Demod bits of 3rd symbol

...

Nth number = Packed Demod bits of Nth symbol

Where N is the number of the symbols in the selected time by Meas Interval and Meas Offset.

If the modulation scheme changes within measurement period, the demod bits also changes following detected modulation scheme. User need to know the slot boundary using READ:TCDP14 modulation scheme result.

ACK channel code domain power repeats ON and OFF every half slot. This kind of transmission is called "DTX (Discontinuous Transmission)". ON slot and OFF slot automatically and the demod bit changes detected power. The demod bit with DTX represents "X" and distinguished from active part bit (0.0 and 1.0).



13 Returns a series of floating point numbers (in dB or dBm) that represents all the code domain errors.

If the active channel occupies more than the max spreading factor (38.4 ksp/s) the power is duplicated (active symbol rate / 38.4 ksp/s) times. (N=32)

1st number = 1st in-phase code domain error over the measurement period (1 slot specified by Meas Offset)

2nd number = 1st quad-phase code domain error over the measurement period (1 slot specified by Meas Offset)

...

(2\*N-1) number = N th in-phase code domain error over the measurement period (1 slot specified by Meas Offset)

(2\*N) number = N th quad-phase code domain error over the measurement period (1 slot specified by Meas Offset)

14 Returns a series of floating point numbers that represents the modulation scheme slot-by-slot.

The meaning of the number is :

0.0 = BPSK

1.0 = QPSK

2.0 = 8PSK

n = Meas Interval

1st number = Modulation Scheme of the slot specified by Meas Offset

2nd number = Modulation Scheme of the slot specified by Meas Offset + 1

3rd number = Modulation Scheme of the slot specified by Meas Offset + 2

...

Nth number = Modulation Scheme of the slot specified by Meas Offset + N

## Terminal Modulation Accuracy (Rho) Measurement

This measures the modulation accuracy of the 1xEV-DO terminal transmitter (mobile unit) by checking the magnitude and phase error and the EVM (error vector magnitude). You must be in the 1xEV-DO mode to use these commands. Use INSTRUMENT:SELect to set the mode.

For network access equipment, use MEAS:RHO to measure modulation accuracy, after selecting base transmitter stations using SENSE:RADio:DEVice BTS.

The general functionality of CONFigure, FETCh, MEASure, and READ are described at the beginning of this section. See the SENSE:RHO commands for more measurement related commands.

**:CONFigure:TRHO**

**:INITiate:TRHO**

**:FETCh:TRHO [n] ?**

**:READ:TRHO [n] ?**

**:MEASure:TRHO [n] ?**

Front Panel

Access: **Measure, Mod Accuracy**

After the measurement is selected, press **Restore Meas Defaults** to restore factory defaults.

### Measurement Results Available

Index: n	Result Returned
0	Returns unprocessed I/Q trace data of Capture Interval as a series of comma-separated trace points, in volts.

1	<p>Returns following 21 comma-separated scalar results, in the following order:</p> <p>#.Result Name (average mode) &lt;explanations&gt;</p> <p>average mode is:</p> <p>Average : Averaged value in average cycle</p> <p>Peak Hold : Detected Peak/Maximum value in average cycle</p> <ol style="list-style-type: none"> <li>1. RMS EVM (Average) – a floating point number (in percent) of EVM over the entire measurement area.</li> <li>2. Peak EVM (Peak Hold) – a floating point number (in percent) of peak EVM in the measurement area.</li> <li>3. Magnitude error (Average) – a floating point number (in percent) of average magnitude error over the entire measurement area.</li> <li>4. Phase error (Average) – a floating point number (in degree) of average phase error over the entire measurement area.</li> <li>5. I/Q Origin Offset (Average) – a floating point number (in dB) of the I and Q error (magnitude squared) offset from the origin.</li> <li>6. Frequency error (Average) – a floating point number (in Hz) of the frequency error in the measured signal.</li> <li>7. Rho (Average) – a floating point number of Rho.</li> <li>8. Peak Code Domain Error (Peak Hold) – a floating point number (in dB) of the Peak Code Domain Error relative to the mean power</li> <li>9. Peak Code Domain Error Channel Number (Peak Hold) – Returns the channel number that the peak is detected at the max spreading factor. (In MS, number = peak channel + (max spread number * (code == Q))).</li> <li>10. Number of active channels</li> <li>11. Pilot Offset (Average) – a floating point number (in micro seconds) of Pilot offset from the trigger point.</li> <li>12. Max Inactive Channel Code Domain Power (Peak Hold) – a floating point number (in dB) of the Max Inactive Channel Code Domain Power</li> <li>13. RRI Relative Power (Average) – a floating point number (in dB) of the RRI power relative to Pilot</li> <li>14. DRC Channel Relative Power (Average) – a floating point number (in dB) of the DRC Channel Power relative to Pilot</li> <li>15. ACK Channel Relative Power (Average) – a floating point number (in dB) of the ACK Channel Power relative to Pilot</li> </ol> <p>(Continued Next Page)</p>
---	--

<p>1 (Cont'd.)</p>	<p>16. Data Channel Relative Power (Average) – a floating point number (in dB) of summed up Data Channel Power relative to Pilot</p> <p>17. (Reserved) – (always -999)</p> <p>18. (Reserved) – (always -999)</p> <p>19. Auxiliary Pilot Channel Relative Power (Average) – a floating point number (in dB) of Auxiliary Pilot Channel Power relative to Pilot</p> <p>20. First Slot Number – a floating point number of first slot number. This is not averaged even if averaging in On.</p> <p>21. Total Power (Average) – a floating point number in dBm of total RF power over a measurement slot.</p>
<p>2</p>	<p>Returns series of floating point numbers (in percent) that represent each sample in the EVM trace of Capture Interval. The first number is the symbol 0 decision point and there are X points per symbol. Therefore, the decision points are at 0, 1xX, 2xX, 3xX...</p> <p>(X = the number of points per chip)</p>
<p>3</p>	<p>Returns series of floating point numbers (in percent) that represent each sample in the magnitude error trace of Capture Interval. The first number is the symbol 0 decision point and there are X points per symbol. Therefore, the decision points are at 0, 1xX, 2xX, 3xX ...</p> <p>(X = the number of points per chip)</p>
<p>4</p>	<p>Returns series of floating point numbers (in degree) that represent each sample in the phase error trace of Capture Interval. The first number is the symbol 0 decision point and there are X points per symbol. Therefore, the decision points are at 0, 1xX, 2xX, 3xX ...</p> <p>(X = the number of points per chip)</p>

5	<p>Returns series of floating point numbers that alternately represent I and Q pairs of the corrected measured trace of a half slot specified Meas Offset. The magnitude of each I and Q pair are normalized to 1.0. The first number is the in-phase (I) sample of symbol 0 decision point and the second is the quadrature-phase (Q) sample of symbol 0 decision point. As in the EVM, there are X points per symbol, so that:</p> <p>1st number = I of the symbol 0 decision point          2nd number = Q of the symbol 0 decision point          ...          (2xX)+1th number = I of the symbol 1 decision point          (2xX)+2th number = Q of the symbol 1 decision point          ...          (2xX)xNth + 1 number = I of the symbol N decision point          (2xX)xNth + 2 number = Q of the symbol N decision point          (X = the number of points per chip)</p>
6	<p>Returns 14 comma-separated scalar values of the pass/fail (0.0=passed, or 1.0=failed) results determined by testing the EVM, Peak EVM:</p> <ol style="list-style-type: none"> <li>1. Test result of EVM (Average)</li> <li>2. Test result of Peak EVM (Peak Hold)</li> <li>3. Test result of Rho (Average)</li> <li>4. Test result of Peak Code Domain Error (Peak Hold)</li> <li>5. Test result of Frequency Error (Average)</li> <li>6. Test result of Pilot Offset (Average)</li> <li>7. Test result of Max Inactive channel Code Domain Power (Peak Hold)</li> <li>8. Test result of RRI Relative power (Average)</li> <li>9. Test result of ACK Channel Relative Power (Average)</li> <li>10. Test result of DRC Channel Relative Power (Average)</li> <li>11. Test result of Data Channel Relative Power (Average)</li> <li>12. (Reserved) – (always -999)</li> <li>13. (Reserved) – (always -999)</li> <li>14. Test result of Auxiliary Pilot Channel Relative Power (Average)</li> </ol>

7	<p>From Code Domain Power View</p> <p>Returns series of floating point numbers of symbol rate, walsh code number, I or Q phase, power level (in dB), code domain error (in dB), time offset (in sec) and phase offset (in rad).</p> <p>The total numbers of results are equal to seven times the number of “Active channels”. The number of active channels can be obtained as the 10th result of FETCh:TRHO0 command.</p> <p>The results are as follows:</p> <p>1st number = Symbol Rate for 1st Active Channel</p> <p>2nd number = Walsh Code number for 1st Active Channel</p> <p>3rd number = 1 (I phase) or -1 (Q phase) or 0 (I and Q phase) for 1st Active Channel</p> <p>4th number = Power Level (in dB) for 1st Active Channel</p> <p>5th number = Code Domain Error (in dB) for 1st Active Channel</p> <p>6th number = Time Offset (in sec) for 1st Active Channel</p> <p>7th number = Phase Offset (in rad) for 1st Active Channel</p> <p>...</p> <p>(N-1)*7+1 number = Symbol Rate for Nth Active Channel</p> <p>(N-1)*7+2 number = Walsh Code number for Nth Active Channel</p> <p>(N-1)*7+3 number = 1 (I phase) or -1 (Q phase) or 0 (I and Q phase) for Nth Active Channel</p> <p>(N-1)*7+4 number = Power Level (in dB) for Nth Active Channel</p> <p>(N-1)*7+5 number = Code Domain Error (in dB) for Nth Active Channel</p> <p>(N-1)*7+6 number = Time Offset (in sec) for Nth Active Channel</p> <p>N*7 number = Phase Offset (in rad) for Nth Active Channel</p>
---	--

8	<p>Returns a series of floating point numbers (in dB) that represents all the code domain powers.</p> <p>Results are returned alternatively. Total is 32 I/Q pairs for Subtype 0/1 and 64 for Subtype 2. If the active channel occupies more than the max spreading factor (16 for Subtype 0/1 or 32 for Subtype 2) the power is duplicated.</p> <p>1st number = 1st in-phase code power over the slot</p> <p>2nd number = 1st quad-phase code power over the slot</p> <p>...</p> <p>(2PN-1)th number = Nth in-phase code power over the slot</p> <p>(2PN)th number = Nth quad-phase code power over a slot</p> <p>N = the number of codes detected. The total number of codes varies because of the different symbol rates of each code.</p>
---	---

9	<p>Average scalar results trace returns 28 comma-separated scalar results:</p> <ol style="list-style-type: none"> <li>1. RMS EVM – a floating point number (in percent) of EVM over the entire measurement area.</li> <li>2. Peak EVM – a floating point number (in percent) of peak EVM in the measurement area.</li> <li>3. Magnitude error - a floating point number (in percent) of average magnitude error over the entire measurement area.</li> <li>4. Phase error– a floating point number (in degree) of average phase error over the entire measurement area.</li> <li>5. I/Q Origin Offset – a floating point number (in dB) of the I and Q error (magnitude squared) offset from the origin.</li> <li>6. Frequency error – a floating point number (in Hz) of the frequency error in the measured signal.</li> <li>7. Rho – a floating point number of Rho.</li> <li>8. Peak Code Domain Error – a floating point number (in dB) of the Peak Code Domain Error relative to the mean power</li> <li>9. Peak Code Domain Error Channel Number – Returns the channel number that the peak is detected at the max spreading factor. (In MS, number = peak channel + (max spread number * (code == Q))).</li> <li>10. Number of active channels</li> <li>11. Pilot Offset – a floating point number (in micro seconds) of Pilot offset from the trigger point.</li> <li>12. Max Inactive Channel Code Domain Power – a floating point number (in dB) of the Max Inactive Channel Code Domain Power</li> <li>13. Pilot Power – a floating point number (in dB) of the Pilot power</li> <li>14. RRI Power – a floating point number (in dB) of the RRI power</li> <li>15. RRI Relative Power – a floating point number (in dB) of the RRI power relative to Pilot</li> <li>16. DRC Power – a floating point number (in dB) of the DRC power</li> <li>17. DRC Channel Relative Power – a floating point number (in dB) of the DRC Channel Power relative to Pilot</li> <li>18. ACK Power – a floating point number (in dB) of the ACK power</li> <li>19. ACK Channel Relative Power – a floating point number (in dB) of the ACK Channel Power relative to Pilot</li> <li>20. Data Power on – a floating point number (in dB) of summed up Data Channel Power</li> </ol> <p>(Continued Next Page)</p>
---	---



9 (Cont'd.)	<p>21. Data Channel Relative Power – a floating point number (in dB) of the summed up Data Channel Power relative to Pilot</p> <p>22. (Reserved) – (always -999)</p> <p>23. (Reserved) – (always -999)</p> <p>24. (Reserved) – (always -999)</p> <p>25. (Reserved) – (always -999)</p> <p>26. Auxiliary Pilot Power – a floating point number (in dB) of the Auxiliary Pilot power</p> <p>27. Auxiliary Pilot Channel Relative Power – a floating point number (in dB) of Auxiliary Pilot Channel Power relative to Pilot</p> <p>28. Total Power – a floating point number in dBm of total RF power over a measurement slot.</p>
-------------	--

10	<p>Peak Hold scalar results trace returns 28 comma-separated scalar results:</p> <ol style="list-style-type: none"> <li>1. RMS EVM – a floating point number (in percent) of EVM over the entire measurement area.</li> <li>2. Peak EVM – a floating point number (in percent) of peak EVM in the measurement area.</li> <li>3. Magnitude error - a floating point number (in percent) of average magnitude error over the entire measurement area.</li> <li>4. Phase error– a floating point number (in degree) of average phase error over the entire measurement area.</li> <li>5. I/Q Origin Offset – a floating point number (in dB) of the I and Q error (magnitude squared) offset from the origin.</li> <li>6. Frequency error – a floating point number (in Hz) of the frequency error in the measured signal.</li> <li>7. Rho – a floating point number of Rho.</li> <li>8. Peak Code Domain Error – a floating point number (in dB) of the Peak Code Domain Error relative to the mean power</li> <li>9. Peak Code Domain Error Channel Number – Returns the channel number that the peak is detected at the max spreading factor. (In MS, number = peak channel + (max spread number * (code == Q))).</li> <li>10. Number of active channels</li> <li>11. Pilot Offset – a floating point number (in micro seconds) of Pilot offset from the trigger point.</li> <li>12. Max Inactive Channel Code Domain Power – a floating point number (in dB) of the Max Inactive Channel Code Domain Power</li> <li>13. Pilot Power – a floating point number (in dB) of the Pilot power</li> <li>14. RRI Power – a floating point number (in dB) of the RRI power</li> <li>15. RRI Relative Power – a floating point number (in dB) of the RRI power relative to Pilot</li> <li>16. DRC Power – a floating point number (in dB) of the DRC power</li> <li>17. DRC Channel Relative Power – a floating point number (in dB) of the DRC Channel Power relative to Pilot</li> <li>18. ACK Power – a floating point number (in dB) of the ACK power</li> <li>19. ACK Channel Relative Power – a floating point number (in dB) of the ACK Channel Power relative to Pilot</li> <li>20. Data Power – a floating point number (in dB) of the summed up Data Channel Power</li> </ol>
----	---

10 (Cont'd)	21. Data Channel Relative Power – a floating point number (in dB) of the summed up Data Channel Power relative to Pilot 22. (Reserved) – (always -999) 23. (Reserved) – (always -999) 24. (Reserved) – (always -999) 25. (Reserved) – (always -999) 26. Auxiliary Pilot Power – a floating point number (in dB) of the Auxiliary Pilot power 27. Auxiliary Pilot Channel Relative Power – a floating point number (in dB) of Auxiliary Pilot Channel Power relative to Pilot. 28. Total Power – a floating point number in dBm of total RF power over a measurement slot.
----------------	--

## Waveform (Time Domain) Measurement

For E4406A this measures the amplitude of your input signal with respect to the frequency. It provides spectrum analysis capability using FFT (fast Fourier transform) measurement techniques. You must select the appropriate mode using INSTRUMENT:SElect, to use these commands.

For PSA this measures the amplitude of your input signal with respect to the frequency. It provides spectrum analysis capability using FFT (fast Fourier transform) measurement techniques. You must be in the Basic, cdmaOne, cdma2000, 1xEV-DO, W-CDMA, GSM (w/EDGE), NADC, or PDC mode to use these commands. Use INSTRUMENT:SElect, to select the mode.

The general functionality of CONFigure, FETCh, MEASure, and READ are described at the beginning of this section. See the SENSE:WAVEform commands for more measurement related commands.

```
:CONFigure:WAVEform
:INITiate:WAVEform
:FETCh:WAVEform[n]?
:READ:WAVEform[n]?
:MEASure:WAVEform[n]?
```

Front Panel

Access: **Measure, Waveform (Time Domain)**

After the measurement is selected, press **Restore Meas Defaults** to restore factory defaults.

### Measurement Results Available

<b>n</b>	<b>Results Returned</b>
0 (see also 5)	Returns unprocessed I/Q trace data, as a series of trace point values, in volts. The I values are listed first in each pair, using the 0 through even-indexed values. The Q values are the odd-indexed values.

<b>n</b>	<b>Results Returned</b>
n=1 (or not specified)	<p>Returns the following 7 scalar results:</p> <ol style="list-style-type: none"> <li>1. Sample time is a floating point number representing the time between samples when using the trace queries (n=0,2,etc).</li> <li>2. Mean power is the mean power (in dBm). This is either the power across the entire trace, or the power between markers if the markers are enabled. If averaging is on, the power is for the latest acquisition.</li> <li>3. Mean power averaged is the power (in dBm) for N averages, if averaging is on. This is either the power across the entire trace, or the power between markers if the markers are enabled. If averaging is on, the power is for the latest acquisition. If averaging is off, the value of the mean power averaged is the same as the value of the mean power.</li> <li>4. Number of samples is the number of data points in the captured signal. This number is useful when performing a query on the signal (i.e. when n=0,2,etc.).</li> <li>5. Peak-to-mean ratio has units of dB. This is the ratio of the maximum signal level to the mean power. Valid values are only obtained with averaging turned off. If averaging is on, the peak-to-mean ratio is calculated using the highest peak value, rather than the displayed average peak value.</li> <li>6. Maximum value is the maximum of the most recently acquired data (in dBm).</li> <li>7. Minimum value is the minimum of the most recently acquired data (in dBm).</li> </ol>
2	<p>Returns trace point values of the entire captured signal envelope trace data. These data points are floating point numbers representing the power of the signal (in dBm). There are N data points, where N is the number of samples. The period between the samples is defined by the sample time.</p>

## READ Subsystem

The READ? commands are used with several other commands and are documented in the section on the “MEASure Group of Commands” on [page 375](#).

### Initiate and Read Measurement Data

**:READ: <measurement> [n] ?**

A READ? query must specify the desired measurement. It will cause a measurement to occur without changing any of the current settings and will return any valid results. The code number n selects the kind of results that will be returned. The available measurements and data results are described in the “MEASure Group of Commands” on [page 375](#).

## SENSe Subsystem

These commands are used to set the instrument state parameters so that you can measure a particular input signal. Some SENSe commands are only for use with specific measurements found under the MEASURE key menu or the “MEASure Group of Commands” on page 375. The measurement must be active before you can use these commands.

The SCPI default for the format of any data output is ASCII. The format can be changed to binary with FORMat:DATA which transports faster over the bus.

### Code Domain Measurement

Commands for querying the code domain power measurement results and for setting to the default values are found in the “MEASure Group of Commands” on page 375. The equivalent front panel keys for the parameters described in the following commands, are found under the **Meas Setup** key, after the **Code Domain** measurement has been selected from the **MEASURE** key menu.

#### Code Domain Measurement — Active Data Channel

```
[ :SENSe ] :CDPower :ACode AUTO | PREDeFined
```

```
[ :SENSe ] :CDPower :ACode?
```

Select the Active Channel ID detection mode Auto or Predefined.

AUTO - detects Active Channel ID for Data Channel automatically.

PREDeFined - set predefined Active Channel (all channel codes) for Data Channel.

Factory Preset: AUTO

Remarks: You must be in the 1xEV-DO mode to use this command. Use INSTRument:SElect to set the mode.

#### Code Domain Measurement — ADC Range

PSA

```
[ :SENSe ] :CDPower :ADC :RANGe
```

```
AUTO | APEak | APLock | NONE | P0 | P6 | P12 | P18
```

E4406A

```
[ :SENSe ] :CDPower :ADC :RANGe
```

```
AUTO | APEak | APLock | M6 | P0 | P6 | P12 | P18 | P24
```

```
[ :SENSe ] :CDPower :ADC :RANGe?
```

Select a ranging function for the ADC gain control. This is an advanced control that normally does not need to be changed. If you are measuring a CW signal, see the following description:

- **AUTO** - automatic ranging  
For FFT spectrums, the auto ranging should not be used. An exception to this would be if you know that your signal is “bursty”. Then you might use auto to maximize the time domain dynamic range as long as you are not very interested in the FFT data.
- **APEak (Auto Peak)** - automatic ranging to the peak signal level  
For CW signals, the default of auto-peak ranging can be used, but a better FFT measurement of the signal can be made by selecting one of the manual ranges that is available by specifying M6, or P0 through P24.  
Auto peaking can cause the ADC gain to monotonically track the ranges down during the data capture. This tracking effect should be negligible for the FFT spectrum, but selecting a manual range solves this possibility. Note that if the CW signal being measured is close to the auto-ranging threshold, the noise floor may shift as much as 6 dB every sweep.
- **APLock (Auto Peak Lock)** - automatic ranging locked to the peak signal level  
For CW signals, auto-peak lock ranging may be used. It will find the ADC gain most appropriate for this particular signal and will not track the ranges as auto-peak can. Note that if the CW signal being measured is close to the auto-ranging threshold, the noise floor may shift as much as 6 dB every sweep.  
For “bursty” signals, auto-peak lock ranging should not be used. Since the ADC range can often be locked to the wrong one resulting in overloading the ADC, the measurement will fail.
- **NONE** - (PSA) turns off any auto-ranging without making any changes to the current setting.
- **M6** - (E4406A) manually selects an ADC range that subtracts 6 dB from the fixed gain across the range. Manual ranging is best for CW signals. This is the default selection for this measurement.
- **P0 thru P24** - (E4406A) manually selects one of the ADC ranges that add 0 dB to 24 dB to the fixed gain across the range. Manual ranging is best for CW signals.
- **P0 thru P18** - (PSA) manually selects one of the ADC ranges that add 0 dB to 24 dB to the fixed gain across the range. Manual ranging is best for CW signals.

Factory Preset: M6



Remarks: You must be in the 1xEV-DO mode to use this command. Use INSTRUMENT:SElect to set the mode.

History: PSA:  
Added in version A.02.00  
  
E4406A:  
Added in version A.05.00

### Code Domain—Data Capture Time

**[ :SENSE ] :CDPower:CAPture:TIME <numeric>**

**[ :SENSE ] :CDPower:CAPture:TIME?**

Set the data capture length in Power Control Groups (PCG; 1 PCG equals 1.25 ms) for cdma2000 and 1xEV-DO, or frames (1 frame equals 10 ms) for W-CDMA that will be used in the acquisition.

For cdma2000 Set the data capture length in Power Control Groups (PCG; 1 PCG equals 1.25 ms) that will be used in the acquisition.

For 1xEV-DO Set the data capture length in units of slots (1 slot equals 1.667 ms) that will be used in the acquisition.

For W-CDMA Set the data capture length in frames (1 frame equals 10 ms) for that will be used in the acquisition.

Factory Preset: 5 for cdma2000, 1xEV-DO

2.0 for W-CDMA

Range: 2 to 32 PCGs (2.5 to 40 ms) for cdma2000; 2 to 32 slots for 1xEV-DO

0.067 (any value below 1 is set to 0.067), 1.0, 2.0, 3.0, 4.0, and 8.0 frames (0.67 to 80 ms; 1/15 frame equals 1 slot) for W-CDMA. Other numeric values between 1 and 8 are rounded to the nearest integer; entries between integers are rounded up, excepting for entries above 8 which are rounded down to 8.

Remarks: You must be in the cdma2000, W-CDMA, or 1xEV-DO mode to use this command. Use INSTRUMENT:SElect to set the mode.

### Code Domain—Chip Rate

**[ :SENSE ] :CDPower:CRATe <freq>**

**[ :SENSE ] :CDPower:CRATe?**

Enter a frequency value to set the chip rate.

Factory Preset: 1.2288 MHz for cdma2000, 1xEV-DO

3.84 MHz for W-CDMA

Range: 1.10592 to 1.35168 MHz for cdma2000, 1xEV-DO

3.456 to 4.224 MHz for W-CDMA

Remarks: You must be in the cdma2000, W-CDMA, or 1xEV-DO mode to use this command. Use INSTRument:SElect to set the mode.

### Code Domain—Phase Compensation by Pilot

`[[:SENSe]:CDPower:PIlot:COMPensation[:STATE] OFF|ON|0|1`

`[[:SENSe]:CDPower:PIlot:COMPensation[:STATE]?`

Turn on or off the phase compensation (1 slot-based compensation)

Factory Preset: Off

On - Perform 1 slot-based phase compensation

Off - Do not perform 1 slot-based phase compensation

Remarks: You must be in the 1xEV-DO mode to use this command. Use INSTRument:SElect to set the mode.

### Code Domain—PN Offset

`[[:SENSe]:CDPower:PNOffset <integer>`

`[[:SENSe]:CDPower:PNOffset?`

Set a PN sequence number for the base station being tested. This value behaves as a multiplier for the Walsh codes of which length is in the unit of 64 chips.

Factory Preset: 0

Range: 0 to 511

Unit: 64 chips

Remarks: You must be in the 1xEV-DO mode to use this command. Use INSTRument:SElect to set the mode.

History: PSA:  
Added in version A.02.00

E4406A:  
Added in version A.05.00

### Code Domain—Preamble Length

**[ :SENSE ] :CDPower:PREamble:LENGth <integer>**

**[ :SENSE ] :CDPower:PREamble:LENGth?**

Set the Preamble length manually in chips.

Factory Preset: 0

Range: 0, 64, 128, 256, 512 and 1024

Remarks: You must be in the 1xEV-DO mode to use this command. Use INSTRUMENT:SElect to set the mode.

### Code Domain—Preamble Auto Detection

**[ :SENSE ] :CDPower:PREamble:LENGth:AUTO OFF | ON | 0 | 1**

**[ :SENSE ] :CDPower:PREamble:LENGth:AUTO?**

Turn the Preamble Length detection mode on or off.

On - detects the Preamble length automatically.

Off - sets the Preamble length manually by  
[:SENSE]:CDPower:PREamble:LENGth.

Factory Preset: ON

Remarks: You must be in the 1xEV-DO mode to use this command. Use INSTRUMENT:SElect to set the mode.

### Code Domain—Spectrum Normal/Invert

**[ :SENSE ] :CDPower:SPECTrum INVert | NORMal**

**[ :SENSE ] :CDPower:SPECTrum?**

Set a spectrum either to normal or inverted for the demodulation related measurements. If set to INVert, the upper and lower spectrums are swapped.

Factory Preset: NORMal

Remarks You must be in the cdmaOne, cdma2000, W-CDMA, or 1xEV-DO mode to use this command. Use INSTRUMENT:SElect to set the mode.

### Code Domain—Trigger Source

```
[ :SENSe ] :CDPower:TRIGger:SOURceEXTERNAL [1] | External2 | FRAMe  
| IF | IMMEDIATE | RFBURSt
```

```
[ :SENSe ] :CDPower:TRIGger:SOURce?
```

Select one of the trigger sources used to control the data acquisitions.

EXTernal 1 – front panel external trigger input

EXTernal 2 – rear panel external trigger input

FRAMe – internal frame trigger

IF – internal IF envelope (video) trigger

IMMEDIATE – the next data acquisition is immediately taken, capturing the signal asynchronously (also called free run).

RFBURSt – internal wideband RF burst envelope trigger that has automatic level control for periodic burst signals.

Factory Preset: IMMEDIATE

Remarks: You must be in the cdma2000, W-CDMA, or 1xEV-DO mode to use this command. Use INSTRUMENT:SELEct to set the mode.

Front Panel

Access: **Meas Setup, Trig Source**

## Channel Power Measurement

Commands for querying the channel power measurement results and for setting to the default values are found in the “[MEASure Group of Commands](#)” on page 375. The equivalent front panel keys for the parameters described in the following commands, are found under the **Meas Setup** key, after the **Channel Power** measurement has been selected from the **MEASURE** key menu.

### Channel Power—Averaging State

**[ :SENSE ] :CHPower:AVERAge [ :STATE ] OFF | ON | 0 | 1**

**[ :SENSE ] :CHPower:AVERAge [ :STATE ] ?**

Turn averaging on or off.

Factory Preset: ON

Remarks: For PSA you must be in the cdmaOne, cdma2000, W-CDMA, or 1xEV-DO mode to use this command. Use INSTRUMENT:SELEct to set the mode.

For E4406A you must be in the Basic, cdmaOne, cdma2000, W-CDMA, or 1xEV-DO mode to use this command. Use INSTRUMENT:SELEct to set the mode.

### Channel Power—Averaging Termination Control

**[ :SENSE ] :CHPower:AVERAge:TCONtrol EXPonential | REPEAT**

**[ :SENSE ] :CHPower:AVERAge:TCONtrol ?**

Select the type of termination control used for the averaging function. This determines the averaging action after the specified number of data acquisitions (average count) is reached.

EXPonential - Each successive data acquisition after the average count is reached, is exponentially weighted and combined with the existing average.

REPEAT - After reaching the average count, the averaging is reset and a new average is started.

Factory Preset: REPEAT

Remarks: For PSA you must be in the cdmaOne, cdma2000, W-CDMA, or 1xEV-DO mode to use this command. Use INSTRUMENT:SELEct to set the mode.

For E4406A you must be in the Basic, cdmaOne, cdma2000, W-CDMA, or 1xEV-DO mode to use this command. Use INSTRUMENT:SELEct to set the mode.

### Channel Power—Span

**[ :SENSe ] :CHPower:FREQuency:SPAN <freq>**

**[ :SENSe ] :CHPower:FREQuency:SPAN?**

Set the frequency span that will be used.

Factory Preset: 2.0 MHz for Basic, cdmaOne, cdma2000, 1xEV-DO  
6.0 MHz for W-CDMA

Range: Dependent on the current setting of the channel power integration bandwidth

Default Unit: Hz

Remarks: For PSA you must be in the cdmaOne, cdma2000, W-CDMA, or 1xEV-DO mode to use this command. Use INSTRument:SElect to set the mode.

For E4406A you must be in the Basic, cdmaOne, cdma2000, W-CDMA, or 1xEV-DO mode to use this command. Use INSTRument:SElect to set the mode.

### Channel Power—Data Points

**[ :SENSe ] :CHPower:POINTs <integer>**

**[ :SENSe ] :CHPower:POINTs?**

Set the number of data points that will be used. Changing this will change the time record length and resolution BW that are used.

Factory Preset: 512

Range: 64 to 32768, in a 2<sup>n</sup> sequence

Remarks: For PSA you must be in the cdmaOne, cdma2000, W-CDMA, or 1xEV-DO mode to use this command. Use INSTRument:SElect to set the mode.

For E4406A you must be in the Basic, cdmaOne, cdma2000, W-CDMA, or 1xEV-DO mode to use this command. Use INSTRument:SElect to set the mode.

### Channel Power—Data Points Auto

**[ :SENSe ] :CHPower:POINTs:AUTO OFF|ON|0|1**

**[ :SENSe ] :CHPower:POINTs:AUTO?**

Select auto or manual control of the data points. This is an advanced control that normally does not need to be changed. Setting this to a value other than the factory default, may cause invalid measurement

results.

OFF - the Data Points is uncoupled from the Integration BW.

ON - couples the Data Points to the Integration BW.

Factory Preset: ON

Remarks: You must be in the Basic (E4406A), cdmaOne, cdma2000, W-CDMA, 1xEV-DO mode to use this command. Use INSTRument:SElect to set the mode.

### Channel Power—Sweep Time

**[ :SENSe ] :CHPower :SWEEP :TIME <time>**

**[ :SENSe ] :CHPower :SWEEP :TIME ?**

Sets the sweep time when using the sweep mode.

Factory Preset: 68.27  $\mu$ s

17.07  $\mu$ s for W-CDMA

Range: 1  $\mu$ s to 50 ms

Default Unit: seconds

Remarks: You must be in the Basic (E4406A), cdmaOne, cdma2000, W-CDMA, or 1xEV-DO mode to use this command. Use INSTRument:SElect to set the mode.

History: E4406A:  
Version A.03.00 and later

### Channel Power—Sweep Time

**[ :SENSe ] :CHPower :SWEEP :TIME :AUTO OFF | ON | 0 | 1**

**[ :SENSe ] :CHPower :SWEEP :TIME :AUTO ?**

Selects the automatic sweep time, optimizing the measurement.

Factory Preset: ON

Remarks: You must be in the Basic (E4406A), cdmaOne, cdma2000, W-CDMA, or 1xEV-DO mode to use this command. Use INSTRument:SElect to set the mode.

History: E4406A:  
Version A.03.00 and later

## Channel Power—Trigger Source

**[ :SENSe ] :CHPower:TRIGger:SOURce  
EXTErnal [1] | EXTErnal2 | IMMEDIATE**

**[ :SENSe ] :CHPower:TRIGger:SOURce?**

Select the trigger source used to control the data acquisitions. This is an Advanced control that normally does not need to be changed.

EXTErnal 1 - front panel external trigger input

EXTErnal 2 - rear panel external trigger input

IMMEDIATE - the next data acquisition is immediately taken (also called Free Run).

Factory Preset: IMMEDIATE

Remarks: For PSA you must be in the cdmaOne, cdma2000, W-CDMA, or 1xEV-DO mode to use this command. Use INSTRUMENT:SELEct to set the mode.

For E4406A you must be in the Basic, cdmaOne, cdma2000, W-CDMA, or 1xEV-DO mode to use this command. Use INSTRUMENT:SELEct to set the mode.



## Signal Corrections Commands

### Correction for BTS RF Port External Attenuation

**[ :SENSE ] :CORREction:BTS [ :RF ] :LOSS <rel\_power>**

**[ :SENSE ] :CORREction:BTS [ :RF ] :LOSS?**

Set equal to the external attenuation used when measuring base transmission stations.

Factory Preset: 0.0 dB

Range:            -50 to 100.0 dB for GSM, EDGE  
                  -100.0 to 100.0 dB for cdma2000, W-CDMA, 1xEV-DO

Default Unit:   dB

Remarks:        Global to the current mode.

You must be in the GSM, EDGE, cdma2000, W-CDMA, or 1xEV-DO mode to use this command. Use INSTRUMENT:SElect to set the mode.

### Correction for MS RF Port External Attenuation

**[ :SENSE ] :CORREction:MS [ :RF ] :LOSS <rel\_power>**

**[ :SENSE ] :CORREction:MS [ :RF ] :LOSS?**

Set the correction equal to the external attenuation used when measuring mobile stations.

Factory Preset: 0.0 dB

Range:            -50 to 100.0 dB for cdmaOne, GSM, EDGE, iDEN  
                  -100.0 to 100.0 dB for cdma2000, W-CDMA, 1xEV-DO  
                  -50.0 to 50.0 dB for NADC, PDC

Default Unit:   dB

Remarks:        For E4406A you must be in the cdmaOne, GSM, EDGE (w/GSM), cdma2000, W-CDMA, iDEN, NADC, PDC, or 1xEV-DO mode to use this command. Use INSTRUMENT:SElect to set the mode.

For PSA you must be in the cdmaOne, GSM (w/EDGE), cdma2000, W-CDMA, NADC, PDC, or 1xEV-DO mode to use this command. Use INSTRUMENT:SElect to set the mode.

Value is global to the current mode.

## QPSK Error Vector Magnitude Measurement

Commands for querying the QPSK error vector magnitude measurement results and for setting to the default values are found in the “MEASure Group of Commands” on page 375. The equivalent front panel keys for the parameters described in the following commands, are found under the **Meas Setup** key, after the **QPSK EVM** measurement has been selected from the **MEASURE** key menu.

### QPSK Error Vector Magnitude — ADC Range

PSA

[ :SENSe ] :EVMQpsk:ADC:RANGe

AUTO | APEak | APLock | NONE | P0 | P6 | P12 | P18

E4406A

[ :SENSe ] :EVMQpsk:ADC:RANGe

AUTO | APEak | APLock | M6 | P0 | P6 | P12 | P18 | P24

[ :SENSe ] :EVMQpsk:ADC:RANGe?

Select a ranging function for the ADC gain control. This is an advanced control that normally does not need to be changed. If you are measuring a CW signal, see the following description:

- AUTO - automatic ranging

For FFT spectrums, the auto ranging should not be used. An exception to this would be if you know that your signal is “bursty”. Then you might use auto to maximize the time domain dynamic range as long as you are not very interested in the FFT data.

- APEak (Auto Peak) - automatic ranging to the peak signal level

For CW signals, the default of auto-peak ranging can be used, but a better FFT measurement of the signal can be made by selecting one of the manual ranges that is available by specifying M6, or P0 through P24.

Auto peaking can cause the ADC gain to monotonically track the ranges down during the data capture. This tracking effect should be negligible for the FFT spectrum, but selecting a manual range solves this possibility. Note that if the CW signal being measured is close to the auto-ranging threshold, the noise floor may shift as much as 6 dB every sweep.

- APLock (Auto Peak Lock) - automatic ranging locked to the peak signal level

For CW signals, auto-peak lock ranging may be used. It will find the ADC gain most appropriate for this particular signal and will not track the ranges as auto-peak can. Note that if the CW signal being measured is close to the auto-ranging threshold, the noise floor may shift as much as 6 dB every sweep.

For “bursty” signals, auto-peak lock ranging should not be used. Since the ADC range can often be locked to the wrong one resulting in overloading the ADC, the measurement will fail.

- NONE - (PSA) turns off any auto-ranging without making any changes to the current setting.
- M6 - (E4406A) manually selects an ADC range that subtracts 6 dB from the fixed gain across the range. Manual ranging is best for CW signals.
- P0 thru P18 - (PSA) manually selects one of the ADC ranges that add 0 dB to 24 dB to the fixed gain across the range. Manual ranging is best for CW signals.
- P0 thru P24 - (E4406A) manually selects one of the ADC ranges that add 0 dB to 24 dB to the fixed gain across the range. Manual ranging is best for CW signals.

Factory Preset: M6

Remarks: You must be in the 1xEV-DO mode to use this command. Use INSTRument:SElect to set the mode.

History: PSA:  
Added in version A.02.00  
  
E4406A:  
Added in version A.05.00

### QPSK Error Vector Magnitude—Average Count

**[ :SENSe ] :EVMQpsk:AVERAge:COUNT <integer>**

**[ :SENSe ] :EVMQpsk:AVERAge:COUNT ?**

Set the number of data acquisitions that will be averaged. After the specified number of average counts, the average mode (termination control) setting determines the average action.

Factory Preset: 10

Range: 1 to 10,000

Remarks: You must be in the cdma2000, W-CDMA, or 1xEV-DO mode to use this command. Use INSTRument:SElect to set the mode.

### QPSK Error Vector Magnitude—Averaging State

**[ :SENSe ] :EVMQpsk:AVERAge [ :STATe ] OFF | ON | 0 | 1**

**[ :SENSe ] :EVMQpsk:AVERAge [ :STATe ] ?**

Turn the averaging function on or off.

Factory Preset: ON

Remarks: You must be in the cdma2000, W-CDMA, or 1xEV-DO mode to use this command. Use INSTRument:SElect to set the mode.

### QPSK Error Vector Magnitude—Averaging Termination Control

**[ :SENSe ] :EVMQpsk :AVERage :TCONtrol EXPonential | REPEAT**

**[ :SENSe ] :EVMQpsk :AVERage :TCONtrol ?**

Select the type of termination control used to averaging. This determines the averaging action after the specified number of data acquisitions (average count) is reached.

EXPonential – Each successive data acquisition after the average count is reached, is exponentially weighted and combined with the existing average.

REPEAT – After reaching the average count, the averaging is reset and a new average is started.

Factory Preset: REPEAT

Remarks: You must be in the cdma2000, W-CDMA, or 1xEV-DO mode to use this command. Use INSTRument:SElect to set the mode.

### QPSK Error Vector Magnitude—Chip Rate

**[ :SENSe ] :EVMQpsk :CRATe <freq>**

**[ :SENSe ] :EVMQpsk :CRATe ?**

Enter a frequency value to set the chip rate.

Factory Preset: 1.2288 MHz for cdma2000, 1xEV-DO  
3.84 MHz for W-CDMA

Range: 1.10592 to 1.35168 MHz for cdma2000, 1xEV-DO  
3.456 to 4.224 MHz for W-CDMA

Default Unit: Hz

Remarks: You must be in the cdma2000, W-CDMA, or 1xEV-DO mode to use this command. Use INSTRument:SElect to set the mode.

### QPSK Error Vector Magnitude—RF Carrier Mode

**[ :SENSe ] :EVMQpsk:RFCarrier MULTiple | SINGle**

**[ :SENSe ] :EVMQpsk:RFCarrier?**

Select either the single carrier mode or the multiple carrier mode.

**MULTiple** – The measurement assumes that the input signal is the multiple carriers with adjacent channel signals. The filter is used to cut the adjacent channel signals. (The filter may affect the measurement result.)

**SINGle** – The measurement assumes that the input signal is the single carrier without adjacent channel signals. No filter is used for better measurement.

Factory Preset: SINGle

Remarks: You must be in the cdma2000 or 1xEV-DO mode to use this command. Use INSTRument:SElect to set the mode.

### QPSK Error Vector Magnitude—Measurement Interval

**[ :SENSe ] :EVMQpsk:SWEep:POINTs <integer>**

**[ :SENSe ] :EVMQpsk:SWEep:POINTs?**

Set the number of data points that will be used as the measurement interval.

Factory Preset: 96 chips

Range: 32 to 2048 chips

Remarks: You must be in the 1xEV-DO mode to use this command. Use INSTRument:SElect to set the mode.

### QPSK Error Vector Magnitude—Measurement Offset

**[ :SENSe ] :EVMQpsk:SWEep:POINTs:OFFSet <number>**

**[ :SENSe ] :EVMQpsk:SWEep:POINTs:OFFSet?**

Set the number of data points that will be offset.

Factory Preset: 464.0 chips

Range: 22.0 to 2048.0 chips

Remarks: You must be in the 1xEV-DO mode to use this command. Use INSTRument:SElect to set the mode.

History: PSA:

Added in version A.02.00

E4406A:

Added in version A.05.00

### QPSK Error Vector Magnitude—Trigger Source

**[ :SENSe ] :EVMQpsk:TRIGger:SOURce  
EXTErnal [1] | EXTErnal2 | FRAMe | IF | IMMEDIATE | RFBurst**

**[ :SENSe ] :EVMQpsk:TRIGger:SOURce?**

Select one of the trigger sources used to control the data acquisitions.

EXTErnal 1 – front panel external trigger input

EXTErnal 2 – rear panel external trigger input

FRAMe – internal frame trigger

IF – internal IF envelope (video) trigger

IMMEDIATE – the next data acquisition is immediately taken, capturing the signal asynchronously (also called free run)

RFBurst – wideband RF burst envelope trigger that has automatic level control for periodic burst signals

Factory Preset: IMMEDIATE

Remarks: You must be in the cdma2000, W-CDMA, or 1xEV-DO mode to use this command. Use INSTRument:SElect to set the mode.

## RF Input Signal Alignments

### Select the Input Signal

(PSA)

```
[ :SENSe] :FEED RF | AREFERENCE | IFALIGN
```

(E4406A)

```
[ :SENSe] :FEED RF | IQ | IONLY | QONLY | AREFERENCE | IFALIGN
```

```
[ :SENSe] :FEED?
```

Selects the input signal. The default input signal is taken from the front panel RF input port. For calibration and testing purposes the input signal can be taken from an internal 321.4 MHz IF alignment signal or an internal 50 MHz amplitude reference source.

For E4406A if the baseband IQ option (Option B7C) is installed, I and Q input ports are added to the front panel. The I and Q ports accept the in-phase and quadrature components of the IQ signal, respectively. The input signal can be taken from either or both ports.

RF selects the signal from the front panel RF INPUT port.

IQ selects the combined signals from the front panel optional I and Q input ports. (E4406A with Option B7C in Basic, W-CDMA, cdma2000, EDGE(w/GSM) modes)

IONLY selects the signal from the front panel optional I input port. (E4406A with Option B7C in Basic mode)

QONLY selects the signal from the front panel optional Q input port. (E4406A with Option B7C in Basic mode)

AREFERENCE selects the internal 50 MHz amplitude reference signal.

IFALIGN selects the internal, 321.4 MHz, IF alignment signal.

Factory Preset: RF

Front Panel

Access: **Input, Input Port**

History: E4406A:  
modified in version A.05.00

## Intermodulation Measurement

Commands for querying the intermodulation measurement results and for setting to the default values are found in the “MEASure Group of Commands” on page 375. The equivalent front panel keys for the parameters described in the following commands, are found under the **Meas Setup** key, after the **Intermod** measurement has been selected from the **MEASURE** key menu.

History: E4406A:  
Added version A.04.00 and later

### Intermodulation—Average Count

**[ :SENSe ] :IM:AVERAge:COUNT <number>**

**[ :SENSe ] :IM:AVERAge:COUNT?**

Set the number of data acquisitions that will be averaged. After the specified number of average counts, the average mode (termination control) setting determines the average action.

Factory Preset: 10

Range: 1 to 10,000

Remarks: You must be in the cdma2000, W-CDMA, or 1xEV-DO mode to use this command. Use INSTRument:SElect to set the mode.

### Intermodulation—Averaging State

**[ :SENSe ] :IM:AVERAge[:STATe] OFF|ON|0|1**

**[ :SENSe ] :IM:AVERAge[:STATe]?**

Turn the averaging function on or off.

Factory Preset: ON

Remarks: You must be in the cdma2000, W-CDMA, or 1xEV-DO mode to use this command. Use INSTRument:SElect to set the mode.

### Intermodulation—Averaging Termination Control

**[ :SENSe ] :IM:AVERAge:TCONtrol EXPonential|REPeat**

**[ :SENSe ] :IM:AVERAge:TCONtrol?**

Select the type of termination control used for averaging. This determines the averaging action after the specified number of data acquisitions (average count) is reached.



**EXPOnential** – Each successive data acquisition after the average count is reached, is exponentially weighted and combined with the existing average.

**REPeat** – After reaching the average count, the averaging is reset and a new average is started.

Factory Preset: REPeat

Remarks: You must be in the cdma2000, W-CDMA, or 1xEV-DO mode to use this command. Use INSTRUMENT:SElect to set the mode.

### Intermodulation—Integration Bandwidth

**[ :SENSE ] :IM:BANDwidth | BWIDth:INTEgration <freq>**

**[ :SENSE ] :IM:BANDwidth | BWIDth:INTEgration ?**

Set the Integration Bandwidth (IBW) that will be used.

Factory Preset: 1.23 MHz for cdma2000, 1xEV-DO  
3.84 MHz for W-CDMA

Range: 100.0 kHz to 5.0 MHz

Default Unit: Hz

Remarks: You must be in the cdma2000, W-CDMA, or 1xEV-DO mode to use this command. Use INSTRUMENT:SElect to set the mode.

### Intermodulation—Resolution Bandwidth

**[ :SENSE ] :IM:BANDwidth | BWIDth[:RESolution] <freq>**

**[ :SENSE ] :IM:BANDwidth | BWIDth[:RESolution] ?**

Set the resolution bandwidth that will be used for the Transmitter IM measurement mode. If span is set to a value greater than 5 MHz, minimum resolution bandwidth is limited to 1 kHz.

Factory Preset: Auto coupled.

Range: 100 Hz to 300.0 kHz

Default Unit: Hz

Remarks: You must be in the cdma2000, W-CDMA, or 1xEV-DO mode to use this command. Use INSTRUMENT:SElect to set the mode.

### Intermodulation—Resolution Bandwidth State

```
[ :SENSe ] :IM:BANDwidth | BWIDth [ :RESolution ] :AUTO OFF | ON | 0 | 1  
[ :SENSe ] :IM:BANDwidth | BWIDth [ :RESolution ] :AUTO?
```

Select auto (default value) or manual (user entered value) to set the resolution bandwidth.

Factory Preset: ON

Remarks: You must be in the cdma2000, W-CDMA, or 1xEV-DO mode to use this command. Use INSTRUMENT:SELEct to set the mode.

### Intermodulation—Base Frequency Auto Search

```
[ :SENSe ] :IM:FREQuency :AUTO OFF | ON | 0 | 1  
[ :SENSe ] :IM:FREQuency :AUTO?
```

Turn the base frequency auto search function on or off.

OFF – the frequencies set by the [ :SENSe ] :IM:FREQuency are used.

ON – automatically determined by searching the entire span.

Factory Preset: ON

Remarks: You must be in the cdma2000, W-CDMA, or 1xEV-DO mode to use this command. Use INSTRUMENT:SELEct to set the mode.

### Intermodulation—Base Frequencies Delta

```
[ :SENSe ] :IM:FREQuency [ :BASE ] :DELTA <freq>  
[ :SENSe ] :IM:FREQuency [ :BASE ] :DELTA?
```

Set the delta frequency which is (the base upper frequency – the base lower frequency).

Factory Preset: Auto coupled.

Range: E4406A  
–4.3214 GHz to 4.3214 GHz

PSA  
–3.0000 GHz to 3.0000 GHz

Default Unit: Hz

Remarks: Frequency step value is set by  
[ :SENSe ] :FREQuency :CENTer :STEP [ :INCRement ]  
You must be in the cdma2000, W-CDMA, or 1xEV-DO

mode to use this command. Use INSTRUMENT:SElect to set the mode.

### Intermodulation—Base Lower Frequency

**[ :SENSE ] :IM:FREQUENCY [ :BASE ] :LOWer <freq>**

**[ :SENSe ] :IM:FREQUENCY [ :BASE ] :LOWer?**

Set the frequency value of the base lower frequency. The available lower limit value is dependent on the Resolution Bandwidth setting.

Factory Preset: Auto coupled.

Range: E4406A  
1 kHz to 4.3214 GHz

PSA  
1 kHz to 3.0 GHz

Default Unit: Hz

Remarks: Frequency step value is set by  
**[ :SENSe ] :FREQUENCY:CENTer:STEP [ :INCRement ]**

You must be in the cdma2000, W-CDMA, or 1xEV-DO mode to use this command. Use INSTRUMENT:SElect to set the mode.

### Intermodulation—Base Upper Frequency

**[ :SENSE ] :IM:FREQUENCY [ :BASE ] :UPPER <freq>**

**[ :SENSe ] :IM:FREQUENCY [ :BASE ] :UPPER?**

Set the frequency value of the base upper frequency. The available lower limit value is dependent on the Resolution Bandwidth setting.

Factory Preset: Auto coupled.

Range: E4406A  
1 kHz to 4.3214 GHz

PSA  
1 kHz to 3.0 GHz

Default Unit: Hz

Remarks: Frequency step value is set by  
**[ :SENSe ] :FREQUENCY:CENTer:STEP [ :INCRement ]**

You must be in the cdma2000, W-CDMA, or 1xEV-DO mode to use this command. Use INSTRUMENT:SElect to set the mode.

### Intermodulation—Span

**[ :SENSe ] :IM:FREQuency:SPAN <freq>**

**[ :SENSe ] :IM:FREQuency:SPAN?**

Set the span.

Factory Preset: 20.0 MHz for cdma2000, 1xEV-DO

50.0 MHz for W-CDMA

Range: 100.0 kHz to 100.0 MHz

Default Unit: Hz

Remarks: You must be in the cdma2000, W-CDMA, or 1xEV-DO mode to use this command. Use INSTRument:SElect to set the mode.

### Intermodulation—Measurement Mode

**[ :SENSe ] :IM:MODE AUTO | TWOTone | TXIM**

**[ :SENSe ] :IM:MODE?**

Select the measurement mode of the intermodulation measurement.

AUTO – Automatically identifies the intermodulation caused by the two-tone or transmit intermodulation signals.

Two-tone (TWOTone)– Measures the two-tone intermodulation products.

Transmit (TXIM)– Measures the transmit intermodulation products.

Factory Preset: AUTO

Remarks: You must be in the cdma2000, W-CDMA, or 1xEV-DO mode to use this command. Use INSTRument:SElect to set the mode.

### Intermodulation—Measurement Reference

**[ :SENSe ] :IM:REFErence AUTO | AVERAge | LOWer | UPPer**

**[ :SENSe ] :IM:REFErence?**

Select the measurement reference of the intermodulation measurement.

AUTO – Automatically sets the highest level signal in two base signals as measurement reference.

AVERage – Sets the average level of the base lower carrier and upper carrier frequency as measurement reference.

LOWer – Sets the base lower carrier as measurement reference.

UPPer – Sets the base upper carrier as measurement reference.

Factory Preset: AUTO

Remarks: You must be in the cdma2000, W-CDMA, or 1xEV-DO mode to use this command. Use INSTRument:SElect to set the mode.

## Occupied Bandwidth Measurement

Commands for querying the occupied bandwidth measurement results and for setting to the default values are found in the “MEASure Group of Commands” on page 375. The equivalent front panel keys for the parameters described in the following commands, are found under the **Meas Setup** key, after the **Occupied BW** measurement has been selected from the **MEASURE** key menu.

### Occupied Bandwidth—Average Count

**[ :SENSe ] :OBW:AVERAge:COUNT <integer>**

**[ :SENSe ] :OBW:AVERAge:COUNT?**

Set the number of data acquisitions that will be averaged. After the specified number of average counts, the average mode (termination control) setting determines the average action.

Factory Preset: 10

Range: 1 to 10,000

Remarks: This command is used for measurements in the MEASURE menu.

You must be in the PDC, cdma2000, W-CDMA, or 1xEV-DO mode to use this command. Use INSTRument:SElect to set the mode.

History: E4406A:  
Version A.02.00 or later

Front Panel

Access: **Meas Setup, Avg Number**

### Occupied Bandwidth—Averaging State

**[ :SENSe ] :OBW:AVERAge [ :STATe ] OFF | ON | 0 | 1**

**[ :SENSe ] :OBW:AVERAge [ :STATe ] ?**

Turn the averaging function on or off.

Factory Preset: ON

Remarks: You must be in the PDC, cdma2000, W-CDMA, or 1xEV-DO mode to use this command. Use INSTRument:SElect to set the mode.

History: E4406A:  
Version A.02.00 or later

Front Panel

Access: **Meas Setup, Avg Number**

## Occupied Bandwidth—Averaging Termination Control

**[ :SENSe ] :OBW:AVERAge:TCOnTrol EXPOnential | REPEAT**

**[ :SENSe ] :OBW:AVERAge:TCOnTrol?**

Select the type of termination control used for the averaging function. This determines the averaging action after the specified number of data acquisitions (average count) is reached.

**EXPOnential** - After the average count is reached, each successive data acquisition is exponentially weighted and combined with the existing average.

**REPEAT** - After reaching the average count, the averaging is reset and a new average is started.

Factory Preset: EXPOnential for PDC

REPEAT for cdma2000, W-CDMA, 1xEV-DO

Remarks: You must be in the PDC, cdma2000, W-CDMA, or 1xEV-DO mode to use this command. Use INSTRument:SELEct to set the mode.

History: E4406A:  
Version A.02.00 or later

Front Panel

Access: Meas Setup, Avg Mode

## Occupied Bandwidth—Resolution Bandwidth

**[ :SENSe ] :OBW:BANDwidth | BWIDth [ :RESolution ] <freq>**

**[ :SENSe ] :OBW:BANDwidth | BWIDth [ :RESolution ]?**

Set the resolution bandwidth that will be used.

Factory Preset: 30.0 kHz

Range: 1.0 kHz to 1.0 MHz

Default Unit: Hz

Remarks: You must be in the cdma2000, W-CDMA, or 1xEV-DO mode to use this command. Use INSTRument:SELEct to set the mode.

## Occupied Bandwidth—FFT Window

**[ :SENSe ] :OBW:FFT:WINDow [ :TYPE ] BH4Tap | BLACkman | FLATtop**

| GAUSSian | HAMMING | HANNing | KB70 | KB90 | KB110 | UNIFORM

[ :SENSe ] :OBW:FFT:WINDow [ :TYPE ] ?

Select the FFT window type.

BH4Tap - Blackman Harris with 4 taps

BLACKman - Blackman

FLATtop - flat top, set to the default (for high amplitude accuracy)

GAUSSian - Gaussian with alpha of 3.5

HAMMING - Hamming

HANNing - Hanning

KB70, 90, and 110 - Kaiser Bessel with sidelobes at -70, -90, or -110 dBc

UNIFORM - no window is used. (This is the unity response.)

Factory Preset: GAUSSian

Remarks: You must be in the cdma2000, W-CDMA, or 1xEV-DO mode to use this command. Use INSTRUMENT:SElect to set the mode.

### Occupied Bandwidth—Span

[ :SENSe ] :OBW:FREQuency:SPAN <freq>

[ :SENSe ] :OBW:FREQuency:SPAN?

Set the occupied bandwidth span. The analyzer span will retain this value throughout the measurement.

Factory Preset: 10.0 MHz

3.75 MHz for cdma2000, 1xEV-DO

Range: 10.0 kHz to 10.0 MHz

Default Unit: Hz

Remarks: You must be in the PDC, cdma2000, W-CDMA, or 1xEV-DO mode to use this command. Use INSTRUMENT:SElect to set the mode.

### Occupied Bandwidth—Trigger Source

cdma2000, W-CDMA, 1xEV-DO mode

[ :SENSe ] :OBW:TRIGger:SOURce EXTERNAL [1] | EXTERNAL2 | FRAME | IF | IMMEDIATE | LINE | RFBURST



**[ :SENSe] :OBW:TRIGger:SOURce?**

Select one of the trigger sources used to control the data acquisitions for the occupied bandwidth measurement.

EXTernal1 – rear panel external trigger input

EXTernal2 – front panel external trigger input

FRAMe – internal frame trigger (cdma2000, W-CDMA, 1xEV-DO mode only)

IF – internal IF envelope (video) trigger

IMMediate – the next data acquisition is immediately taken, capturing the signal asynchronously (also called free run)

LINE – power line (cdma2000, W-CDMA, 1xEV-DO mode only)

RFBurst – wideband RF burst envelope trigger that has automatic level control for periodic burst signals

Factory Preset: IMMediate for BS in PDC, cdma2000, W-CDMA, 1xEV-DO mode

RFBurst for MS in PDC, iDEN (E4406A) mode

RFBurst for iDEN (E4406A)

Remarks:

You must be in the PDC, iDEN (E4406A), cdmaOne, cdma2000, W-CDMA, or 1xEV-DO mode to use this command. Use INSTRument:SElect to set the mode.

History:

E4406A:

Version A.02.00 or later

## RF Power Commands

### RF Port Input Attenuation

**[ :SENSe ] :POWer [ :RF ] :ATTenuation <rel\_power>**

**[ :SENSe ] :POWer [ :RF ] :ATTenuation?**

Set the RF input attenuator. This value is set at its auto value if RF input attenuation is set to auto.

Factory Preset: 0 dB

12 dB for iDEN (E4406A)

Range: 0 to 40 dB

Default Unit: dB

Front Panel

Access: **Input, Input Atten**

### Internal RF Preamplifier Control

**[ :SENSe ] :POWer [ :RF ] :GAIN [ :STATe ] OFF | ON | 0 | 1**

**[ :SENSe ] :POWer [ :RF ] :GAIN [ :STATe ] ?**

Turns the internal preamp on or off for the currently selected measurement. Requires Option 1DS.

Factory Preset: OFF

Front Panel

Access: **Input/Output, More (1 of 2), Int Preamp for Optional Personalities.**

AMPLITUDE/Y Scale, More (1 of 3), Int Preamp for SA mode

Remarks: For PSA you must be in W-CDMA, cdma2000, or 1xEV-DO mode to use this command. Use INSTRUMENT:SElect to set the mode. BEFORE you can turn on the preamp using the :SENSe command, you must also send the following command- :CONFigure:RHO | EVMQpsk | CDPower.

### Internal RF Preamplifier Attenuation

**[ :SENSe ] :POWer [ :RF ] :GAIN:ATTenuation <rel\_power>**

**[ :SENSe ] :POWer [ :RF ] :GAIN:ATTenuation?**

Specifies the internal mechanical attenuator setting when the internal preamp is on. Requires Option 1DS. This not the same attenuator used

when the preamp is OFF.

Factory Preset: 0 [dB]

Front Panel

Access: **Input/Output, More (1 of 2), Int Preamp for Optional Personalities.**  
AMPLITUDE/Y Scale, More (1 of 3), Int Preamp for SA mode

Range: 0,10, or 20 [dB]  
Other numbers between 0 and 20 are rounded to the nearest number; entries between numbers are rounded up. Entries above 20 are rounded down to 20.

Remarks: You must be in W-CDMA, cdma2000, or 1xEV-DO mode with the preamp ON to use this command. Use INSTRUMENT:SELEct to set the mode. BEFORE you can turn on the preamp using the :SENSe command, you must also send the following command- :CONFIgure:RHO | EVMQpsk | CDPower.

Key Path: Input/Output, More (1 of 2), Attenuation

State Saved: Saved in Instrument State

### RF Port Power Range Auto

**[ :SENSe ] :POWER [ :RF ] :RANGe :AUTO OFF | ON | 0 | 1**

**[ :SENSe ] :POWER [ :RF ] :RANGe :AUTO?**

Select the RF port power range to be set either automatically or manually.

ON - power range is automatically set as determined by the actual measured power level at the start of a measurement.

OFF - power range is manually set

Factory Preset: ON

Remarks: You must be in the cdmaOne, GSM, EDGE, NADC, PDC, cdma2000, W-CDMA, mode to use this command. Use INSTRUMENT:SELEct to set the mode.

Front Panel

Access: **Input, Max Total Pwr (at UUT)**

### RF Port Power Range Maximum Total Power

**[ :SENSe ] :POWER [ :RF ] :RANGe [ :UPPer ] <power>**

**[ :SENSe ] :POWer [ :RF ] :RANGe [ :UPPer ] ?**

Set the maximum expected total power level at the radio unit under test. This value is ignored if RF port power range is set to auto. External attenuation required above 30 dBm.

Factory Preset: -15.0 dBm

Range:           -100.0 to 80.0 dBm for EDGE, GSM  
                  -100.0 to 27.7 dBm for cdmaOne, iDEN (E4406A)  
                  -200.0 to 50.0 dBm for NADC, PDC  
                  -200.0 to 100.0 dBm for cdma2000, W-CDMA

Default Unit: dBm

Remarks:       Global to the current mode. This is coupled to the RF input attenuation

For E4406A you must be in the Service, cdmaOne, EDGE(w/GSM), GSM, iDEN, NADC, PDC, cdma2000, or W-CDMA mode to use this command. Use INSTRument:SElect to set the mode.

For PSA you must be in the cdmaOne, GSM, EDGE, NADC, PDC, cdma2000, or W-CDMA mode to use this command. Use INSTRument:SElect to set the mode.

Front Panel

Access:         **Input, Max Total Pwr (at UUT)**

## Power Statistics CCDF Measurement

Commands for querying the statistical power measurement of the complementary cumulative distribution function (CCDF) measurement results and for setting to the default values are found in the “[MEASure Group of Commands](#)” on page 375. The equivalent front panel keys for the parameters described in the following commands, are found under the **Meas Setup** key, after the **Power Stat CCDF** measurement has been selected from the **MEASURE** key menu.

History: E4406A:  
Added PStatistic to Basic Mode version A.04.00

### Power Statistics CCDF—Channel Bandwidth

**[ :SENSE ] :PStatistic: BANDwidth | BWIDth <freq>**

**[ :SENSE ] :PStatistic: BANDwidth | BWIDth?**

Enter a frequency value to set the channel bandwidth that will be used for data acquisition.

Factory Preset: 5.0 MHz

Range: 10.0 kHz to 6.7 MHz

Default Unit: Hz

Remarks: You must be in the Basic (E4406A), cdma2000, W-CDMA, or 1xEV-DO mode to use this command. Use INSTRUMENT:SELEct to set the mode.

### Power Statistics CCDF—Sample Counts

**[ :SENSE ] :PStatistic: COUNTs <integer>**

**[ :SENSE ] :PStatistic: COUNTs?**

Enter a value to set the sample counts. Measurement stops when the sample counts reach this value.

Factory Preset: 10,000,000

Range: 1,000 to 2,000,000,000

Unit: counts

Remarks: You must be in the Basic (E4406A), cdma2000, W-CDMA, or 1xEV-DO mode to use this command. Use INSTRUMENT:SELEct to set the mode.

### Power Statistics CCDF—Sweep Time

**[ :SENSE ] :PStatistic: SWEEp: TIME <time>**

**[ :SENSe ] :PStatistic:SWEEp:TIME?**

Enter a value to set the measurement interval that will be used to make measurements.

Factory Preset: 1.0 ms

Range: 0.1 ms to 10 ms

Remarks: You must be in the Basic, cdma2000, W-CDMA, or 1xEV-DO mode to use this command. Use INSTRument:SElect to set the mode.

### Power Statistics CCDF—Trigger Source

**[ :SENSe ] :PStatistic:TRIGger:SOURce**  
**EXTernal [1] | EXTernal2 | FRAME | IF | IMMEDIATE**  
**| RFBurst**

**[ :SENSe ] :PStatistic:TRIGger:SOURce?**

Select one of the trigger sources used to control the data acquisitions.

EXTernal 1 - front panel external trigger input

EXTernal 2 - rear panel external trigger input

FRAMe - uses the internal frame timer, which has been synchronized to the selected burst sync.

IF - internal IF envelope (video) trigger

IMMEDIATE - the next data acquisition is immediately taken, capturing the signal asynchronously (also called Free Run).

RFBurst - wideband RF burst envelope trigger that has automatic level control for periodic burst signals.

Factory Preset: IMMEDIATE

Remarks: You must be in the Basic (E4406A), cdma2000, W-CDMA, or 1xEV-DO mode to use this command. Use INSTRument:SElect to set the mode.

## Power vs. Time Measurement

Commands for querying the power versus time measurement results and for setting to the default values are found in the “MEASure Group of Commands” on page 375. The equivalent front panel keys for the parameters described in the following commands, are found under the **Meas Setup** key, after the **GMSK Pwr vs Time** measurement has been selected from the **MEASURE** key menu.

### Power vs. Time—Number of Bursts Averaged

**[ :SENSe ] :PVTime :AVERAge :COUNT <integer>**

**[ :SENSe ] :PVTime :AVERAge :COUNT ?**

Set the number of bursts that will be averaged. After the specified number of bursts (average counts), the averaging mode (terminal control) setting determines the averaging action.

Factory Preset: 15

100 for 1xEV-DO

Range: 1 to 10,000

Remarks: For E4406A you must be in the EDGE(w/GSM), GSM, 1xEV-DO, or Service mode to use this command. Use INSTRument:SElect to set the mode.

For PSA you must be in the GSM, EDGE, or 1xEV-DO mode to use this command. Use INSTRument:SElect to set the mode.

### Power vs. Time—Averaging State

**[ :SENSe ] :PVTime :AVERAge [ :STATe ] OFF | ON | 0 | 1**

**[ :SENSe ] :PVTime :AVERAge [ :STATe ] ?**

Turn averaging on or off.

Factory Preset: OFF

ON for 1xEV-DO, W-CDMA

Remarks: For E4406A you must be in the EDGE(w/GSM), GSM, 1xEV-DO, W-CDMA, or Service mode to use this command. Use INSTRument:SElect to set the mode.

For PSA you must be in the GSM, EDGE, 1xEV-DO, or W-CDMA mode to use this command. Use INSTRument:SElect to set the mode.

## Power vs. Time—Averaging Mode

**[ :SENSe ] :PVTime:AVERage:TCONtrol EXPonential|REPeat**

**[ :SENSe ] :PVTime:AVERage:TCONtrol?**

Select the type of termination control used for the averaging function. This specifies the averaging action after the specified number of bursts (average count) is reached.

EXPonential - Each successive data acquisition after the average count is reached is exponentially weighted and combined with the existing average.

REPeat - After reaching the average count, the averaging is reset and a new average is started.

Factory Preset: EXPonential

REPeat for 1xEV-DO, W-CDMA

Remarks: For E4406A you must be in the EDGE(w/GSM), GSM, 1xEV-DO, W-CDMA, or Service mode to use this command. Use INSTRument:SElect to set the mode.

For PSA you must be in the GSM, EDGE, 1xEV-DO or W-CDMA mode to use this command. Use INSTRument:SElect to set the mode.

## Power vs. Time—Averaging Type

EDGE (w/GSM), GSM, Service GSM, EDGE mode

**[ :SENSe ] :PVTime:AVERage:TYPE**

**LOG|MAXimum|MINimum|MXMinimum|RMS**

1xEV-DO mode

**[ :SENSe ] :PVTime:AVERage:TYPE**

**LOG|MAXimum|MINimum|MXMinimum|RMS|SCALar**

W-CDMA mode

**[ :SENSe ] :PVTime:AVERage:TYPE RMS|MAXimum|MINimum**

**[ :SENSe ] :PVTime:AVERage:TYPE?**

Select the type of averaging to be performed.

LOG - The log of the power is averaged. (This is also known as video averaging.)

MAXimum - The maximum values are retained.

MINimum - The minimum values are retained.

MXMinimum - Both the maximum and the minimum values are



retained. (E4406A - EDGE(W/GSM), GSM, and Service modes, and PSA - GSM, EDGE, and 1xEV-DO modes only)

RMS - The power is averaged to provide a voltage rms value.

SCALar - The amplitude level of power is averaged to provide a voltage value. (1xEV-DO mode only)

Factory Preset: RMS

Remarks: For E4406A you must be in the EDGE(w/GSM), GSM, 1xEV-DO, W-CDMA, or Service mode to use this command. Use INSTRument:SElect to set the mode.

For PSA you must be in the GSM, EDGE, 1xEV-DO, or W-CDMA mode to use this command. Use INSTRument:SElect to set the mode.

### Power vs. Time—Resolution BW

**[ :SENSe ] :PVTTime :BANDwidth | BWIDth [ :RESolution ] <freq>**

**[ :SENSe ] :PVTTime :BANDwidth | BWIDth [ :RESolution ] ?**

Set the resolution bandwidth. This is an advanced control that normally does not need to be changed. Setting this to a value other than the factory default, may cause invalid measurement results.

Factory Preset: 500 kHz 1.5 MHz

5.0 MHz for W-CDMA

Range: 1 kHz to 5 MHz

1.0 kHz to 10.0 MHz when PVT:BAND:RES:TYPE is set to FLATtop

1.0 kHz to 8.0 MHz when PVT:BAND:RES:TYPE is set to GAUSSian

Default Unit: Hz

Remarks: For E4406A you must be in the EDGE(w/GSM), GSM, Service, 1xEV-DO, or W-CDMA mode to use this command. Use INSTRument:SElect to set the mode.

For PSA you must be in the GSM, EDGE, 1xEV-DO, or W-CDMA mode to use this command. Use INSTRument:SElect to set the mode.

### Power vs. Time—RBW Filter Type

**[ :SENSe ] :PVTTime :BANDwidth | BWIDth [ :RESolution ] :TYPE  
FLATtop | GAUSSian**

**[[:SENSe]:PVTTime:BANDwidth|BWIDth[:RESolution]:TYPE?**

Select the type of resolution bandwidth filter. This is an advanced control that normally does not need to be changed. Setting this to a value other than the factory default, may cause invalid measurement results.

FLATtop - a filter with a flat amplitude response, which provides the best amplitude accuracy.

GAUSSian - a filter with Gaussian characteristics, which provides the best pulse response.

Factory Preset: GAUSSian

FLATtop for 1xEV-DO, W-CDMA

Remarks: For E4406A you must be in the EDGE(w/GSM), GSM, Service, 1xEV-DO, or W-CDMA mode to use this command. Use INSTRument:SElect to set the mode.

For PSA you must be in the GSM, EDGE, 1xEV-DO, or W-CDMA mode to use this command. Use INSTRument:SElect to set the mode.

### Power vs. Time—Burst Search Threshold

**[[:SENSe]:PVTTime:BURSt:STHreshold <rel\_power>**

**[[:SENSe]:PVTTime:BURSt:STHreshold?**

Specify the relative power threshold level to search for bursts. Use the commands SENSe:PVTTime:BURSt:SLOPe and SENe:PVTTime:BURSt:SLOPe:INTEgration:TIME with this command.

Factory Preset: -10.00 dB

-45 dB for W-CDMA

Range: -100 to 0 dB

Remarks: You must be in the 1xEV-DO or W-CDMA mode to use this command. Use INSTRument:SElect to set the mode.

History: PSA:  
Added in version A.02.00

E4406A:  
Added in version A.05.00

### Power vs. Time—Burst Search Slope

**[[:SENSe]:PVTTime:BURSt:SLOPe <number>**

**[ :SENSe] :PVTime:BURSt:SLOPe?**

Specify the minimum slope in the relative power level change per  $\mu\text{s}$ , to search for bursts at the specified threshold level.

Factory Preset: 2.0 dB/ $\mu\text{s}$

Range: 0.1 to 10.0 dB/ $\mu\text{s}$

Resolution: 0.1 dB/ $\mu\text{s}$

Remarks: You must be in the 1xEV-DO mode to use this command. Use INSTRument:SElect to set the mode.

History: PSA:  
Added in version A.02.00  
E4406A:  
Added in version A.05.00

**Power vs. Time—Burst Search Slope Time**

**[ :SENSe] :PVTime:BURSt:SLOPe:INTEgration:TIME <number>**

**[ :SENSe] :PVTime:BURSt:SLOPe:INTEgration:TIME?**

Specify the integration time in the number of chips, to calculate the minimum slope to search for bursts at the specified threshold level.

Factory Preset: 2.0 chip

Range: 0.5 to 3.0 chip

Resolution: 0.1 chip

Remarks: You must be in the 1xEV-DO mode to use this command. Use INSTRument:SElect to set the mode.

History: PSA:  
Added in version A.02.00  
E4406A:  
Added in version A.05.00

**Power vs. Time—Limit Mask Display**

**[ :SENSe] :PVTime:LIMit:MASK OFF|ON|0|1**

**[ :SENSe] :PVTime:LIMit:MASK?**

Show or hide the limit mask. Does not affect the pass/fail calculation for limit tests.

Factory Preset: ON

Remarks: You must be in GSM, EDGE, 1xEV-DO, or W-CDMA

mode to use this command. Use INSTRument:SElect to set the mode.

### Power vs. Time—Lower Active Slot Mask Relative Level

**[ :SENSe ] :PVTime:MASK:ASLot:LOWer:RELative <rel\_power>**

**[ :SENSe ] :PVTime:MASK:ASLot:LOWer:RELative?**

Enter the relative power level in the lower limit mask for the active slot.

Factory Preset: -2.5 dB

Range: -100 to +200 dB relative to the reference power

Default Unit: dB

Remarks: You must be in 1xEV-DO mode to use this command.  
Use INSTRument:SElect to set the mode.

History: PSA:  
Added in version A.02.00

E4406A:  
Added in version A.05.00

### Power vs. Time—Active Slot Mask Lower Limit Test Mode

**[ :SENSe ] :PVTime:MASK:ASLot:LOWer:TEST RELative|NONE**

**[ :SENSe ] :PVTime:MASK:ASLot:LOWer:TEST?**

Set the mask to the lower limit test mode relative to the reference power.

Factory Preset: RELative

Range: Only RELative is currently available for the active slot.

Remarks: You must be in 1xEV-DO mode to use this command.  
Use INSTRument:SElect to set the mode.

History: PSA:  
Added in version A.02.00

E4406A:  
Added in version A.05.00

### Power vs. Time—Active Slot Mask Time Interval

**[ :SENSe ] :PVTime:MASK:ASLot:SWEep:TIME <time>**

**[ :SENSE ] :PVTime:MASK:ASLot:SWEep:TIME?**

Define the time interval for active slot mask.

Factory Preset: 833.33  $\mu$ s

Range: -10 ms to +10 ms

Resolution: 10.0 ns

Remarks: You must be in 1xEV-DO mode to use this command.  
Use INSTRument:SElect to set the mode.

History: PSA:  
Added in version A.02.00  
  
E4406A:  
Added in version A.05.00

### Power vs. Time—Active Slot Mask Upper Limit Test Mode

**[ :SENSE ] :PVTime:MASK:ASLot:UPPer:TEST RELative|NONE**

**[ :SENSE ] :PVTime:MASK:ASLot:UPPer:TEST?**

Set the mask to the upper limit test mode relative to the reference power.

Factory Preset: RELative

Range: Only RELative is currently available for the active slot mask.

Remarks: You must be in 1xEV-DO mode to use this command.  
Use INSTRument:SElect to set the mode.

History: PSA:  
Added in version A.02.00  
  
E4406A:  
Added in version A.05.00

### Power vs. Time—Upper Active Slot Mask Relative Level

**[ :SENSE ] :PVTime:MASK:ASLot:UPPer:RELative <rel\_power>**

**[ :SENSE ] :PVTime:MASK:ASLot:UPPer:RELative?**

Enter the relative power level in the upper limit mask for the active slot.

Factory Preset: 2.5 dB

Range: -100 to +200 dB relative to the reference power

Default Unit: dB

Remarks: You must be in 1xEV-DO mode to use this command.  
Use INSTRument:SElect to set the mode.

History: PSA:  
Added in version A.02.00

E4406A:  
Added in version A.05.00

### Power vs. Time—Lower Mask Relative Amplitude Levels

```
[ :SENSe ] :PVTime:MASK:LIST:LOWer:RELative <rel_power>,  
<rel_power>, <rel_power>, <rel_power>
```

```
[ :SENSe ] :PVTime:MASK:LIST:LOWer:RELative?
```

Enter the relative power level for each horizontal line segment in the lower limit mask. There should be a power level for each time point entered using [ :SENSe ] :PVTime:MASK:LIST:LOWer:TIME, and they must be entered in the same order. These power levels are all relative to the defined Reference Power Level (the average power in the useful part of the data). When an upper and lower limit masks have been defined, the Reference Power Level is the mid-point between these two limits at time t0.

Any portion of the signal that has no limit line segment defined for it, will default to a very low limit (–100 dB relative to the reference power). This will keep the measurement from indicating a failure for that portion of the data.

Factory Preset: Selected GSM standard

–100.0, –100.0, –2.5, –100.0, and –100.0 dB for  
1xEV-DO

–100.0, –100.0, –1.0, –100.0, and –100.0 dB for  
W-CDMA

Range: –100.0 to 200 dB relative to the reference power

Default Unit: dB

Remarks: You must be in GSM, EDGE, 1xEV-DO, or W-CDMA  
mode to use this command. Use INSTRument:SElect to  
set the mode.

History: E4406A:  
Added in revision A.03.00

### Power vs. Time—Mask Lower Limit Test Mode

```
[ :SENSe ] :PVTime:MASK:LIST:LOWer:TEST RELative |NONE,
```

**,RELative|NONE, RELative|NONE, RELative|NONE, RELative|NONE**

**[ :SENSE ] :PVTime:MASK:LIST:LOWer:TEST?**

Set the mask to the lower limit test mode.

Factory Preset: NONE, NONE, RELative, NONE, NONE

Range: Only RELative is currently available.

Remarks: You must be in 1xEV-DO or W-CDMA mode to use this command. Use INSTRument:SElect to set the mode.

History: PSA:  
Added in version A.02.00  
  
E4406A:  
Added in version A.05.00

### Power vs. Time—Mask Power Reference

**[ :SENSE ] :PVTime:MASK:PREference A|B|C|D|E**

**[ :SENSE ] :PVTime:MASK:PREference?**

Select one of the regions to be used as the power reference. If a region is selected, the power in that region is computed and used as the reference power.

Factory Preset: C

Range: A, B, C, D, or E

Remarks: You must be in 1xEV-DO mode to use this command. Use INSTRument:SElect to set the mode.

History: PSA:  
Added in version A.02.00  
  
E4406A:  
Added in version A.05.00

### Power vs. Time—Mask Interval

**[ :SENSE ] :PVTime:MASK:LIST:SWEep:TIME <time>, <time>, <time>, <time>, <time>**

**[ :SENSE ] :PVTime:MASK:LIST:SWEep:TIME?**

Specify the time interval values of the limit mask.

Factory Preset: 319.34, 7.00, 180.66, 7.00, and 319.34  $\mu$ s

Range: -10 ms to +10 ms

Default Unit: seconds

Remarks: You must be in 1xEV-DO mode to use this command.  
Use INSTRument:SElect to set the mode.

History: PSA:  
Added in version A.02.00

E4406A:  
Added in version A.05.00

### Power vs. Time—Mask Time

```
[ :SENSe ] :PVTime:MASK:LIST:TIME <time>, <time>, <time>,  
<time>, <time>
```

```
[ :SENSe ] :PVTime:MASK:LIST:TIME?
```

Specify the starting time points of the limit mask.

Factory Preset: -416.67, -97.33, -90.33, 90.33, and 97.33  $\mu$ s

Range: -10 ms to +10 ms

Default Unit: seconds

Remarks: You must be in 1xEV-DO mode to use this command.  
Use INSTRument:SElect to set the mode.

History: PSA:  
Added in version A.02.00

E4406A:  
Added in version A.05.00

### Power vs. Time—Upper Mask Relative Amplitude Levels

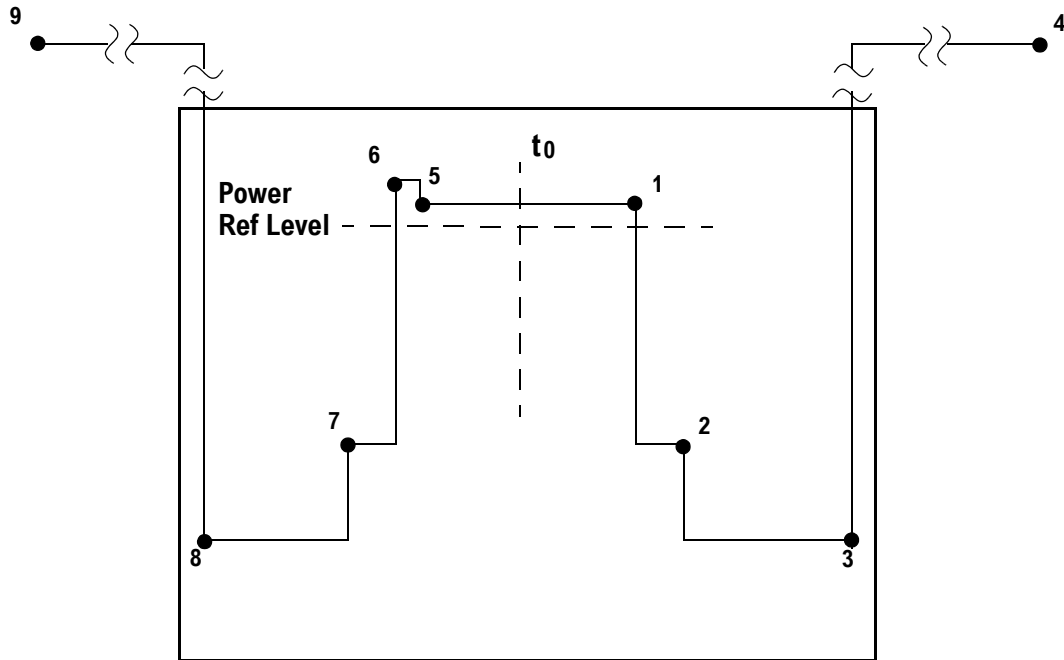
```
[ :SENSe ] :PVTime:MASK:LIST:UPPer:RElative <rel_power>,  
<rel_power>, <rel_power>, <rel_power>, <rel_power>
```

```
[ :SENSe ] :PVTime:MASK:LIST:UPPer:RElative?
```

Enter the relative power level for each horizontal line segment in the upper limit mask. There should be a power level for each time point entered using [ :SENSe ] :PVTime:MASK:LIST:UPPer:TIME, and they must be entered in the same order. These power levels are all relative to the defined Reference Power Level (the average power in the useful part of the data). When an upper and lower limit masks have been defined, the Reference Power Level is the mid-point between these two limits at time  $t_0$ . See [Figure 4-3 on page 481](#).



Figure 4-3 Custom Upper Limit Mask Example



Entered Value for each Time Segment	Absolute Time Value	Relative Power (example with Ref Level = -12 dBm)		Entered Absolute Power (dBm)	Segment Number
		Entered Relative Power	Equivalent Absolute Power		
280.0e-6	280 $\mu$ s	+4 dBc	-8 dBm	-200 dBm	1
15.0e-6	295 $\mu$ s	-32 dBc	-44 dBm	-200 dBm	2
450.0e-6	745 $\mu$ s	-48 dBc	-60 dBm <sup>a</sup>	-58 dBm <sup>a</sup>	3
1	>1 sec	+100 dBc	+112 dBm	-200 dBm	4
-270.0e-6	-270 $\mu$ s	+4 dBc	-8 dBm	-200 dBm	5
-10.0e-6	-280 $\mu$ s	+7 dBc	-5 dBm	-200 dBm	6
-20.0e-6	-300 $\mu$ s	-25 dBc	-37 dBm	-200 dBm	7
-450e-6	-750 $\mu$ s	-43 dBc	-55 dBm	-58 dBm	8
-1	<-1 sec	+100 dBc	+112 dBm	-200 dBm	9

a. Notice that this segment, with this value of Ref Level, has a calculated relative level of -60 dBm. This is lower than the specified absolute level of -58 dBm, so the -58 dBm value will be used as the test limit for the segment.

Example: **PVT:MASK:LIST:UPP:REL**

**4, -32, -48, 100, 4, 7, -25, -43, 100**

Factory Preset: Selected GSM standard

-7.0, 2.5, 2.5, 2.5, and 7.5 dB for 1xEV-DO

-40.0 dB, 2.0 dB, 1.0 dB, 2.0 dB, -40.0 dB for W-CDMA

Range: -100 to +200 dB relative to the reference power

Default Unit: dB

Remarks: You must be in GSM, EDGE, 1xEV-DO, or W-CDMA mode to use this command. Use INSTRument:SElect to set the mode.

History: E4406A:  
Added in revision A.03.00

### Power vs. Time—Mask Upper Limit Test Mode

**[ :SENSe ] :PVTime:MASK:LIST:UPPer:TEST RELative|NONE, RELative|NONE, RELative|NONE, RELative|NONE**

**[ :SENSe ] :PVTime:MASK:LIST:UPPer:TEST?**

Set to the upper limit test mode.

Factory Preset: RELative, RELative, RELative, RELative, RELative

Range: Only RELative is currently available.

Remarks: You must be in 1xEV-DO or W-CDMA mode to use this command. Use INSTRument:SElect to set the mode.

History: PSA:  
Added in version A.02.00  
  
E4406A:  
Added in version A.05.00

### Power vs. Time—Mask Reference Point

**[ :SENSe ] :PVTime:MASK:REFeRence TRIGger|RISE|CENTer**

**[ :SENSe ] :PVTime:MASK:REFeRence?**

Define the reference point of the mask timing.

TRIGger - Set to the trigger point.

RISE - Set to the rising edge of the burst determined after acquisition process.

CENTer - Set to the center between the rising and falling edges of the burst determined after acquisition process

Factory Preset: CENTER

RISE for W-CDMA

Remarks: You must be in 1xEV-DO or W-CDMA mode to use this command. Use INSTRUMENT:SELEct to set the mode.

History: PSA:  
Added in version A.02.00  
  
E4406A:  
Added in version A.05.00

### Power vs. Time—Mask Reference Point Offset

**[ :SENSE ] :PVTime:MASK:REFERENCE [ :OFFSet ] :TIME <time>**

**[ :SENSE ] :PVTime:MASK:REFERENCE [ :OFFSet ] :TIME?**

Define the time offset of the mask timing reference. This is an advanced control that normally does not need to be changed.

Factory Preset: 0 s

Range: -10 to +10 ms

Remarks: You must be in 1xEV-DO or W-CDMA mode to use this command. Use INSTRUMENT:SELEct to set the mode.

History: PSA:  
Added in version A.02.00  
  
E4406A:  
Added in version A.05.00

### Power vs. Time—Slot Type Selection

**[ :SENSE ] :PVTime:SLOT [ :TYPE ] IDLE | ACTIVE**

**[ :SENSE ] :PVTime:SLOT [ :TYPE ] ?**

Set the slot type to either Idle (including Pilot and MAC) or Active (including Pilot, MAC, and Data). Define the reference point of the mask timing.

IDLE - Set to the idle slot that includes the Pilot and MAC channels, of which waveform is bursted.

ACTIVE - Set to the active slot that includes the Pilot, MAC, and Data channels, of which signal is continuous.

Factory Preset: RISE

Remarks: You must be in 1xEV-DO mode to use this command. Use INSTRUMENT:SELEct to set the mode.

History:           PSA:  
                  Added in version A.02.00  
  
                  E4406A:  
                  Added in version A.05.00

### Power vs. Time—Trigger Source

```
[ :SENSe ] :PVTime:TRIGger:SOURce EXTernal [1] | EXTernal2  
| FRAMe | LINE | IF | IMMEDIATE | RFBURSt  
  
[ :SENSe ] :PVTime:TRIGger:SOURce?
```

Select the trigger source used to control the data acquisitions.

EXTernal 1 - front panel external trigger input

EXTernal 2 - rear panel external trigger input

FRAMe - uses the internal frame timer, which has been synchronized to the selected burst sync.

IF - internal IF envelope (video) trigger

LINE - internal power line frequency trigger

IMMEDIATE - the next data acquisition is immediately taken, capturing the signal asynchronously (also called Free Run).

RFBURSt - wideband RF burst envelope trigger that has automatic level control for periodic burst signals.

Factory Preset: RFBURSt if the RF Burst Hardware (option B7E) has been installed

EXTernal, if option B7E has not been installed

FRAMe for 1xEV-DO

Remarks:       For E4406A you must be in the EDGE(w/GSM), GSM, Service, 1xEV-DO, or W-CDMA mode to use this command. Use INSTRument:SElect to set the mode.

For PSA you must be in the GSM, EDGE, 1xEV-DO, or W-CDMA mode to use this command. Use INSTRument:SElect to set the mode.

## Radio Standards Commands

### Radio Carrier Multiple

**[ :SENSE ] :RADIO :CARRIER :NUMBER SINGLE | MULTIPLE**

**[ :SENSE ] :RADIO :CARRIER :NUMBER ?**

Select if single or multiple carriers are present on the output of the base station under test. This enables/disables a software filter for the rho and code domain power measurements.

SINGLE – disable software filter.

MULTIPLE – enable software filter to mitigate the adjacent carrier effects.

Factory Preset: SINGLE

Remarks: You must be in the cdmaOne, cdma2000, 1xEV-DO, or iDEN (E4406A) mode to use this command. Use INSTRUMENT:SELECT to set the mode.

Front Panel

Access: **Mode Setup, Demod, RF Carrier**

### Radio Device Under Test

**[ :SENSE ] :RADIO :DEVICE BTS | MS**

**[ :SENSE ] :RADIO :DEVICE ?**

Select the type of radio device to be tested.

BTS - Base station transmitter test

MS - Mobile station transmitter test

Factory Preset: BTS

Remarks: Global to the current mode.

You must be in cdma2000, GSM, EDGE, W-CDMA or 1xEV-DO mode to use this command. Use INSTRUMENT:SELECT to set the mode.

History: E4406A:  
Version A.03.00 or later

Front Panel

Access: **Mode Setup, Radio, Device**

## Physical Layer Reverse Link Subtype Selection

You can select the 1xEV-DO rev.A Physical Layer Subtype parameter for the signal under test, either Subtype 0 or Subtype 2, by remote SCPI command, as shown below.

For backward compatibility with 1xEV-DO rev.0 the Subtype 0 selection is compatible with Subtype 1 signals.

Subtype parameter selection by menu key is detailed in the Key Reference chapter of the 1xEV-DO Guide.

Mode	1xEVDO
<b>Remote Command</b>	<b>[ :SENSe ] :RADio:PLSubtype SUB0 SUB2</b> <b>[ :SENSe ] :RADio:PLSubtype?</b>
Example	:RAD:PLSubtype SUB2
Preset	SUB0
State Saved	Saved in instrument state.
Key Path	<b>Mode Setup, Demod, Physical Layer Subtype selection RUI Operation</b>
History	Newly added from A.08.XX (PSA) and A.09.XX (E4406A)

## Modulation Accuracy (Rho) Measurement

Commands for querying the rho measurement results and for setting to the default values are found in the “MEASure Group of Commands” on page 375. The equivalent front panel keys for the parameters described in the following commands, are found under the **Meas Setup** key, after the **Mod Accuracy (Rho)** or **Mod Accuracy (Composite Rho)** measurement has been selected from the **MEASURE** key menu.

### Modulation Accuracy – Active Data Channel

```
[ :SENSe ] :RHO:ACODE AUTO|PREDeFined
```

```
[ :SENSe ] :RHO:ACODE?
```

Select the Active Channel ID detection mode Auto or Predefined.

AUTO - detects Active Channel ID for Data Channel automatically.

PREDeFined - set predefined Active Channel (all channel codes) for Data Channel.

Factory Preset: AUTO

Remarks: You must be in the 1xEV-DO mode to use this command. Use INSTRument:SElect to set the mode.

### Modulation Accuracy (Rho) Measurement — ADC Range

```
[ :SENSe ] :RHO:ADC:RANGe
```

```
AUTO|APEak|APLock|NONE|M6|P0|P6|P12|P18|P24
```

```
[ :SENSe ] :RHO:ADC:RANGe?
```

Select a ranging function for the ADC gain control. This is an advanced control that normally does not need to be changed. If you are measuring a CW signal, see the following description:

- AUTO - automatic ranging

For FFT spectrums, the auto ranging should not be used. An exception to this would be if you know that your signal is “bursty”. Then you might use auto to maximize the time domain dynamic range as long as you are not very interested in the FFT data.

- APEak (Auto Peak) - automatic ranging to the peak signal level

For CW signals, the default of auto-peak ranging can be used, but a better FFT measurement of the signal can be made by selecting one of the manual ranges that is available by specifying M6, or P0 through P24.

Auto peaking can cause the ADC gain to monotonically track the ranges down during the data capture. This tracking effect should be negligible for the FFT spectrum, but selecting a manual range solves

this possibility. Note that if the CW signal being measured is close to the auto-ranging threshold, the noise floor may shift as much as 6 dB every sweep.

- APLOCK (Auto Peak Lock) - automatic ranging locked to the peak signal level

For CW signals, auto-peak lock ranging may be used. It will find the ADC gain most appropriate for this particular signal and will not track the ranges as auto-peak can. Note that if the CW signal being measured is close to the auto-ranging threshold, the noise floor may shift as much as 6 dB every sweep.

For “bursty” signals, auto-peak lock ranging should not be used. Since the ADC range can often be locked to the wrong one resulting in overloading the ADC, the measurement will fail.

- NONE - turns off any auto-ranging without making any changes to the current setting.
- M6 - manually selects an ADC range that subtracts 6 dB from the fixed gain across the range. Manual ranging is best for CW signals.
- P0 thru P24 - manually selects one of the ADC ranges that add 0 dB to 24 dB to the fixed gain across the range. Manual ranging is best for CW signals.

Factory Preset: M6

Remarks: You must be in the 1xEV-DO mode to use this command. Use INSTRUMENT:SElect to set the mode.

### Modulation Accuracy (Rho)—Average Count

**[ :SENSe ] :RHO:AVERAge:COUNT <integer>**

**[ :SENSe ] :RHO:AVERAge:COUNT?**

Set the number of data acquisitions that will be averaged. After the specified number of averaging counts, the averaging mode (termination control) setting determines the averaging action.

Factory Preset: 10

Range: 1 to 10,000

Remarks: You must be in the cdmaOne, cdma2000, W-CDMA, or 1xEV-DO mode to use this command. Use INSTRUMENT:SElect to set the mode.

### Modulation Accuracy (Rho)—Averaging State

**[ :SENSe ] :RHO:AVERAge [ :STATe ] OFF | ON | 0 | 1**



**[ :SENSe] :RHO:AVERAge [ :STAtE] ?**

Turn the modulation accuracy averaging function on or off.

Factory Preset: OFF

ON for cdma2000, W-CDMA, 1xEV-DO

Remarks: You must be in the cdmaOne, cdma2000, W-CDMA, or 1xEV-DO mode to use this command. Use INSTRument:SELEct to set the mode.

### Modulation Accuracy (Rho)—Averaging Termination Control

**[ :SENSe] :RHO:AVERAge:TCONtrol EXPOnential|REPeat**

**[ :SENSe] :RHO:AVERAge:TCONtrol?**

Select the type of termination control used for the averaging function. This determines the averaging action after the specified number of frames (average count) is reached.

EXPOnential - Each successive data acquisition after the average count is reached, is exponentially weighted and combined with the existing average.

REPeat - After reaching the average count, the averaging is reset and a new average is started.

Factory Preset: REPeat for cdmaOne, cdma2000, W-CDMA, 1xEV-DO

Remarks: You must be in the cdmaOne, cdma2000, W-CDMA, or 1xEV-DO mode to use this command. Use INSTRument:SELEct to set the mode.

### Modulation Accuracy (Rho)—Chip Rate

**[ :SENSe] :RHO:CRATe <freq>**

**[ :SENSe] :RHO:CRATe?**

Enter a frequency value to set the chip rate.

Factory Preset: 1.2288 MHz for cdma2000, 1xEV-DO

3.84 MHz for W-CDMA

Range: 1.10592 to 1.35168 MHz for cdma2000, 1xEV-DO

3.456 to 4.224 MHz for W-CDMA

Default Unit: Hz

Remarks: You must be in the cdma2000, W-CDMA, or 1xEV-DO

mode to use this command. Use INSTRument:SElect to set the mode.

### Modulation Accuracy (Rho)—Multi Carrier Estimator

**[ :SENSe ] :RHO:MCEstimator OFF|ON|0|1**

**[ :SENSe ] :RHO:MCEstimator?**

Turns the multi carrier estimator on or off.

OFF - computes the phase information only from one coded signal assuming that each code phase is perfectly aligned.

ON - aligns the code phases to be orthogonal before computing the phase information.

Factory Preset: OFF

Remarks: You must be in the cdma2000, W-CDMA, or 1xEV-DO mode to use this command. Use INSTRument:SElect to set the mode.

### Modulation Accuracy (Rho)—PN Offset

**[ :SENSe ] :RHO:PNOffset <integer>**

**[ :SENSe ] :RHO:PNOffset?**

Set a PN sequence number for the base station being tested. This value behaves as a multiplier for the Walsh codes of which length is in the unit of 64 chips.

Factory Preset: 0

Range: 0 to 511

Unit: 64 chips

Remarks: You must be in the 1xEV-DO mode to use this command. Use INSTRument:SElect to set the mode.

### Modulation Accuracy (Rho)—Preamble Length

**[ :SENSe ] :RHO:PREamble:LENGth <integer>**

**[ :SENSe ] :RHO:PREamble:LENGth?**

Set the Preamble length manually in chips.

Factory Preset: 0

Range: 0, 64, 128, 256, 512 and 1024

Remarks: You must be in the 1xEV-DO mode to use this command. Use INSTRUMENT:SElect to set the mode.

### Modulation Accuracy (Rho)—Preamble Auto Detection

**[ :SENSE ] :RHO:PREamble:LENGth:AUTO OFF | ON | 0 | 1**

**[ :SENSE ] :RHO:PREamble:LENGth:AUTO?**

Turn the Preamble Length detection mode on or off.

On - detects the Preamble length automatically.

Off - sets the Preamble length manually by  
[:SENSE]:RHO:PREamble:LENGth.

Factory Preset: ON

Remarks: You must be in the 1xEV-DO mode to use this command. Use INSTRUMENT:SElect to set the mode.

### Modulation Accuracy (Rho)—Rho Overall Preamble Included

**[ :SENSE ] :RHO:PREamble:STATE OFF | ON | 0 | 1**

**[ :SENSE ] :RHO:PREamble:STATE?**

Select whether or not Preamble is included for Rho Overall calculation.

On – Preamble chips is included for Rho Overall calculation

Off – Preamble chips is Not included for Rho Overall calculation.

Factory Preset: ON

Remarks: You must be in the 1xEV-DO mode to use this command. Use INSTRUMENT:SElect to set the mode.

### Modulation Accuracy (Rho)—Spectrum Normal/Invert

**[ :SENSE ] :RHO:SPECTrum INVert | NORMAl**

**[ :SENSE ] :RHO:SPECTrum?**

Set a spectrum either to normal or inverted for the demodulation related measurements. If set to INVert, the upper and lower spectrums are swapped.

Factory Preset: NORMAl

Remarks You must be in the cdmaOne, cdma2000, W-CDMA, or 1xEV-DO mode to use this command. Use INSTRUMENT:SElect to set the mode.

## Modulation Accuracy (Rho)—Trigger Source

```
[ :SENSe ] :RHO:TRIGger:SOURce  
EXTernal [1] | EXternal2 | FRAMe | IF | IMMEDIATE | RFBurst
```

```
[ :SENSe ] :RHO:TRIGger:SOURce?
```

Select the trigger source used to control the data acquisitions.

EXTernal 1 – front panel external trigger input

EXTernal 2 – rear panel external trigger input

FRAMe – internal frame trigger

IF – internal IF envelope (video) trigger

IMMEDIATE – the next data acquisition is immediately taken, capturing the signal asynchronously (also called free run).

RFBurst – internal wideband RF burst envelope trigger that has automatic level control for periodic burst signals.

Factory Preset: IMMEDIATE

Remarks: You must be in the cdmaOne, cdma2000, W-CDMA, or 1xEV-DO mode to use this command. Use INSTRUMENT:SElect to set the mode.

Front Panel

Access: Meas Setup, Trig Source

## Spectrum Emission Mask Measurement

Commands for querying the Spectrum Emission Mask measurement results and for setting to the default values are found in the “[MEASure Group of Commands](#)” on page 375. The equivalent front panel keys for the parameters described in the following commands, are found under the **Meas Setup** key, after selecting the measurement from the **MEASURE** key menu. Select the **Spectrum Emission Mask** measurement (for W-CDMA, cdma2000) or the **Spurious Emissions and ACP** measurement (for 1xEV-DO).

History: E4406A:  
Added version A.04.00 and later

### Spectrum Emission Mask—Average Count

**[ :SENSe ] :SEMAsk:AVERAge:COUNT <integer>**

**[ :SENSe ] :SEMAsk:AVERAge:COUNT?**

Set the number of data acquisitions that will be averaged. After the specified number of average count, the average mode (termination control) setting determines the average action.

Factory Preset: 10

Range: 1 to 10,000

Remarks: You must be in the cdma2000, W-CDMA, or 1xEV-DO mode to use this command. Use INSTRument:SElect to set the mode.

### Spectrum Emission Mask—Averaging State

**[ :SENSe ] :SEMAsk:AVERAge [ :STATe ] OFF | ON | 0 | 1**

**[ :SENSe ] :SEMAsk:AVERAge [ :STATe ] ?**

Turn the averaging function On or Off.

Factory Preset: OFF

Remarks: You must be in the cdma2000, W-CDMA, or 1xEV-DO mode to use this command. Use INSTRument:SElect to set the mode.

### Spectrum Emission Mask—Averaging Termination Control

**[ :SENSe ] :SEMAsk:AVERAge:TCONtrol EXPonential | REPeat**

**[ :SENSe ] :SEMAsk:AVERAge:TCONtrol?**

Select the type of termination control used for averaging. This

determines the averaging action after the specified number of data acquisitions (average count) is reached.

EXPonential - Each successive data acquisitions after the average count is reached is exponentially weighted and combined with the existing average.

REPeat - After reaching the average count, the averaging is reset and a new average is started.

Factory Preset: EXPonential

Remarks: You must be in the 1xEV-DO mode to use this command. Use INSTRument:SElect to set the mode.

### Spectrum Emission Mask—Reference Channel Integration Bandwidth

cdma2000, W-CDMA mode

```
[ :SENSE ] :SEMAsk :BANDwidth[n] | BWIDth[n] :INTegration <freq>
```

```
[ :SENSE ] :SEMAsk :BANDwidth[n] | BWIDth[n] :INTegration?
```

1xEV-DO mode

```
[ :SENSE ] :SEMAsk :BANDwidth | BWIDth :INTegration[m] <freq>
```

```
[ :SENSE ] :SEMAsk :BANDwidth | BWIDth :INTegration[m] ?
```

Set the integration bandwidth that will be used for the reference channel.

BANDwidth[n] | BWIDth[n]

n=1 is the base station test and n=2 is the mobile station test. The default is the base station test (1). (cdma2000, W-CDMA mode only)

INTegration[m] m=1 is the spectrum emission mask (SEM) mode and m=2 is the adjacent channel power (ACP) mode. The default is the SEM mode (1). (1xEV-DO mode only)

Factory Preset: 1.23 MHz for cdma2000, 1xEV-DO

3.84 MHz for W-CDMA

Range: 100.0 kHz to 1.250 MHz

Default Unit: Hz

Remarks: You must be in the cdma2000, W-CDMA, or 1xEV-DO mode to use this command. Use INSTRument:SElect to set the mode.

## Spectrum Emission Mask—Reference Channel Resolution Bandwidth

cdma2000, W-CDMA mode

**[ :SENSE ] :SEMAsk :BANDwidth [ n ] | BWIDth [ n ] :RESolution <freq>**

**[ :SENSe ] :SEMAsk :BANDwidth [ n ] | BWIDth [ n ] :RESolution?**

1xEV-DO mode

**[ :SENSe ] :SEMAsk :BANDwidth | BWIDth :RESolution [ m ] <freq>**

**[ :SENSe ] :SEMAsk :BANDwidth | BWIDth :RESolution [ m ] ?**

Set the resolution bandwidth for the reference channel.

**BANDwidth [ n ] | BWIDth [ n ]**

n=1 is the base station test and n=2 is the mobile station test. The default is the base station test (1). (cdma2000, W-CDMA mode only)

**RESolution [ m ]** m=1 is the spectrum emission mask (SEM) mode and m=2 is the adjacent channel power (ACP) mode. The default is the SEM mode (1). (1xEV-DO mode only)

**Factory Preset:** No valid value as the default is set to Auto. See [ :SENS ] :SEM :BAND [ n ] | BWID [ n ] :RES [ m ] :AUTO.

**Range:** 1.0 kHz to 7.5 MHz

**Default Unit:** Hz

**Remarks:** You must be in the cdma2000, W-CDMA, or 1xEV-DO mode to use this command. Use INSTRument :SElect to set the mode.

## Spectrum Emission Mask—Auto Mode for Reference Channel Resolution Bandwidth

cdma2000, W-CDMA mode

**[ :SENSE ] :SEMAsk :BANDwidth [ n ] | BWIDth [ n ] :RESolution :AUTO OFF | ON | 0 | 1**

**[ :SENSe ] :SEMAsk :BANDwidth [ n ] | BWIDth [ n ] :RESolution :AUTO?**

1xEV-DO mode

**[ :SENSe ] :SEMAsk :BANDwidth | BWIDth :RESolution [ m ] :AUTO OFF | ON | 0 | 1**

**[ :SENSe ] :SEMAsk :BANDwidth | BWIDth :RESolution [ m ] :AUTO?**

Set the auto mode to determine the resolution bandwidth to On or Off. If set to Off, enter a frequency value referring to [ :SENS ] :SEM :BAND [ n ] | BWID [ n ] :RES [ m ].

BANDwidth[n] | BWIDth[n]

n=1 is the base station test and n=2 is the mobile station test. The default is the base station test (1). (cdma2000, W-CDMA mode only)

RESolution[m] m=1 is the spectrum emission mask (SEM) mode and m=2 is the adjacent channel power (ACP) mode. The default is the SEM mode (1). (1xEV-DO mode only)

Factory Preset: ON

Remarks: You must be in the cdma2000, W-CDMA, or 1xEV-DO mode to use this command. Use INSTRUMENT:SElect to set the mode.

### Spectrum Emission Mask—Detector Mode

[ :SENSe ] :SEMAsk:DETEctor[:FUNction] AAVerage | POSitive

[ :SENSe ] :SEMAsk:DETEctor[:FUNction] ?

Select one of the detector modes for spectrum measurements.

AAVerage (absolute average) - the absolute average power in each frequency is measured across the spectrum

POSitive - the positive peak power in each frequency is measured across the spectrum

Factory Preset: AAVerage (absolute average)

Remarks: You must be in the cdma2000, W-CDMA, or 1xEV-DO mode to use this command. Use INSTRUMENT:SElect to set the mode.

### Spectrum Emission Mask—Channel Frequency Span

[ :SENSe ] :SEMAsk:FREQuency[n] :SPAN[m] <freq>

[ :SENSe ] :SEMAsk:FREQuency[n] :SPAN[m] ?

Enter a frequency value to set the channel frequency span for the reference channel integration.

FREQuency[n] n=1 is the base station test and n=2 is the mobile test. The default is the base station test (1). (cdma2000, W-CDMA mode only)

SPAN[m] m=1 is the spectrum emission mask (SEM) mode and m=2 is the adjacent channel power (ACP) mode. The default is the SEM mode (1). (1xEV-DO mode only)

Factory Preset: 1.25 MHz for cdma2000, 1xEV-DO



5.0 MHz for W-CDMA

Range: 100.0 kHz to 10.0 MHz

Remarks: You must be in the cdma2000, W-CDMA, or 1xEV-DO mode to use this command. Use INSTRument:SElect to set the mode.

### Spectrum Emission Mask—Reference Channel Step Frequency

cdma2000, W-CDMA mode

**[ :SENSe ] :SEMAsk:FREQuency [n] :STEP <freq>**

**[ :SENSe ] :SEMAsk:FREQuency [n] :STEP?**

1xEV-DO mode

**[ :SENSe ] :SEMAsk:FREQuency:STEP [m] <freq>**

**[ :SENSe ] :SEMAsk:FREQuency:STEP [m] ?**

Enter a frequency value to set the step frequency for the reference channel integration.

**FREQuency[n]** n=1 is the base station test and n=2 is the mobile test. The default is the base station test (1). (cdma2000, W-CDMA mode only)

**STEP[m]** m=1 is the spectrum emission mask (SEM) mode and m=2 is the adjacent channel power (ACP) mode. The default is the SEM mode (1). (1xEV-DO mode only)

**Factory Preset:** No valid value as the default is set to Auto. See [:SENS]:SEM:FREQ[n]:STEP[m]:AUTO.

Range: 100 Hz to 7.5 MHz

Remarks: You must be in the cdma2000, W-CDMA, or 1xEV-DO mode to use this command. Use INSTRument:SElect to set the mode.

### Spectrum Emission Mask—Auto Mode for Reference Channel Step Frequency

cdma2000, W-CDMA mode

**[ :SENSe ] :SEMAsk:FREQuency [n] :STEP:AUTO OFF | ON | 0 | 1**

**[ :SENSe ] :SEMAsk:FREQuency [n] :STEP:AUTO?**

1xEV-DO mode

**[ :SENSe ] :SEMAsk:FREQuency:STEP [m] :AUTO OFF | ON | 0 | 1**

**[ :SENSe ] :SEMask:FREQuency:STEP [m] :AUTO?**

Set the auto mode to determine the step frequency to On or Off.

OFF - enter a value to set the step frequency for the reference channel integration, referring to [:SENS]:SEM:FREQ[n]:STEP[m].

ON - the step frequency for the reference channel integration is set to a half of the resolution bandwidth.

FREQuency[n] n=1 is the base station test and n=2 is the mobile test. The default is the base station test (1). (cdma2000, W-CDMA mode only)

STEP[m] m=1 is the spectrum emission mask (SEM) mode and m=2 is the adjacent channel power (ACP) mode. The default is the SEM mode (1). (1xEV-DO mode only)

Factory Preset: ON

Remarks: You must be in the cdma2000, W-CDMA, or 1xEV-DO mode to use this command. Use INSTRument:SElect to set the mode.

## Spectrum Emission Mask—Offset Resolution Bandwidth

cdma2000, W-CDMA mode

**[ :SENSe ] :SEMask:OFFSet [n] :LIST:BA NDwidth | BWIDTh  
<res\_bw>, <res\_bw>, <res\_bw>, <res\_bw>, <res\_bw>**

**[ :SENSe ] :SEMask:OFFSet [n] :LIST:BA NDwidth | BWIDTh?**

1xEV-DO mode

**[ :SENSe ] :SEMask:OFFSet:LIST [m] :BA NDwidth | BWIDTh  
<res\_bw>, <res\_bw>, <res\_bw>, <res\_bw>, <res\_bw>**

**[ :SENSe ] :SEMask:OFFSet:LIST [m] :BA NDwidth | BWIDTh?**

Define the offset resolution bandwidth for Spectrum Emission Mask measurements. The list must contain five (5) entries. You can turn off (not use) specific offsets with [:SENS]:SEM:OFFS[n]:LIST[m]:STAT.

OFFSet[n] n=1 is the base station test and n=2 is the mobile test. The default is the base station test (1). (cdma2000, W-CDMA only)

LIST[m] m=1 is the spectrum emission mask (SEM) mode and m=2 is the adjacent channel power (ACP) mode. The default is the SEM mode (1). (1xEV-DO mode only)

Factory Preset:

Mode	Variant	Offset A	Offset B	Offset C	Offset D	Offset E
cdma2000	BTS	3.00 kHz	30.00 kHz	30.0 kHz	6.25 kHz	1.000 MHz
	MS	30.00 kHz	30.00 kHz	6.25 kHz	1.000 MHz	1.000 MHz
W-CDMA	BTS	30.00 kHz	30.00 kHz	30.00 kHz	50.00 kHz	1.000 MHz
	MS	30.00 kHz	1.000 MHz	1.000 MHz	1.000 MHz	1.000 MHz
1xEV-DO	SEM	3.000 kHz	30.00 kHz	30.00 kHz	6.250 kHz	1.000 MHz
	ACP	3.000 kHz	30.00 kHz	30.00 kHz	30.00 kHz	30.00 kHz

Range: 300 Hz to 7.5 MHz

Default Unit: Hz

Remarks: You must be in the cdma2000, W-CDMA, or 1xEV-DO mode to use this command. Use INSTRument:SElect to set the mode.

### Spectrum Emission Mask—Auto Offset Resolution Bandwidth

cdma2000, W-CDMA mode

```
[ :SENSe] :SEMAsk:OFFSet [n] :LIST:BANdwidth|BWIDth:AUTO  
OFF|ON|0|1,OFF|ON|0|1,OFF|ON|0|1,OFF|ON|0|1,OFF|ON|0|1
```

```
[ :SENSe] :SEMAsk:OFFSet [n] :LIST:BANdwidth|BWIDth:AUTO?
```

1xEV-DO mode

```
[ :SENSe] :SEMAsk:OFFSet:LIST[m]:BANdwidth|BWIDth:AUTO  
OFF|ON|0|1,OFF|ON|0|1,OFF|ON|0|1,OFF|ON|0|1,OFF|ON|0|1
```

```
[ :SENSe] :SEMAsk:OFFSet:LIST[m]:BANdwidth|BWIDth:AUTO?
```

Set the auto mode to determine the offset resolution bandwidth to On or Off.

OFF - enter a value to set the resolution bandwidth for an offset channel, referring to [:SENS]:SEM:OFFS[n]:LIST[m]BAND|BWID.

ON - the resolution bandwidth for an offset channel is automatically set according to the offset start and stop frequencies.

OFFSet[n] n=1 is the base station test and n=2 is the mobile test. The default is the base station test (1). (cdma2000, W-CDMA mode only)

LIST[m] m=1 is the spectrum emission mask (SEM) mode and m=2 is the adjacent channel power (ACP) mode. The default is the SEM mode (1). (1xEV-DO mode only)

Factory Preset and \*RST:

Mode	Variant	Offset A	Offset B	Offset C	Offset D	Offset E
cdma2000		OFF	OFF	OFF	OFF	OFF
W-CDMA		OFF	OFF	OFF	OFF	OFF
1xEV-DO	SEM	OFF	OFF	OFF	OFF	OFF
	ACP	OFF	OFF	OFF	OFF	OFF

Remarks: You must be in the cdma2000, W-CDMA, or 1xEV-DO mode to use this command. Use INSTRument:SElect to set the mode.

### Spectrum Emission Mask—Offset Resolution Bandwidth Multiplier

cdma2000, W-CDMA mode

```
[ :SENSe ] :SEMAsk:OFFSet [n] :LIST:BAWdth|BWiDth:IMULti
<integer>, <integer>, <integer>, <integer>, <integer>
```

```
[ :SENSe ] :SEMAsk:OFFSet [n] :LIST:BAWdth|BWiDth:IMULti?
```

1xEV-DO mode

```
[ :SENSe ] :SEMAsk:OFFSet:LIST[m] :BAWdth|BWiDth:IMULti
<integer>, <integer>, <integer>, <integer>, <integer>
```

```
[ :SENSe ] :SEMAsk:OFFSet:LIST[m] :BAWdth|BWiDth:IMULti?
```

Specify a multiplier of the offset resolution bandwidth for the offset measurement integration bandwidth.

OFFSet[n] n=1 is the base station test and n=2 is the mobile test. The default is the base station test (1). (cdma2000, W-CDMA mode only)

LIST[m] m=1 is the spectrum emission mask (SEM) mode and m=2 is the adjacent channel power (ACP) mode. The default is the SEM mode (1). (1xEV-DO mode only)

Factory Preset:

Mode	Variant	Offset A	Offset B	Offset C	Offset D	Offset E
cdma2000	BTS	10	1	1	1	1
	MS	1	1	1	1	1
W-CDMA	BTS	1	1	1	20	1
	MS	1	1	1	1	1

Mode	Variant	Offset A	Offset B	Offset C	Offset D	Offset E
1xEV-DO	SEM	10	1	1	1	1
	ACP	10	1	1	1	1

Range: 1 to ((Stop frequency – Start frequency) / Resolution bandwidth)

Remarks: You must be in the cdma2000, W-CDMA, or 1xEV-DO mode to use this command. Use INSTRument:SElect to set the mode.

### Spectrum Emission Mask—Offset Start Frequency

cdma2000, W-CDMA mode

```
[ :SENSe] :SEMAsk:OFFSet [n] :LIST:FREQuency:START
<f_offset>, <f_offset>, <f_offset>, <f_offset>, <f_offset>
```

```
[ :SENSe] :SEMAsk:OFFSet [n] :LIST:FREQuency:START?
```

1xEV-DO mode

```
[ :SENSe] :SEMAsk:OFFSet:LIST [m] :FREQuency:START
<f_offset>, <f_offset>, <f_offset>, <f_offset>, <f_offset>
```

```
[ :SENSe] :SEMAsk:OFFSet:LIST [m] :FREQuency:START?
```

Set the five (5) sets of the offset start frequencies.

OFFSet[n] n=1 is the base station test and n=2 is the mobile test. The default is the base station test (1). (cdma2000, W-CDMA mode only)

LIST[m] m=1 is the spectrum emission mask (SEM) mode and m=2 is the adjacent channel power (ACP) mode. The default is the SEM mode (1). (1xEV-DO mode only)

Factory Preset:

Mode	Variant	Offset A	Offset B	Offset C	Offset D	Offset E
cdma2000	BTS	765.0 kHz	795.0 kHz	1.195 MHz	3.2531 MHz	7.500 MHz
	MS	900.0 kHz	1.995 MHz	2.2531 MHz	8.500 MHz	12.50 MHz
W-CDMA	BTS	2.515 MHz	2.715 MHz	3.515 MHz	4.000 MHz	8.000 MHz
	MS	2.515 MHz	4.000 MHz	7.500 MHz	8.5 00MHz	12.50 MHz
1xEV-DO	SEM	765.0 kHz	795.0 kHz	1.995 MHz	3.2531 MHz	7.500 MHz
	ACP	765.0 kHz	1.995 MHz	3.125 MHz	4.000 MHz	7.500 MHz

Range: 10.0 kHz to 100.0 MHz  
Default Unit: Hz  
Remarks: You must be in the cdma2000, W-CDMA, or 1xEV-DO mode to use this command. Use INSTRument:SElect to set the mode.

### Spectrum Emission Mask—Offset Step Frequency

cdma2000, W-CDMA mode

```
[ :SENSe ] :SEMAsk:OFFSet [n] :LIST:FREQuency:STEP  
<f_offset>, <f_offset>, <f_offset>, <f_offset>, <f_offset>
```

```
[ :SENSe ] :SEMAsk:OFFSet [n] :LIST:FREQuency:STEP?
```

1xEV-DO mode

```
[ :SENSe ] :SEMAsk:OFFSet:LIST[m] :FREQuency:STEP  
<f_offset>, <f_offset>, <f_offset>, <f_offset>, <f_offset>
```

```
[ :SENSe ] :SEMAsk:OFFSet:LIST[m] :FREQuency:STEP?
```

Set the five (5) sets of the offset step frequencies.

OFFSet[n] n=1 is the base station test and n=2 is the mobile test. The default is the base station test (1). (cdma2000, W-CDMA mode only)

LIST[m] m=1 is the spectrum emission mask (SEM) mode and m=2 is the adjacent channel power (ACP) mode. The default is the SEM mode (1). (1xEV-DO mode only)

Factory Preset: No valid value as the default is set to Auto. See [:SENS]:SEM:OFF[n]:LIST[m]:FREQ:STEP:AUTO.

Range: 100 Hz to 7.5 MHz  
The minimum value is determined to be equal to or greater than one 2000th (1/2000) of the frequency difference derived from (Stop Freq – Start Freq).

Default Unit: Hz

Remarks: You must be in the cdma2000, W-CDMA, or 1xEV-DO mode to use this command. Use INSTRument:SElect to set the mode.

### Spectrum Emission Mask—Auto Offset Step Frequency

cdma2000, W-CDMA mode

```
[ :SENSe ] :SEMAsk:OFFSet [n] :LIST:FREQuency:STEP:AUTO
```

OFF | ON | 0 | 1, OFF | ON | 0 | 1, OFF | ON | 0 | 1, OFF | ON | 0 | 1, OFF | ON | 0 | 1

[ :SENSe ] :SEMAsk:OFFSet [n] :LIST:FREQuency:STEP:AUTO?

1xEV-DO mode

[ :SENSe ] :SEMAsk:OFFSet :LIST [m] :FREQuency:STEP:AUTO

OFF | ON | 0 | 1, OFF | ON | 0 | 1, OFF | ON | 0 | 1, OFF | ON | 0 | 1, OFF | ON | 0 | 1

[ :SENSe ] :SEMAsk:OFFSet :LIST [m] :FREQuency:STEP:AUTO?

Set the auto mode to determine the offset step frequency to On or Off.

OFF - enter a value to set the step frequency for an offset channel, referring to [:SENS]:SEM:OFFS[n]:LIST[m]:FREQ:STEP.

ON - the step frequency for an offset channel is automatically set according to the offset start and stop frequencies.

OFFSet[n] n=1 is the base station test and n=2 is the mobile test. The default is the base station test (1). (cdma2000, W-CDMA mode only)

LIST[m] m=1 is the spectrum emission mask (SEM) mode and m=2 is the adjacent channel power (ACP) mode. The default is the SEM mode (1). (1xEV-DO mode only)

Factory Preset:

Mode	Variant	Offset A	Offset B	Offset C	Offset D	Offset E
cdma2000		ON	ON	ON	ON	ON
W-CDMA		ON	ON	ON	ON	ON
1xEV-DO	SEM	ON	ON	ON	ON	ON
	ACP	ON	ON	ON	ON	ON

Remarks: You must be in cdma2000, W-CDMA, or 1xEV-DO mode to use this command. Use INSTRument:SElect to set the mode.

### Spectrum Emission Mask—Offset Stop Frequency

cdma2000, W-CDMA mode

[ :SENSe ] :SEMAsk:OFFSet [n] :LIST:FREQuency:STOP

<f\_offset>, <f\_offset>, <f\_offset>, <f\_offset>, <f\_offset>

[ :SENSe ] :SEMAsk:OFFSet [n] :LIST:FREQuency:STOP?

1xEV-DO mode

[ :SENSe ] :SEMAsk:OFFSet :LIST [m] :FREQuency:STOP

<f\_offset>, <f\_offset>, <f\_offset>, <f\_offset>, <f\_offset>

**[ :SENSe ] :SEMAsk :OFFSet :LIST [m] :FREQuency :STOP?**

Sets the five (5) sets of the offset stop frequencies.

OFFSet[n]      n=1 is the base station test and n=2 is the mobile test.  
The default is the base station test (1). (cdma2000,  
W-CDMA mode only)

LIST[m]        m=1 is the spectrum emission mask (SEM) mode and  
m=2 is the adjacent channel power (ACP) mode. The  
default is the SEM mode (1). (1xEV-DO mode only)

Factory Preset:

Mode	Variant	Offset A	Offset B	Offset C	Offset D	Offset E
cdma2000	BTS	795.0 kHz	1.195 MHz	4.015 MHz	4.0031 MHz	12.50 MHz
	MS	1.995 MHz	4.015 MHz	4.0031 MHz	12.00 MHz	15.00 MHz
W-CDMA	BTS	2.715 MHz	3.515 MHz	4.000 MHz	8.000 MHz	12.50 MHz
	MS	3.485 MHz	7.500 MHz	8.500 MHz	12.00 MHz	15.00 MHz
1xEV-DO	SEM	795.0 kHz	1.995 MHz	4.015 MHz	4.0031 MHz	12.50 MHz
	ACP	765.0 kHz	1.995 MHz	3.125 MHz	4.000 MHz	7.500 MHz

Range:            10.0 kHz to 100.0 MHz

Default Unit:    Hz

Remarks:        You must be in the cdma2000, W-CDMA, or 1xEV-DO  
mode to use this command. Use INSTRument:SElect to  
set the mode.

### Spectrum Emission Mask—Offset Relative Attenuation

cdma2000, W-CDMA mode

**[ :SENSe ] :SEMAsk :OFFSet [n] :LIST :RATTenuation**  
**<rel\_power>, <rel\_power>, <rel\_power>, <rel\_power>, <rel\_power>**

**[ :SENSe ] :SEMAsk :OFFSet [n] :LIST :RATTenuation?**

1xEV-DO mode

**[ :SENSe ] :SEMAsk :OFFSet :LIST [m] :RATTenuation**  
**<rel\_power>, <rel\_power>, <rel\_power>, <rel\_power>, <rel\_power>**

**[ :SENSe ] :SEMAsk :OFFSet :LIST [m] :RATTenuation?**

Set a relative amount of attenuation for the measurements made at an offset channel. The amount is specified relative to the attenuation required to measure the carrier channel. Since the offset channel power is lower than the carrier channel power, less attenuation is required to



measure the offset channel and you get wider dynamic range for the measurement.

You can turn off (not use) specific offset channels with  
[:SENS]:SEM:OFFS[n]:LIST[m]:STAT.

OFFSet[n]      n=1 is the base station test and n=2 is the mobile test. The default is the base station test (1). (cdma2000, W-CDMA mode only)

LIST[m]        m=1 is the spectrum emission mask (SEM) mode and m=2 is the adjacent channel power (ACP) mode. The default is the SEM mode (1). (1xEV-DO mode only)

Factory Preset:

Mode	Offset A	Offset B	Offset C	Offset D	Offset E
cdma2000	0.00 dB	0.00 dB	0.00 dB	0.00 dB	0.00 dB
W-CDMA	0.00 dB	0.00 dB	0.00 dB	0.00 dB	0.00 dB
1xEV-DO	0.00 dB	0.00 dB	0.00 dB	0.00 dB	0.00 dB

Range:            -40.00 to 0.00 dB, but this relative attenuation cannot exceed the absolute attenuation ranging from 0 to 40 dB.

Default Unit:    dB

Remarks:        Remember that the attenuation that you specify is always relative to the amount of attenuation used for the carrier channel. Selecting negative attenuation means that you want less attenuation used. For example, if the measurement must use 20 dB of attenuation for the carrier measurement and you want to use 12 dB less attenuation for the first offset, you would send the value -12 dB.

You must be in the cdma2000, W-CDMA, or 1xEV-DO mode to use this command. Use INSTRument:SElect to set the mode.

### Spectrum Emission Mask—Offset Frequency Side

cdma2000, W-CDMA mode

**[:SENSe]:SEMAsk:OFFSet [n]:LIST:SIDE BOTH|NEGAtive|POSitive, BOTH|NEGAtive|POSitive, BOTH|NEGAtive|POSitive, BOTH|NEGAtive|POSitive**

**[:SENSe]:SEMAsk:OFFSet [n]:LIST:SIDE?**

1xEV-DO mode

```
[ :SENSe ] :SEMAsk:OFFSet:LIST[m] :SIDE BOTH | NEGative | POSitive,
BOTH | NEGative | POSitive, BOTH | NEGative | POSitive,
BOTH | NEGative | POSitive, BOTH | NEGative | POSitive
```

```
[ :SENSe ] :SEMAsk:OFFSet:LIST[m] :SIDE?
```

Specify which sideband will be measured. You can turn off (not use) specific offsets with [:SENS]:SEM:OFFS[n]:LIST[m]:STAT.

BOTH - both of the negative (lower) and positive (upper) sidebands

NEGative - negative (lower) sideband only

POSitive - positive (upper) sideband only

OFFSet[n]      n=1 is the base station test and n=2 is the mobile test. The default is the base station test (1). (cdma2000, W-CDMA mode only)

LIST[m]        m=1 is the spectrum emission mask (SEM) mode and m=2 is the adjacent channel power (ACP) mode. The default is the SEM mode (1). (1xEV-DO mode only)

Factory Preset:

Mode	Variant	Offset A	Offset B	Offset C	Offset D	Offset E
cdma2000		BOTH	BOTH	BOTH	BOTH	BOTH
W-CDMA		BOTH	BOTH	BOTH	BOTH	BOTH
1xEV-DO	SEM	BOTH	BOTH	BOTH	BOTH	BOTH
	ACP	BOTH	BOTH	BOTH	BOTH	BOTH

Remarks:      You must be in the cdma2000, W-CDMA, or 1xEV-DO mode to use this command. Use INSTRument:SElect to set the mode.

### Spectrum Emission Mask—Offset Start Absolute Power Limit

cdma2000, W-CDMA mode

```
[ :SENSe ] :SEMAsk:OFFSet [n] :LIST:START:ABSolute
<abs_power>, <abs_power>, <abs_power>, <abs_power>, <abs_power>
```

```
[ :SENSe ] :SEMAsk:OFFSet [n] :LIST:START:ABSolute?
```

1xEV-DO mode

```
[ :SENSe ] :SEMAsk:OFFSet:LIST [m] :START:ABSolute
<abs_power>, <abs_power>, <abs_power>, <abs_power>, <abs_power>
```

```
[ :SENSe ] :SEMAsk:OFFSet:LIST [M] :START:ABSolute?
```

Sets an absolute power level for each offset start limit. The list must

contain five (5) entries. If there is more than one offset, the offset closest to the carrier channel comes first in the list.

The fail condition for each offset channel is set by  
[:SENSe]:SEM:OFFS[n]:LIST[m]:TEST.

You can turn off (not use) specific offset channels with  
[:SENSe]:SEM:OFFS[n]:LIST[m]:STAT.

The query returns the five (5) sets of the real values currently set to the absolute power test limits.

OFFSet[n]      n=1 is the base station test and n=2 is the mobile test.  
The default is the base station test (1). (cdma2000,  
W-CDMA mode only)

LIST[m]        m=1 is the spectrum emission mask (SEM) mode and  
m=2 is the adjacent channel power (ACP) mode. The  
default is the SEM mode (1). (1xEV-DO mode only)

Factory Preset:

Mode	Variant	Offset A	Offset B	Offset C	Offset D	Offset E
cdma2000	BTS	-27.0 dBm	-27.0 dBm	-27.0 dBm	-46.00 dBm	-13.00 dBm
	MS	-70.13 dBm	-70.13 dBm	-35.00 dBm	-13.00 dBm	-13.00 dBm
W-CDMA	BTS	-12.50 dBm	-12.50 dBm	-24.50 dBm	-11.50 dBm	-11.50 dBm
	MS	-69.57 dBm	-54.34 dBm	-54.34 dBm	-54.34 dBm	-54.34 dBm
1xEV-DO	SEM	-27.00 dBm	-27.00 dBm	-27.00 dBm	-46.00 dBm	-13.00 dBm
	ACP	-27.00 dBm	-27.00 dBm	-13.00 dBm	-13.00 dBm	-13.00 dBm

Range:            -200.0 dBm to 50.0 dBm

Default Unit:    dBm

Remarks:        You must be in the cdma2000, W-CDMA, or 1xEV-DO  
mode to use this command. Use INSTRument:SElect to  
set the mode.

### Spectrum Emission Mask—Offset Start Relative Power Limit

cdma2000, W-CDMA mode

```
[:SENSe]:SEMAsk:OFFSet [n]:LIST:STARt:RCARrier
<rel_power>, <rel_power>, <rel_power>, <rel_power>, <rel_power>
```

```
[:SENSe]:SEMAsk:OFFSet [n]:LIST:STARt:RCARrier?
```

1xEV-DO mode

```
[:SENSe]:SEMAsk:OFFSet:LIST [m]:STARt:RCARrier
```

<rel\_power>, <rel\_power>, <rel\_power>, <rel\_power>, <rel\_power>

**[ :SENSe ] :SEMAsk:OFFSet:LIST[m] :START:RCARrier?**

Set a relative power level for each offset start limit. The list must contain five (5) entries. If there is more than one offset, the offset closest to the carrier channel comes first in the list.

The fail condition is set by [:SENS]:SEM:OFFS[n]:LIST[m]:TEST for each offset channel test.

You can turn off (not use) specific offset channels with [:SENS]:SEM:OFFS[n]:LIST[m]:STAT.

The query returns the five (5) sets of the real values currently set to the relative power test limits.

OFFSet[n]      n=1 is the base station test and n=2 is the mobile test. The default is the base station test (1). (cdma2000, W-CDMA mode only)

LIST[m]        m=1 is the spectrum emission mask (SEM) mode and m=2 is the adjacent channel power (ACP) mode. The default is the SEM mode (1). (1xEV-DO mode only)

Factory Preset:

Mode	Variant	Offset A	Offset B	Offset C	Offset D	Offset E
cdma2000	BTS	-45.00 dB	-45.00 dB	-55.00 dB	-55.00 dB	-55.00 dB
	MS	-42.00 dB	-54.00 dB	-54.00 dB	-54.00 dB	-54.00 dB
W-CDMA	BTS	-30.00 dB	-30.00 dB	-30.00 dB	-30.00 dB	-30.00 dB
	MS	-33.73 dB	-34.00 dB	-37.50 dB	-47.50 dB	-47.50 dB
1xEV-DO	SEM	-45.00 dB	-45.00 dB	-55.00 dB	-55.00 dB	-55.00 dB
	ACP	-45.00 dB	-55.00 dB	-55.00 dB	-55.00 dB	-55.00 dB

Range:            -150.0 dBm to 50.0 dB

Default Unit:    dB

Remarks:        You must be in the cdma2000, W-CDMA, or 1xEV-DO mode to use this command. Use INSTRument:SElect to set the mode.

### Spectrum Emission Mask—Offset Measurement State

cdma2000, W-CDMA mode

**[ :SENSe ] :SEMAsk:OFFSet [n] :LIST:STATe**

OFF | ON | 0 | 1, OFF | ON | 0 | 1, OFF | ON | 0 | 1, OFF | ON | 0 | 1, OFF | ON | 0 | 1

**[ :SENSe ] :SEMAsk:OFFSet [n] :LIST:STATe?**

1xEV-DO mode

**[ :SENSe ] :SEMAsk:OFFSet:LIST [m] :STATe**

**OFF | ON | 0 | 1, OFF | ON | 0 | 1, OFF | ON | 0 | 1, OFF | ON | 0 | 1, OFF | ON | 0 | 1**

**[ :SENSe ] :SEMAsk:OFFSet:LIST [m] :STATe?**

Define whether or not to execute pass/fail tests at the offset channels. The pass/fail conditions are set by [:SENS]:SEM:OFFS[n]:LIST[m]:ABS or [:SENS]:SEM:OFFS[n]:LIST[m]:RCAR for each offset channel.

**OFFSet[n]** n=1 is the base station test and n=2 is the mobile test. The default is the base station test (1). (cdma2000, W-CDMA mode only)

**LIST[m]** m=1 is the spectrum emission mask (SEM) mode and m=2 is the adjacent channel power (ACP) mode. The default is the SEM mode (1). (1xEV-DO mode only)

Factory Preset:

Mode	Variant	Offset A	Offset B	Offset C	Offset D	Offset E
cdma2000	BTS	ON	ON	ON	OFF	OFF
	MS	ON	ON	OFF	OFF	OFF
W-CDMA	BTS	ON	ON	ON	ON	ON
	MS	ON	ON	ON	ON	OFF
1xEV-DO	SEM	ON	ON	ON	OFF	OFF
	ACP	ON	ON	OFF	OFF	OFF

**Remarks:** You must be in the cdma2000, W-CDMA, or 1xEV-DO mode to use this command. Use INSTRument:SElect to set the mode.

### Spectrum Emission Mask—Offset Stop Absolute Power Limit

cdma2000, W-CDMA mode

**[ :SENSe ] :SEMAsk:OFFSet [n] :LIST:STOP:ABSolute**

**<abs\_power>, <abs\_power>, <abs\_power>, <abs\_power>, <abs\_power>**

**[ :SENSe ] :SEMAsk:OFFSet [n] :LIST:STOP:ABSolute?**

1xEV-DO. mode

**[ :SENSe ] :SEMAsk:OFFSet:LIST [m] :STOP:ABSolute**

**<abs\_power>, <abs\_power>, <abs\_power>, <abs\_power>, <abs\_power>**

**[ :SENSe ] :SEMAsk:OFFSet:LIST [m] :STOP:ABSolute?**

Set an absolute power level to for each offset stop limit. The list must contain five (5) entries. If there is more than one offset, the offset closest to the carrier channel comes first in the list.

The fail condition is set by [:SENS]:SEM:OFFS[n]:LIST[m]:TEST for each offset channel test.

You can turn off (not use) specific offset channels with [:SENS]:SEM:OFFS[n]:LIST[m]:STAT.

The query returns the five (5) sets of the real values currently set to the offset stop absolute power limits.

OFFSet[n]      n=1 is the base station test and n=2 is the mobile test. The default is the base station test (1). (cdma2000, W-CDMA mode only)

LIST[m]        m=1 is the spectrum emission mask (SEM) mode and m=2 is the adjacent channel power (ACP) mode. The default is the SEM mode (1). (1xEV-DO mode only)

Factory Preset:

Mode	Variant	Offset A	Offset B	Offset C	Offset D	Offset E
cdma2000	BTS	-27.00 dBm	-27.00 dBm	-27.00 dBm	-46.00 dBm	-13.00 dBm
	MS	-70.13 dBm	-70.13 dBm	-35.00 dBm	-13.00 dBm	-13.00 dBm
W-CDMA	BTS	-12.50 dBm	-24.50 dBm	-24.50 dBm	-11.50 dBm	-11.50 dBm
	MS	-69.57 dBm	-54.34 dBm	-54.34 dBm	-54.34 dBm	-54.34 dBm
1xEV-DO	SEM	-27.00 dBm	-27.00 dBm	-27.00 dBm	-46.00 dBm	-13.00 dBm
	ACP	-27.00 dBm	-27.00 dBm	-13.00 dBm	-13.00 dBm	-13.00 dBm

Range:            -200.0 dBm to 50.0 dBm

Default Unit:    dBm

Remarks:        You must be in the cdma2000, W-CDMA, or 1xEV-DO mode to use this command. Use INSTRument:SElect to set the mode.

### Spectrum Emission Mask—Couple Offset Stop Absolute Power Limit

cdma2000, W-CDMA mode

**[:SENSe]:SEMAsk:OFFSet [n]:LIST:STOP:ABSolute:COUple  
OFF|ON|0|1, OFF|ON|0|1, OFF|ON|0|1, OFF|ON|0|1, OFF|ON|0|1**

**[:SENSe]:SEMAsk:OFFSet [n]:LIST:STOP:ABSolute:COUple?**

1xEV-DO mode

```
[ :SENSe] :SEMAsk:OFFSet:LIST [m] :STOP:ABSolute:COUPlE
OFF | ON | 0 | 1, OFF | ON | 0 | 1, OFF | ON | 0 | 1, OFF | ON | 0 | 1, OFF | ON | 0 | 1
```

```
[ :SENSe] :SEMAsk:OFFSet:LIST [m] :STOP:ABSolute:COUPlE?
```

Define whether or not to couple the offset stop absolute power limit to the offset start absolute power limit for each offset channel.

You can turn off (not use) specific offset channels with  
[:SENS]:SEM:OFFS[n]:LIST[m]:STAT.

OFFSet[n]      n=1 is the base station test and n=2 is the mobile test. The default is the base station test (1). (cdma2000, W-CDMA mode only)

LIST[m]        m=1 is the spectrum emission mask (SEM) mode and m=2 is the adjacent channel power (ACP) mode. The default is the SEM mode (1). (1xEV-DO mode only)

Factory Preset:

Mode	Variant	Offset A	Offset B	Offset C	Offset D	Offset E
cdma2000	BTS	ON	ON	ON	ON	ON
	MS	ON	ON	ON	ON	ON
W-CDMA	BTS	ON	OFF	ON	ON	ON
	MS	ON	ON	ON	ON	ON
1xEV-DO	SEM	ON	ON	ON	ON	ON
	ACP	ON	ON	ON	ON	ON

Remarks:      You must be in the cdma2000, W-CDMA, or 1xEV-DO mode to use this command. Use INSTRument:SElect to set the mode.

### Spectrum Emission Mask—Offset Stop Relative Power Limit

cdma2000, W-CDMA mode

```
[ :SENSe] :SEMAsk:OFFSet [n] :LIST:STOP:RCARrier
<rel_power>, <rel_power>, <rel_power>, <rel_power>, <rel_power>
```

```
[ :SENSe] :SEMAsk:OFFSet [n] :LIST:STOP:RCARrier?
```

1xEV-DO mode

```
[ :SENSe] :SEMAsk:OFFSet:LIST [m] :STOP:RCARrier
<rel_power>, <rel_power>, <rel_power>, <rel_power>, <rel_power>
```

```
[ :SENSe] :SEMAsk:OFFSet:LIST [m] :STOP:RCARrier?
```

Set a relative power level for each offset stop limit. The list must contain five (5) entries. If there is more than one offset, the offset closest to the carrier channel comes first in the list.

The fail condition is set by [:SENS]:SEM:OFFS[n]:LIST[m]:TEST for each offset channel.

You can turn off (not use) specific offset channels with [:SENS]:SEM:OFFS[n]:LIST[m]:STAT.

The query returns the five (5) sets of the real values currently set to the offset stop relative power limits.

OFFSet[n]      n=1 is the base station test and n=2 is the mobile test. The default is the base station test (1). (cdma2000, W-CDMA mode only)

LIST[m]        m=1 is the spectrum emission mask (SEM) mode and m=2 is the adjacent channel power (ACP) mode. The default is the SEM mode (1). (1xEV-DO mode only)

Factory Preset:

Mode	Variant	Offset A	Offset B	Offset C	Offset D	Offset E
cdma2000	BTS	-45.00 dB	-45.00 dB	-55.00 dB	-55.00 dB	-55.00 dB
	MS	-42.00 dB	-54.00 dB	-54.00 dB	-54.00 dB	-54.00 dB
W-CDMA	BTS	-30.00 dB	-30.00 dB	-30.00 dB	-30.00 dB	-30.00 dB
	MS	-48.28 dB	-37.50 dB	-47.50 dB	-47.50 dB	-47.50 dB
1xEV-DO	SEM	-45.00 dB	-45.00 dB	-55.00 dB	-55.00 dB	-55.00 dB
	ACP	-45.00 dB	-55.00 dB	-55.00 dB	-55.00 dB	-55.00 dB

Range:            -150.0 dBm to 50.0 dB

Default Unit:    dB

Remarks:        You must be in the cdma2000, W-CDMA, or 1xEV-DO mode to use this command. Use INSTRument:SElect to set the mode.

### Spectrum Emission Mask—Couple Offset Stop Relative Power Limit

cdma2000, W-CDMA mode

**[:SENSe]:SEMAsk:OFFSet [n]:LIST:STOP:RCARrier:COUple  
OFF|ON|0|1,OFF|ON|0|1,OFF|ON|0|1,OFF|ON|0|1,OFF|ON|0|1**

**[:SENSe]:SEMAsk:OFFSet [n]:LIST:STOP:RCARrier:COUple?**



1xEV-DO mode

**[ :SENSe] :SEMAsk:OFFSet:LIST[m] :STOP:RCARrier:COUPle  
OFF|ON|0|1, OFF|ON|0|1, OFF|ON|0|1, OFF|ON|0|1, OFF|ON|0|1**

**[ :SENSe] :SEMAsk:OFFSet:LIST[m] :STOP:RCARrier:COUPle?**

Define whether or not to couple the offset stop relative power limit to the offset start relative power limit for each offset channel.

You can turn off (not use) specific offset channels with  
[:SENS]:SEM:OFFS[n]:LIST[m]:STAT.

OFFSet[n]      n=1 is the base station test and n=2 is the mobile test.  
The default is the base station test (1). (cdma2000,  
W-CDMA mode only)

LIST[m]        m=1 is the spectrum emission mask (SEM) mode and  
m=2 is the adjacent channel power (ACP) mode. The  
default is the SEM mode (1). (1xEV-DO mode only)

Factory Preset:

Mode	Variant	Offset A	Offset B	Offset C	Offset D	Offset E
cdma2000	BTS	ON	ON	ON	ON	ON
	MS	ON	ON	ON	ON	ON
W-CDMA	BTS	ON	ON	ON	ON	ON
	MS	OFF	OFF	OFF	ON	ON
1xEV-DO	SEM	ON	ON	ON	ON	ON
	ACP	ON	ON	ON	ON	ON

Remarks:      You must be in the cdma2000, W-CDMA, or 1xEV-DO  
mode to use this command. Use INSTRument:SElect to  
set the mode.

### Spectrum Emission Mask—Offset Channel Fail Condition

cdma2000, W-CDMA mode

**[ :SENSe] :SEMAsk:OFFSet [n] :LIST:TEST  
ABSolute|AND|OR|RELative, ABSolute|AND|OR|RELative,  
ABSolute|AND|OR|RELative, ABSolute|AND|OR|RELative,  
ABSolute|AND|OR|RELative**

**[ :SENSe] :SEMAsk:OFFSet [n] :LIST:TEST?**

1xEV-DO mode

**[ :SENSe] :SEMAsk:OFFSet:LIST[m] :TEST**

**ABSolute** | **AND** | **OR** | **RELative**, **ABSolute** | **AND** | **OR** | **RELative**,  
**ABSolute** | **AND** | **OR** | **RELative**, **ABSolute** | **AND** | **OR** | **RELative**,  
**ABSolute** | **AND** | **OR** | **RELative**

**[ :SENSe ] :SEMAsk :OFFSet :LIST [m] :TEST?**

Define one of the fail conditions for each offset channel limit test to be done. The absolute or relative power limit value for each offset channel is set by [:SENS]:SEM:OFFS[n]:LIST[m]:ABS or [:SENS]:SEM:OFFS[n]:LIST[m]:RCAR.

You can turn off (not use) specific offset channels with [:SENS]:SEM:OFFS[n]:LIST[m]:STAT.

**OFFSet[n]**      n=1 is the base station test and n=2 is the mobile test. The default is the base station test (1). (cdma2000, W-CDMA mode only)

**LIST[m]**        m=1 is the spectrum emission mask (SEM) mode and m=2 is the adjacent channel power (ACP) mode. The default is the SEM mode (1). (1xEV-DO mode only)

The fail condition that can be set for each offset channel include:

- **AND** - Tests the measurement result for an offset channel against both the absolute power limit and the relative power limit. If it fails, then returns a failure for that measurement test.
- **ABSolute** - Tests the measurement result for an offset channel against the absolute power limit. If it fails, then returns a failure for that measurement test.
- **OR** - Tests the measurement result for an offset channel against the absolute power limit OR the relative power limit. If either test fails, then returns a failure for that measurement test.
- **RELative** - Tests the measurement result for an offset channel against the relative power limit. If it fails, then returns a failure for that measurement test.

Factory Preset:

Mode	Variant	Offset A	Offset B	Offset C	Offset D	Offset E
cdma2000	BTS	REL	REL	REL	ABS	REL
	MS	AND	AND	ABS	REL	REL
W-CDMA	BTS	ABS	ABS	ABS	ABS	ABS
	MS	AND	AND	AND	AND	AND
1xEV-DO	SEM	REL	REL	REL	ABS	REL
	ACP	REL	REL	ABS	REL	REL

Remarks: You must be in the cdma2000, W-CDMA, or 1xEV-DO mode to use this command. Use INSTRument:SElect to set the mode.

### Spectrum Emission Mask—Region Resolution Bandwidth

cdma2000, W-CDMA mode

```
[ :SENSe ] :SEMask:REGion [n] :LIST:BAWdwidth | BWIDTh
<res_bw>, <res_bw>, <res_bw>, <res_bw>, <res_bw>
```

```
[ :SENSe ] :SEMask:REGion [n] :LIST:BAWdwidth | BWIDTh?
```

1xEV-DO mode

```
[ :SENSe ] :SEMask:REGion:LIST:BAWdwidth | BWIDTh
<res_bw>, <res_bw>, <res_bw>, <res_bw>, <res_bw>
```

```
[ :SENSe ] :SEMask:REGion:LIST:BAWdwidth | BWIDTh?
```

Define the region resolution bandwidth(s) for spectrum emission measurements. The list must contain five (5) entries. You can turn off (not use) specific regions with [:SENS]:SEM:REG[n]:LIST:STAT.

REGion[n] n=1 is the base station test and n=2 is the mobile test. The default is the base station test (1). (cdma2000, W-CDMA mode only)

Factory Preset and \*RST: Auto coupled, except cdma2000, see below.

Mode	Variant	Region A	Region B	Region C	Region D	Region E
cdma2000	BTS	1.000 MHz	300.0 kHz	100.0 kHz	100.0 kHz	4.000 MHz
	MS	300.0 kHz	100.0 kHz	100.0 kHz	100.0 kHz	12.00 MHz

Range: 300 Hz to 7.5 MHz

Default Unit: Hz

Remarks: You must be in the cdma2000, W-CDMA, or 1xEV-DO mode to use this command. Use INSTRument:SElect to set the mode.

### Spectrum Emission Mask—Auto Region Resolution Bandwidth

cdma2000, W-CDMA mode

```
[ :SENSe ] :SEMask:REGion [n] :LIST:BAWdwidth | BWIDTh:AUTO
OFF | ON | 0 | 1, OFF | ON | 0 | 1, OFF | ON | 0 | 1, OFF | ON | 0 | 1, OFF | ON | 0 | 1
```

**[[:SENSe]:SEMask:REGion[n]:LIST:BANDwidth|BWIDth:AUTO?**

1xEV-DO mode

**[[:SENSe]:SEMask:REGion:LIST:BANDwidth|BWIDth:AUTO  
OFF|ON|0|1,OFF|ON|0|1,OFF|ON|0|1,OFF|ON|0|1,OFF|ON|0|1**

**[[:SENSe]:SEMask:REGion:LIST:BANDwidth|BWIDth:AUTO?**

Set the auto mode of the region step frequency.

Set the auto mode to determine the region resolution bandwidth to On or Off.

OFF - enter a value to set the resolution bandwidth for a region channel, referring to [:SENS]:SEM:REG[n]:LIST:BAND|BWID.

ON - the resolution bandwidth for a region channel is automatically set according to the region start and stop frequencies.

REGion[n] n=1 is the base station test and n=2 is the mobile test. The default is the base station test (1). (cdma2000, W-CDMA mode only)

Factory Preset and \*RST:

Mode	Region A	Region B	Region C	Region D	Region E
cdma2000	OFF	OFF	OFF	OFF	OFF
W-CDMA	ON	ON	ON	ON	ON
1xEV-DO	ON	ON	ON	ON	ON

Remarks: You must be in the cdma2000, W-CDMA, or 1xEV-DO mode to use this command. Use INSTRument:SElect to set the mode.

### Spectrum Emission Mask—Region Start Frequency

cdma2000, W-CDMA mode

**[[:SENSe]:SEMask:REGion[n]:LIST:FREQuency:START  
<f\_region>,<f\_region>,<f\_region>,<f\_region>,<f\_region>**

**[[:SENSe]:SEMask:REGion[n]:LIST:FREQuency:START?**

1xEV-DO mode

**[[:SENSe]:SEMask:REGion:LIST:FREQuency:START  
<f\_region>,<f\_region>,<f\_region>,<f\_region>,<f\_region>**

**[[:SENSe]:SEMask:REGion:LIST:FREQuency:START?**

Set the five (5) sets of the region start frequencies.

REGion[n] n=1 is the base station test and n=2 is the mobile test.  
The default is the base station test (1). (cdma2000,  
W-CDMA mode only)

Factory Preset and \*RST:

Mode	Variant	Region A	Region B	Region C	Region D	Region E
cdma2000	BTS	1920.5 MHz	1893.65 MHz	876.05 MHz	921.05 MHz	800.0 MHz
	MS	1920.5 MHz	925.05 MHz	935.05 MHz	1805.05 MHz	800.0 MHz
W-CDMA	n/a	1920.0 MHz	1893.5 MHz	2100.0 MHz	2175.0 MHz	800.0 MHz
1xEV-DO	n/a	1920.0 MHz	1893.5 MHz	2100.0 MHz	2175.0 MHz	800.0 MHz

Range: 329.0 MHz to 3.678 GHz

Default Unit: Hz

Remarks: You must be in the cdma2000, W-CDMA, or 1xEV-DO mode to use this command. Use INSTRument:SElect to set the mode.

### Spectrum Emission Mask—Region Step Frequency

cdma2000, W-CDMA mode

```
[ :SENSE] :SEMAsk:REGion[n] :LIST:FREQuency:STEP
<f_region>, <f_region>, <f_region>, <f_region>, <f_region>
```

```
[ :SENSe] :SEMAsk:REGion[n] :LIST:FREQuency:STEP?
```

1xEV-DO mode

```
[ :SENSe] :SEMAsk:REGion:LIST:FREQuency:STEP
<f_region>, <f_region>, <f_region>, <f_region>, <f_region>
```

```
[ :SENSe] :SEMAsk:REGion:LIST:FREQuency:STEP?
```

Sets the five (5) sets of the region step frequencies.

REGion[n] n=1 is the base station test and n=2 is the mobile test.  
The default is the base station test (1). (cdma2000,  
W-CDMA mode only)

Factory Preset: No valid value as the default is set to Auto. See  
[:SENS]:SEM:REG[n]:LIST:FREQ:STEP:AUTO.

Range: 100 Hz to 7.5 MHz

The minimum value is determined to be equal to or greater than one 2000th (1/2000) of the frequency difference derived from (Stop Freq – Start Freq).

Default Unit: Hz

Remarks: You must be in the cdma2000, W-CDMA, or 1xEV-DO mode to use this command. Use INSTRument:SElect to set the mode.

### Spectrum Emission Mask—Auto Region Step Frequency

cdma2000, W-CDMA mode

**[ :SENSe ] :SEMAsk :REGion [n] :LIST:FREQuency:STEP:AUTO  
OFF | ON | 0 | 1, OFF | ON | 0 | 1, OFF | ON | 0 | 1, OFF | ON | 0 | 1, OFF | ON | 0 | 1**

**[ :SENSe ] :SEMAsk :REGion [n] :LIST:FREQuency:STEP:AUTO?**

1xEV-DO mode

**[ :SENSe ] :SEMAsk :REGion:LIST:FREQuency:STEP:AUTO  
OFF | ON | 0 | 1, OFF | ON | 0 | 1, OFF | ON | 0 | 1, OFF | ON | 0 | 1, OFF | ON | 0 | 1**

**[ :SENSe ] :SEMAsk :REGion:LIST:FREQuency:STEP:AUTO?**

Set the auto mode to determine the region step frequency to On or Off.

OFF - enter a value to set the step frequency for a region channel, referring to [:SENS]:SEM:REG[n]:LIST:FREQ:STEP.

ON - the step frequency for a region channel is automatically set according to the region start and stop frequencies.

REGion[n] n=1 is the base station test and n=2 is the mobile test. The default is the base station test (1). (cdma2000, W-CDMA mode only)

Factory Preset:

Mode	Region A	Region B	Region C	Region D	Region E
cdma2000	ON	ON	ON	ON	ON
W-CDMA	ON	ON	ON	ON	ON
1xEV-DO	ON	ON	ON	ON	ON

Remarks: You must be in the cdma2000, W-CDMA, or 1xEV-DO mode to use this command. Use INSTRument:SElect to set the mode.

### Spectrum Emission Mask—Region Stop Frequency

cdma2000, W-CDMA mode

**[ :SENSe ] :SEMAsk :REGion [n] :LIST:FREQuency:STOP**

<f\_region>, <f\_region>, <f\_region>, <f\_region>, <f\_region>

[ :SENSE ] :SEMAsk:REGion[n] :LIST:FREQuency:STOP?

1xEV-DO mode

[ :SENSE ] :SEMAsk:REGion:LIST:FREQuency:STOP

<f\_region>, <f\_region>, <f\_region>, <f\_region>, <f\_region>

[ :SENSE ] :SEMAsk:REGion:LIST:FREQuency:STOP?

Sets the five (5) sets of the region stop frequencies.

REGion[n]      n=1 is the base station test and n=2 is the mobile test.  
The default is the base station test (1). (cdma2000,  
W-CDMA mode only)

Factory Preset and \*RST:

Mode	Variant	Region A	Region B	Region C	Region D	Region E
cdma2000	BTS	1980.5 MHz	1919.75 MHz	915.05 MHz	960.05 MHz	1000.0 MHz
	MS	1980.5 MHz	935.05 MHz	960.05 MHz	1880.05 MHz	1000.0 MHz
W-CDMA	n/a	1980.0 MHz	1919.6 MHz	2105.0 MHz	2180.0 MHz	1000.0 MHz
1xEV-DO	n/a	1980.0 MHz	1919.6 MHz	2105.0 MHz	2180.0 MHz	1000.0 MHz

Range:            329.0 MHz to 3.678 MHz

Default Unit:    Hz

Remarks:        You must be in the cdma2000, W-CDMA, or 1xEV-DO mode to use this command. Use INSTRument:SElect to set the mode.

### Spectrum Emission Mask—Region Relative Attenuation

cdma2000, W-CDMA mode

[ :SENSE ] :SEMAsk:REGion[n] :LIST:RATTenuation

<rel\_power>, <rel\_power>, <rel\_power>, <rel\_power>, <rel\_power>

[ :SENSE ] :SEMAsk:REGion[n] :LIST:RATTenuation?

1xEV-DO mode

[ :SENSE ] :SEMAsk:REGion:LIST:RATTenuation

<rel\_power>, <rel\_power>, <rel\_power>, <rel\_power>, <rel\_power>

[ :SENSE ] :SEMAsk:REGion:LIST:RATTenuation?

Set a relative amount of attenuation for measurements made at a region. The amount is specified relative to the attenuation required to

measure the carrier channel power. Since the region channel power is lower than the carrier channel power, less attenuation is required to measure the region channel and you get wider dynamic range for the measurement.

You can turn off (not use) specific regions with  
[:SENS]:SEM:REG[n]:LIST:STAT.

REGion[n]      n=1 is the base station test and n=2 is the mobile test.  
The default is the base station test (1). (cdma2000,  
W-CDMA mode only)

Factory Preset:

Mode	Variant	Region A	Region B	Region C	Region D	Region E
cdma2000	BTS	0.00 dB	0.00 dB	0.00 dB	0.00 dB	0.00 dB
	MS	0.00 dB	0.00 dB	0.00 dB	0.00 dB	0.00 dB
W-CDMA	n/a	0.00 dB	0.00 dB	0.00 dB	0.00 dB	0.00 dB
1xEV-DO	n/a	0.00 dB	0.00 dB	0.00 dB	0.00 dB	0.00 dB

Range:            -40.00 to 0.00 dB, but this relative attenuation cannot  
exceed the absolute attenuation ranging from 0.00 to  
40.00 dB.

Remarks:        Remember that the attenuation that you specify is  
always relative to the amount of attenuation used for  
the carrier channel. Selecting negative attenuation  
means that you want less attenuation used. For  
example, if the measurement must use 20 dB of  
attenuation for the carrier measurement and you want  
to use 12 dB less attenuation for the first region, you  
would send the value -12 dB.

You must be in the cdma2000, W-CDMA, or 1xEV-DO  
mode to use this command. Use INSTRument:SElect to  
set the mode.

### Spectrum Emission Mask—Region Start Absolute Power Limit

cdma2000, W-CDMA (3GPP) mode

```
[:SENSe]:SEMAsk:REGion[n]:LIST:START:ABSolute
<abs_power>,<abs_power>,<abs_power>,<abs_power>,<abs_power>
```

```
[:SENSe]:SEMAsk:REGion[n]:LIST:START:ABSolute?
```

1xEV-DO mode

```
[:SENSe]:SEMAsk:REGion:LIST:START:ABSolute
<abs_power>,<abs_power>,<abs_power>,<abs_power>,<abs_power>
```



**[ :SENSe ] :SEMAsk:REGion:LIST:START:ABSolute?**

Set an absolute power level for each region start limit. The list must contain five (5) entries. If there is more than one region, the region closest to the carrier channel comes first in the list.

The fail condition for each region channel is set by  
[:SENS]:SEM:REG[n]:LIST:TEST.

You can turn off (not use) specific regions with  
[:SENS]:SEM:REG[n]:LIST:STAT.

The query returns the five (5) sets of the real values currently set to the absolute power test limits.

REGion[n]      n=1 is the base station test and n=2 is the mobile test.  
The default is the base station test (1). (cdma2000,  
W-CDMA mode only)

Factory Preset:

Mode	Variant	Region A	Region B	Region C	Region D	Region E
cdma2000	BTS	-86.00 dBm	-41.00 dBm	-98.00 dBm	-57.00 dBm	-50.00 dBm
	MS	-41.00 dBm	-67.00 dBm	-79.00 dBm	-71.00 dBm	-50.00 dBm
W-CDMA		-50.00 dBm	-50.00 dBm	-50.00 dBm	-50.00 dBm	-50.00 dBm
1xEV-DO		-50.00 dBm	-50.00 dBm	-50.00 dBm	-50.00 dBm	-50.00 dBm

Range:            -200.00 dBm to 50.00 dBm

Default Unit:    dBm

Remarks:        You must be in the cdma2000, W-CDMA, or 1xEV-DO mode to use this command. Use INSTRument:SElect to set the mode.

**Spectrum Emission Mask—Region Start Relative Power Limit**

cdma2000, W-CDMA mode

**[ :SENSe ] :SEMAsk:REGion [n] :LIST:START:RCARrier**  
**<rel\_power>, <rel\_power>, <rel\_power>, <rel\_power>, <rel\_power>**

**[ :SENSe ] :SEMAsk:REGion [n] :LIST:START:RCARrier?**

1xEV-DO mode

**[ :SENSe ] :SEMAsk:REGion:LIST:START:RCARrier**  
**<rel\_power>, <rel\_power>, <rel\_power>, <rel\_power>, <rel\_power>**

**[ :SENSe ] :SEMAsk:REGion:LIST:START:RCARrier?**

Set a relative power level for each region start limit. The list must

contain five (5) entries. If there is more than one region, the region closest to the carrier channel comes first in the list.

The fail condition is set by [:SENS]:SEM:REG[n]:LIST:TEST for each region test.

You can turn off (not use) specific regions with [:SENS]:SEM:REG[n]:LIST:STAT.

The query returns the five (5) sets of the real values currently set to the relative power test limits.

REGion[n]      n=1 is the base station test and n=2 is the mobile test.  
The default is the base station test (1). (cdma2000, W-CDMA mode only)

Factory Preset:

Mode	Region A	Region B	Region C	Region D	Region E
cdma2000	-30.00 dB	-30.00 dB	-30.00 dB	-30.00 dB	-30.00 dB
W-CDMA	-30.00 dB	-30.00 dB	-30.00 dB	-30.00 dB	-30.00 dB
1xEV-DO	-30.00 dB	-30.00 dB	-30.00 dB	-30.00 dB	-30.00 dB

Range:            -150.00 dBm to 50.00 dB

Default Unit:    dB

Remarks:        You must be in the cdma2000, W-CDMA, or 1xEV-DO mode to use this command. Use INSTRument:SElect to set the mode.

### Spectrum Emission Mask—Control Region List State

cdma2000, W-CDMA mode

**[:SENSe]:SEMAsk:REGion[n]:LIST:STATE**  
OFF|ON|0|1, OFF|ON|0|1, OFF|ON|0|1, OFF|ON|0|1, OFF|ON|0|1

**[:SENSe]:SEMAsk:REGion[n]:LIST:STATE?**

1xEV-DO mode

**[:SENSe]:SEMAsk:REGion:LIST:STATE**  
OFF|ON|0|1, OFF|ON|0|1, OFF|ON|0|1, OFF|ON|0|1, OFF|ON|0|1

**[:SENSe]:SEMAsk:REGion:LIST:STATE?**

Define whether or not to execute pass/fail tests at custom region frequencies. The pass/fail conditions are set by [:SENS]:SEM:REG[n]:LIST:ABS or [:SENS]:SEM:REG[n]:LIST:RCAR for each region.

REGion[n] n=1 is the base station test and n=2 is the mobile test.  
The default is the base station test (1). (cdma2000,  
W-CDMA mode only)

Factory Preset and \*RST:

Mode	Region A	Region B	Region C	Region D	Region E
cdma2000	ON	ON	OFF	OFF	OFF
W-CDMA	ON	ON	ON	OFF	OFF
1xEV-DO	ON	ON	ON	OFF	OFF

Remarks: You must be in the cdma2000, W-CDMA, or 1xEV-DO mode to use this command. Use INSTRument:SElect to set the mode.

### Spectrum Emission Mask—Region Stop Absolute Power Limit

cdma2000, W-CDMA mode

```
[ :SENSe] :SEMAsk:REGion[n] :LIST:STOP:ABSolute
<abs_power>, <abs_power>, <abs_power>, <abs_power>, <abs_power>
```

```
[ :SENSe] :SEMAsk:REGion[n] :LIST:STOP:ABSolute?
```

1xEV-DO mode

```
[ :SENSe] :SEMAsk:REGion:LIST:STOP:ABSolute
<abs_power>, <abs_power>, <abs_power>, <abs_power>, <abs_power>
```

```
[ :SENSe] :SEMAsk:REGion:LIST:STOP:ABSolute?
```

Set an absolute power level for each region stop limit. The list must contain five (5) entries. If there is more than one region, the region closest to the carrier channel comes first in the list.

The fail condition is set by [:SENS]:SEM:REG[n]:LIST:TEST for each region test.

You can turn off (not use) specific regions with [:SENS]:SEM:REG[n]:LIST:STAT.

The query returns the five (5) sets of the real values currently set to the region stop absolute power limits.

REGion[n] n=1 is the base station test and n=2 is the mobile test.  
The default is the base station test (1). (cdma2000,  
W-CDMA mode only)

Factory Preset and \*RST:

Mode	Variant	Region A	Region B	Region C	Region D	Region E
cdma2000	BTS	-86.00 dBm	-41.00 dBm	-98.00 dBm	-57.00 dBm	-50.00 dBm
	MS	-41.00 dBm	-67.00 dBm	-79.00 dBm	-71.00 dBm	-50.00 dBm
W-CDMA	n/a	-50.00 dBm	-50.00 dBm	-50.00 dBm	-50.00 dBm	-50.00 dBm
1xEV-DO	n/a	-50.00 dBm	-50.00 dBm	-50.00 dBm	-50.00 dBm	-50.00 dBm

Range: -200.00 dBm to 50.00 dBm

Unit: dBm

Remarks: You must be in the cdma2000, W-CDMA, or 1xEV-DO mode to use this command. Use INSTRUMENT:SElect to set the mode.

### Spectrum Emission Mask—Couple Region Stop Absolute Power Limit

**[ :SENSE ] :SEMAsk:REGion[n] :LIST:STOP:ABSolute:COUple  
OFF | ON | 0 | 1 { , OFF | ON | 0 | 1 }**

**[ :SENSE ] :SEMAsk:REGion[n] :LIST:STOP:ABSolute:COUple?**

Define whether or not to couple the region stop absolute power limit to the region start absolute power limit for each region.

You can turn off (not use) specific regions with  
[:SENS]:SEM:REG[n]:LIST:STAT.

REGion[n] n=1 is the base station test and n=2 is the mobile test.  
The default is the base station test (1). (cdma2000,  
W-CDMA mode only)

Factory Preset:

Mode	Region A	Region B	Region C	Region D	Region E
cdma2000	ON	ON	ON	ON	ON
W-CDMA	ON	ON	ON	ON	ON
1xEV-DO	ON	ON	ON	ON	ON

Remarks: You must be in the cdma2000, W-CDMA, or 1xEV-DO mode to use this command. Use INSTRUMENT:SElect to set the mode.

## Spectrum Emission Mask—Region Stop Relative Power Limit

cdma2000, W-CDMA mode

```
[ :SENSe] :SEMAsk:REGion [n] :LIST:STOP:RCARrier
<rel_power>, <rel_power>, <rel_power>, <rel_power>, <rel_power>
```

```
[ :SENSe] :SEMAsk:REGion [n] :LIST:STOP:RCARrier?
```

1xEV-DO mode

```
[ :SENSe] :SEMAsk:REGion:LIST:STOP:RCARrier
<rel_power>, <rel_power>, <rel_power>, <rel_power>, <rel_power>
```

```
[ :SENSe] :SEMAsk:REGion:LIST:STOP:RCARrier?
```

Set a relative power level for each region stop limit. The list must contain five (5) entries. If there is more than one region, the region closest to the carrier channel comes first in the list.

The fail condition is set by [:SENS]:SEM:REG[n]:LIST[m]:TEST for each region.

You can turn off (not use) specific regions with [:SENS]:SEM:REG[n]:LIST:STAT.

The query returns the five (5) sets of the real values currently set to the region stop relative power limits.

REGion[n]      n=1 is the base station test and n=2 is the mobile test.  
The default is the base station test (1). (cdma2000, W-CDMA mode only)

Factory Preset:

Mode	Region A	Region B	Region C	Region D	Region E
cdma2000	-30.00 dB	-30.00 dB	-30.00 dB	-30.00 dB	-30.00 dB
W-CDMA	-30.00 dB	-30.00 dB	-30.00 dB	-30.00 dB	-30.00 dB
1xEV-DO	-30.00 dB	-30.00 dB	-30.00 dB	-30.00 dB	-30.00 dB

Range:            -150.00 dBm to 50.00 dB

Default Unit:    dB

Remarks:        You must be in the cdma2000, W-CDMA, or 1xEV-DO mode to use this command. Use INSTRument:SElect to set the mode.

## Spectrum Emission Mask—Couple Region Stop Relative Power Limit

cdma2000, W-CDMA mode

```
[ :SENSe ] :SEMAsk:REGion[n] :LIST:STOP:RCARrier:COUPle
OFF | ON | 0 | 1, OFF | ON | 0 | 1, OFF | ON | 0 | 1, OFF | ON | 0 | 1, OFF | ON | 0 | 1
```

```
[ :SENSe ] :SEMAsk:REGion[n] :LIST:STOP:RCARrier:COUPle?
```

1xEV-DO mode

```
[ :SENSe ] :SEMAsk:REGion:LIST:STOP:RCARrier:COUPle
OFF | ON | 0 | 1, OFF | ON | 0 | 1, OFF | ON | 0 | 1, OFF | ON | 0 | 1, OFF | ON | 0 | 1
```

```
[ :SENSe ] :SEMAsk:REGion:LIST:STOP:RCARrier:COUPle?
```

Define whether or not to couple the region stop relative power limit to the region start relative power limit for each region.

You can turn off (not use) specific regions with

```
[ :SENS ] :SEM:REG[n]:LIST:STAT.
```

REGion[n]      n=1 is the base station test and n=2 is the mobile test.  
The default is the base station test (1). (cdma2000,  
W-CDMA mode only)

Factory Preset:

Mode	Region A	Region B	Region C	Region D	Region E
cdma2000	ON	ON	ON	ON	ON
W-CDMA	ON	ON	ON	ON	ON
1xEV-DO	ON	ON	ON	ON	ON

Remarks:      You must be in the cdma2000, W-CDMA, or 1xEV-DO mode to use this command. Use INSTRument:SElect to set the mode.

### Spectrum Emission Mask—Region Limit Test Fail Condition

cdma2000, W-CDMA mode

```
[ :SENSe ] :SEMAsk:REGion[n] :LIST:TEST
ABSolute | AND | OR | RELative, ABSolute | AND | OR | RELative,
ABSolute | AND | OR | RELative, ABSolute | AND | OR | RELative,
ABSolute | AND | OR | RELative
```

```
[ :SENSe ] :SEMAsk:REGion[n] :LIST:TEST?
```

1xEV-DO mode

```
[ :SENSe ] :SEMAsk:REGion:LIST:TEST
ABSolute | AND | OR | RELative, ABSolute | AND | OR | RELative,
ABSolute | AND | OR | RELative, ABSolute | AND | OR | RELative,
ABSolute | AND | OR | RELative
```

```
[ :SENSe ] :SEMAsk:REGion:LIST:TEST?
```

Define one of the fail conditions for each region limit test to be done. The absolute or relative test limit value for each region is set by [:SENS]:SEM:REG[n]:LIST:ABS or [:SENS]:SEM:REG[n]:LIST:RCAR.

You can turn off (not use) specific regions with [:SENS]:SEM:REG[n]:LIST[m]:STAT.

REGion[n]      n=1 is the base station test and n=2 is the mobile test. The default is the base station test (1). (cdma2000, W-CDMA mode only)

The fail condition that can be set for each region test include:

- AND - Tests the measurement result for a region against both the absolute power limit and the relative power limit. If it fails, then returns a failure for that measurement test.
- ABSolute - Tests the measurement result for a region against the absolute power limit. If it fails, then returns a failure for that measurement test.
- OR - Tests the measurement result for a region against the absolute power limit OR the relative power limit. If either test fails, then returns a failure for that measurement test.
- RELative - Tests the measurement result for a region against the relative power limit. If it fails, then returns a failure for that measurement test.

Factory Preset:

Mode	Region A	Region B	Region C	Region D	Region E
cdma2000	ABS	ABS	ABS	ABS	ABS
W-CDMA	ABS	ABS	ABS	ABS	ABS
1xEV-DO	ABS	ABS	ABS	ABS	ABS

Remarks:      You must be in the cdma2000, W-CDMA, or 1xEV-DO mode to use this command. Use INSTRument:SElect to set the mode.

### Spectrum Emission Mask—Spectrum Segment

**[:SENSe]:SEMAsk:SEGment OFFSet | REGion**

**[:SENSe]:SEMAsk:SEGment?**

Set the frequency spectrum measurement segment to either the offset channels with relative frequencies or the regions with absolute frequencies.

Factory Preset: OFFset

Remarks: You must be in the cdma2000, W-CDMA, or 1xEV-DO mode to use this command. Use INSTRument:SElect to set the mode.

### Spectrum Emission Mask—Measurement Mode

**[ :SENSe ] :SEMAsk :SEGment :TYPE ACPr | SEMAsk**

**[ :SENSe ] :SEMAsk :SEGment :TYPE?**

Set the measurement mode to either the SEM (spectrum emission mask) mode or the ACP (adjacent channel power) mode.

Factory Preset: SEMAsk

Remarks: You must be in the 1xEV-DO mode to use this command. Use INSTRument:SElect to set the mode.

History: PSA:  
Added in version A.02.00  
E4406A:  
Added in version A.05.00

### Spectrum Emission Mask—Measurement Interval

**[ :SENSe ] :SEMAsk :SWEep :TIME <time> | <no. of chips>**

**[ :SENSe ] :SEMAsk :SWEep :TIME?**

Specify the time length in  $\mu\text{s}$  or number of chips, for the measurement interval that is the data acquisition time for each bin.

Factory Preset: 1 ms

182.3  $\mu\text{s}$  or 224 chips (for 1xEV-DO)

Range: 100  $\mu\text{s}$  to 10 ms  
10.0  $\mu\text{s}$  to 10.0 ms or 12.3 to 12300 chips (for 1xEV-DO)

Default Unit: seconds

Remarks: You must be in the cdma2000, W-CDMA, or 1xEV-DO mode to use this command. Use INSTRument:SElect to set the mode.

### Spectrum Emission Mask—Measurement Offset

**[ :SENSe ] :SEMAsk :SWEep :TIME :OFFSet <time> | <no. of chips>**

**[ :SENSe ] :SEMAsk :SWEep :TIME :OFFSet?**



Specify the time length in  $\mu\text{s}$  or no. of chips offset from the measurement trigger.

Factory Preset: 325.5  $\mu\text{s}$  or 400 chips

Range: 0.0  $\mu\text{s}$  to 1667.0  $\mu\text{s}$  or 0 to 2048 chips

Default Unit: seconds

Remarks: You must be in the 1xEV-DO mode to use this command. Use INSTRUMENT:SElect to set the mode.

History: PSA:  
Added in version A.02.00  
  
E4406A:  
Added in version A.05.00

### Spectrum Emission Mask—Trigger Source

**[ :SENSE ] :SEMAsk:TRIGger:SOURce**  
**EXTernal [1] | EXTernal2 | FRAME | IMMEDIATE | LINE**  
**[ :SENSE ] :SEMAsk:TRIGger:SOURce?**

Select one of the trigger sources used to control the data acquisitions.

EXTernal 1 – front panel external trigger input

EXTernal 2 – rear panel external trigger input

FRAME – internal frame trigger

IMMEDIATE – the next data acquisition is immediately taken, capturing the signal asynchronously (also called free run).

LINE – power line

Factory Preset: IMMEDIATE

Remarks: You must be in the cdma2000, W-CDMA, or 1xEV-DO mode to use this command. Use INSTRUMENT:SElect to set the mode.

### Spectrum Emission Mask—Power Reference

**[ :SENSE ] :SEMAsk:TYPE PSDRef | TPreF**  
**[ :SENSE ] :SEMAsk:TYPE?**

Set the power measurement reference type. This allows you to make absolute and relative power measurements of either total power or the power normalized to the measurement bandwidth.

PSDRef - the power spectral density is used as the power reference

TPRef - the total power is used as the power reference

Factory Preset: TPRef

Remarks: You must be in the cdma2000, W-CDMA, 1xEV-DO mode to use this command. Use INSTRument:SElect to set the mode.

## Spectrum (Frequency-Domain) Measurement

Commands for querying the spectrum measurement results and for setting to the default values are found in the “[MEASure Group of Commands](#)” on page 375. The equivalent front panel keys for the parameters described in the following commands, are found under the **Meas Setup** key, after the **Spectrum (Freq Domain)** measurement has been selected from the **MEASURE** key menu.

### Spectrum—Data Acquisition Packing

```
[ :SENSe ] :SPECTrum:ACQuisition:PACKing
AUTO | LONG | MEDium | SHORT
```

```
[ :SENSe ] :SPECTrum:ACQuisition:PACKing?
```

Select the amount of data acquisition packing. This is an advanced control that normally does not need to be changed.

Factory Preset: AUTO

Remarks: To use this command for E4406A, the appropriate mode should be selected with INSTRUMENT:SElect.

For PSA you must be in the Basic, cdmaOne, cdma2000, 1xEV-DO, W-CDMA, GSM, EDGE, NADC, or PDC mode to use this command. Use INSTRUMENT:SElect to set the mode.

### Spectrum—ADC Dither

```
[ :SENSe ] :SPECTrum:ADC:DITHer [ :STATe ] AUTO | ON | OFF | 2 | 1 | 0
```

```
[ :SENSe ] :SPECTrum:ADC:DITHer [ :STATe ] ?
```

Turn the ADC dither on or off. This is an advanced control that normally does not need to be changed.

Factory Preset: AUTO

Remarks: To use this command for E4406A, the appropriate mode should be selected with INSTRUMENT:SElect.

For PSA you must be in the Basic, cdmaOne, cdma2000, 1xEV-DO, W-CDMA, GSM, EDGE, NADC, or PDC mode to use this command. Use INSTRUMENT:SElect to set the mode.

### Spectrum—ADC Range

E4406A

```
[ :SENSe ] :SPECTrum:ADC:RANGe
```

**AUTO | APEak | APLock | M6 | P0 | P6 | P12 | P18 | P24**

PSA

**[ :SENSe ] :SPECTrum:ADC:RANGe**

**AUTO | APEak | APLock | NONE | P0 | P6 | P12 | P18**

**[ :SENSe ] :SPECTrum:ADC:RANGe?**

Select the range for the gain-ranging that is done in front of the ADC. This is an advanced control that normally does not need to be changed. Auto peak ranging is the default for this measurement. If you are measuring a CW signal please see the description below.

- **AUTO** - automatic range  
For FFT spectrums - auto ranging should not be used. An exception to this would be if you know that your signal is “bursty”. Then you might use auto to maximize the time domain dynamic range as long as you are not very interested in the FFT data.
- **Auto Peak (APEak)** - automatically peak the range  
For CW signals, the default of auto-peak ranging can be used, but a better FFT measurement of the signal can be made by selecting one of the manual ranges that are available: M6, P0 - P24. Auto peaking can cause the ADC range gain to move monotonically down during the data capture. This movement should have negligible effect on the FFT spectrum, but selecting a manual range removes this possibility. Note that if the CW signal being measured is close to the auto-ranging threshold, the noise floor may shift as much as 6 dB from sweep to sweep.
- **Auto Peak Lock (APLock)** - automatically peak lock the range  
For CW signals, auto-peak lock ranging may be used. It will find the best ADC measurement range for this particular signal and will not move the range as auto-peak can. Note that if the CW signal being measured is close to the auto-ranging threshold, the noise floor may shift as much as 6 dB from sweep to sweep. For “bursty” signals, auto-peak lock ranging should not be used. The measurement will fail to operate, since the wrong (locked) ADC range will be chosen often and overloads will occur in the ADC.
- **NONE** - (PSA) turns off any auto-ranging without making any changes to the current setting.
- **M6** - (E4406A) manually selects an ADC range that subtracts 6 dB of fixed gain across the range. Manual ranging is best for CW signals.
- **P0 to P18** - (PSA) manually selects ADC ranges that add 0 to 18 dB of fixed gain across the range. Manual ranging is best for CW signals.

- P0 to 24 - (E4406A) manually selects ADC ranges that add 0 to 24 dB of fixed gain across the range. Manual ranging is best for CW signals.

Factory Preset: APEak

Remarks: To use this command for E4406A, the appropriate mode should be selected with INSTRUMENT:SElect.

For PSA you must be in the Basic, cdmaOne, cdma2000, 1xEV-DO, W-CDMA, GSM, EDGE, NADC, or PDC mode to use this command. Use INSTRUMENT:SElect to set the mode.

### Spectrum—Average Clear

**[ :SENSe ] :SPECTrum:AVERAge:CLEar**

The average data is cleared and the average counter is reset.

Remarks: To use this command for E4406A, the appropriate mode should be selected with INSTRUMENT:SElect.

For PSA you must be in the Basic, cdmaOne, cdma2000, 1xEV-DO, W-CDMA, GSM, EDGE, NADC, or PDC mode to use this command. Use INSTRUMENT:SElect to set the mode.

### Spectrum—Number of Averages

**[ :SENSe ] :SPECTrum:AVERAge:COUNT <integer>**

**[ :SENSe ] :SPECTrum:AVERAge:COUNT?**

Set the number of ‘sweeps’ that will be averaged. After the specified number of ‘sweeps’ (average counts), the averaging mode (terminal control) setting determines the averaging action.

Factory Preset: 25

Range: 1 to 10,000

Remarks: To use this command for E4406A, the appropriate mode should be selected with INSTRUMENT:SElect.

For PSA you must be in the Basic, cdmaOne, cdma2000, 1xEV-DO, W-CDMA, GSM, EDGE, NADC, or PDC mode to use this command. Use INSTRUMENT:SElect to set the mode.

### Spectrum—Averaging State

**[ :SENSe ] :SPECTrum:AVERAge [ :STATe ] OFF | ON | 0 | 1**

**[ :SENSe ] :SPECTrum:AVERAge [ :STATe ] ?**

Turn averaging on or off.

Factory Preset: ON

Remarks: To use this command for E4406A, the appropriate mode should be selected with INSTRUMENT:SElect.

For PSA you must be in the Basic, cdmaOne, cdma2000, 1xEV-DO, W-CDMA, GSM, EDGE, NADC, or PDC mode to use this command. Use INSTRUMENT:SElect to set the mode.

### Spectrum—Averaging Mode

**[ :SENSe ] :SPECTrum:AVERAge:TCONtrol EXPonential | REPeat**

**[ :SENSe ] :SPECTrum:AVERAge:TCONtrol ?**

Select the type of termination control used for the averaging function. This determines the averaging action after the specified number of 'sweeps' (average count) is reached.

EXPonential - Each successive data acquisition after the average count is reached, is exponentially weighted and combined with the existing average.

REPeat - After reaching the average count, the averaging is reset and a new average is started.

Factory Preset: EXPonential

Remarks: To use this command for E4406A, the appropriate mode should be selected with INSTRUMENT:SElect.

For PSA you must be in the Basic, cdmaOne, cdma2000, 1xEV-DO, W-CDMA, GSM, EDGE, NADC, or PDC mode to use this command. Use INSTRUMENT:SElect to set the mode.

### Spectrum—Averaging Type

**[ :SENSe ] :SPECTrum:AVERAge:TYPE  
LOG | MAXimum | MINimum | RMS | SCALar**

**[ :SENSe ] :SPECTrum:AVERAge:TYPE?**

Select the type of averaging.

LOG – The log of the power is averaged. (This is also known as video averaging.)

MAXimum – The maximum values are retained.

MINimum – The minimum values are retained.

RMS – The power is averaged, providing the rms of the voltage.

SCALar – The voltage is averaged.

Factory Preset: LOG

Remarks: To use this command for E4406A, the appropriate mode should be selected with INSTRUMENT:SElect.

For PSA you must be in the Basic, cdmaOne, cdma2000, 1xEV-DO, W-CDMA, GSM, EDGE, NADC, or PDC mode to use this command. Use INSTRUMENT:SElect to set the mode.

### Spectrum— Select Pre-FFT Bandwidth

**[ :SENSe ] :SPECTrum: BANDwidth | BWIDth: IF: AUTO OFF | ON | 0 | 1**

**[ :SENSe ] :SPECTrum: BANDwidth | BWIDth: IF: AUTO?**

Select auto or manual control of the pre-FFT BW.

Factory Preset: AUTO, 1.55 MHz

Remarks: To use this command for E4406A, the appropriate mode should be selected with INSTRUMENT:SElect.

For PSA you must be in the Basic, cdmaOne, cdma2000, 1xEV-DO, W-CDMA, GSM, EDGE, NADC, or PDC mode to use this command. Use INSTRUMENT:SElect to set the mode.

Front Panel

Access: **Measure, Spectrum, Meas Setup, More, Advanced, Pre-FFT BW.**

### Spectrum — IF Flatness Corrections

**[ :SENSe ] :SPECTrum: BANDwidth | BWIDth: IF: FLATness OFF | ON | 0 | 1**

**[ :SENSe ] :SPECTrum: BANDwidth | BWIDth: IF: FLATness?**

Turns IF flatness corrections on and off.

Factory Preset: ON

Remarks: To use this command for E4406A, the appropriate mode should be selected with INSTRUMENT:SElect.

For PSA you must be in the Basic, cdmaOne, cdma2000, 1xEV-DO, W-CDMA, GSM, EDGE, NADC, or PDC mode to use this command. Use INSTRument:SElect to set the mode.

Front Panel

Access: **Measure, Spectrum, Meas Setup, More, Advanced, Pre-FFT BW**

### Spectrum—Pre-ADC Bandpass Filter

**[ :SENSe ] :SPECTrum: BANDwidth | BWIDth: PADC OFF | ON | 0 | 1**

**[ :SENSe ] :SPECTrum: BANDwidth | BWIDth: PADC ?**

Turn the pre-ADC bandpass filter on or off. This is an advanced control that normally does not need to be changed.

Remarks: To use this command for E4406A, the appropriate mode should be selected with INSTRument:SElect.

For PSA you must be in the Basic, cdmaOne, cdma2000, 1xEV-DO, W-CDMA, GSM, EDGE, NADC, or PDC mode to use this command. Use INSTRument:SElect to set the mode.

### Spectrum—Pre-FFT BW

**[ :SENSe ] :SPECTrum: BANDwidth | BWIDth: PFFT [ :SIZE ] <freq>**

**[ :SENSe ] :SPECTrum: BANDwidth | BWIDth: PFFT [ :SIZE ] ?**

Set the pre-FFT bandwidth. This is an advanced control that normally does not need to be changed.

Frequency span, resolution bandwidth, and the pre-FFT bandwidth settings are normally coupled. If you are not auto-coupled, there can be combinations of these settings that are not valid.

Factory Preset: 1.55 MHz

1.25 MHz for cdmaOne

155.0 kHz, for iDEN mode (E4406A)

Range: 1 Hz to 10.0 MHz

Remarks: To use this command for E4406A, the appropriate mode should be selected with INSTRument:SElect.

For PSA you must be in the Basic, cdmaOne, cdma2000, 1xEV-DO, W-CDMA, GSM, EDGE, NADC, or PDC mode to use this command. Use INSTRument:SElect to



set the mode.

### Spectrum—Pre-FFT BW Filter Type

```
[ :SENSE ] :SPECTrum: BANDwidth | BWIDth: PFFT: TYPE FLAT | GAUSSian
```

```
[ :SENSE ] :SPECTrum: BANDwidth | BWIDth: PFFT: TYPE?
```

Select the type of pre-FFT filter that is used. This is an advanced control that normally does not need to be changed.

Flat top (FLAT)- a filter with a flat amplitude response, which provides the best amplitude accuracy.

GAUSSian - a filter with Gaussian characteristics, which provides the best pulse response.

Factory Preset: FLAT

Remarks: To use this command for E4406A, the appropriate mode should be selected with INSTRUMENT:SElect.

For PSA you must be in the Basic, cdmaOne, cdma2000, 1xEV-DO, W-CDMA, GSM, EDGE, NADC, or PDC mode to use this command. Use INSTRUMENT:SElect to set the mode.

### Spectrum—Resolution BW

```
[ :SENSE ] :SPECTrum: BANDwidth | BWIDth [ :RESolution ] <freq>
```

```
[ :SENSE ] :SPECTrum: BANDwidth | BWIDth [ :RESolution ] ?
```

Set the resolution bandwidth for the FFT. This is the bandwidth used for resolving the FFT measurement. It is not the pre-FFT bandwidth. This value is ignored if the function is auto-coupled.

Frequency span, resolution bandwidth, and the pre-FFT bandwidth settings are normally coupled. If you are not auto-coupled, there can be combinations of these settings that are not valid.

Factory Preset: 20.0 kHz

250.0 Hz, for iDEN mode (E4406A)

Range: 0.10 Hz to 3.0 MHz

Remarks: To use this command for E4406A, the appropriate mode should be selected with INSTRUMENT:SElect.

For PSA you must be in the Basic, cdmaOne, cdma2000, 1xEV-DO, W-CDMA, GSM, EDGE, NADC, or PDC mode to use this command. Use INSTRUMENT:SElect to set the mode.

## Spectrum—Resolution BW Auto

```
[ :SENSe ] :SPECTrum: BANDwidth | BWIDth [ :RESolution ] :AUTO  
OFF | ON | 0 | 1
```

```
[ :SENSe ] :SPECTrum: BANDwidth | BWIDth [ :RESolution ] :AUTO?
```

Select auto or manual control of the resolution BW. The automatic mode couples the resolution bandwidth setting to the frequency span.

Factory Preset: ON

OFF, for iDEN mode (E4406A)

Remarks: To use this command for E4406A, the appropriate mode should be selected with INSTRUMENT:SElect.

For PSA you must be in the Basic, cdmaOne, cdma2000, W-CDMA, GSM, EDGE, NADC, or PDC mode to use this command. Use INSTRUMENT:SElect to set the mode.

## Decimation of Spectrum Display

```
[ :SENSe ] :SPECTrum: DECimate [ :FACTOR ] <integer>
```

```
[ :SENSe ] :SPECTrum: DECimate [ :FACTOR ] ?
```

Sets the amount of data decimation done by the hardware and/or the software. Decimation by *n* keeps every *n*th sample, throwing away each of the remaining samples in the group of *n*. For example, decimation by 3 keeps every third sample, throwing away the two in between. Similarly, decimation by 5 keeps every fifth sample, throwing away the four in between.

Using zero (0) decimation selects the automatic mode. The measurement will then automatically choose decimation by “1” or “2” as is appropriate for the bandwidth being used.

This is an advanced control that normally does not need to be changed.

Factory Preset: 0

Range: 0 to 1,000, where 0 sets the function to automatic

Remarks: To use this command for E4406A, the appropriate mode should be selected with INSTRUMENT:SElect.

For PSA you must be in the Basic, cdmaOne, cdma2000, 1xEV-DO, W-CDMA, GSM, EDGE, NADC, or PDC mode to use this command. Use INSTRUMENT:SElect to set the mode.

History: E4406A:  
Version A.02.00 or later

### Spectrum—FFT Length

**[ :SENSe ] :SPECTrum:FFT:LENGth <integer>**

**[ :SENSe ] :SPECTrum:FFT:LENGth?**

Set the FFT length. This value is only used if length control is set to manual. The value must be greater than or equal to the window length value. Any amount greater than the window length is implemented by zero-padding. This is an advanced control that normally does not need to be changed.

Factory Preset: 706

Range: min, depends on the current setting of the spectrum window length  
max, 1,048,576

Remarks: To use this command for E4406A, the appropriate mode should be selected with INSTRUMENT:SElect.

For PSA you must be in the Basic, cdmaOne, cdma2000, 1xEV-DO, W-CDMA, GSM, EDGE, NADC, or PDC mode to use this command. Use INSTRUMENT:SElect to set the mode.

History: E4406A:  
Short form changed from LENGth to LENGth, A.03.00

### Spectrum—FFT Length Auto

**[ :SENSe ] :SPECTrum:FFT:LENGth:AUTO OFF | ON | 0 | 1**

**[ :SENSe ] :SPECTrum:FFT:LENGth:AUTO?**

Select auto or manual control of the FFT and window lengths.

This is an advanced control that normally does not need to be changed.

On - the window lengths are coupled to resolution bandwidth, window type (FFT), pre-FFT bandwidth (sample rate) and SENSE:SPECTrum:FFT:RBWPoints.

Off - lets you set SENSE:SPECTrum:FFT:LENGth and SENSE:SPECTrum:FFT:WINDow:LENGth.

Factory Preset: ON

Remarks: To use this command for E4406A, the appropriate mode should be selected with INSTRUMENT:SElect.

For PSA you must be in the Basic, cdmaOne, cdma2000, 1xEV-DO, W-CDMA, GSM, EDGE, NADC, or PDC mode to use this command. Use INSTRument:SElect to set the mode.

History: E4406A:  
Short form changed from LENgth to LENGth, A.03.00

### Spectrum—FFT Minimum Points in Resolution BW

**[[:SENSe]:SPECTrum:FFT:RBWPoints <real>**

**[[:SENSe]:SPECTrum:FFT:RBWPoints?**

Set the minimum number of data points that will be used inside the resolution bandwidth. The value is ignored if length control is set to manual. This is an advanced control that normally does not need to be changed.

Factory Preset: 1.30

Range: 0.1 to 100

Remarks: To use this command for E4406A, the appropriate mode should be selected with INSTRument:SElect.

For PSA you must be in the Basic, cdmaOne, cdma2000, 1xEV-DO, W-CDMA, GSM, EDGE, NADC, or PDC mode to use this command. Use INSTRument:SElect to set the mode.

### Spectrum—Window Delay

**[[:SENSe]:SPECTrum:FFT:WINDow:DELay <real>**

**[[:SENSe]:SPECTrum:FFT:WINDow:DELay?**

Set the FFT window delay to move the FFT window from its nominal position of being centered within the time capture. This function is not available from the front panel. It is an advanced control that normally does not need to be changed.

Factory Preset: 0

Range: -10.0 to +10.0s

Default Unit: seconds

Remarks: To use this command for E4406A, the appropriate mode should be selected with INSTRument:SElect.

For PSA you must be in the Basic, cdmaOne, cdma2000, 1xEV-DO, W-CDMA, GSM, EDGE, NADC, or PDC

mode to use this command. Use INSTRument:SElect to set the mode.

### Spectrum—Window Length

**[ :SENSe] :SPECTrum:FFT:WINDow:LENGth <integer>**

**[ :SENSe] :SPECTrum:FFT:WINDow:LENGth?**

Set the FFT window length. This value is only used if length control is set to manual. This is an advanced control that normally does not need to be changed.

Factory Preset: 706

Range: 8 to 1,048,576

Remarks: To use this command for E4406A, the appropriate mode should be selected with INSTRument:SElect.

For PSA you must be in the Basic, cdmaOne, cdma2000, 1xEV-DO, W-CDMA, GSM, EDGE, NADC, or PDC mode to use this command. Use INSTRument:SElect to set the mode.

History: E4406A:  
Short form changed from LENGth to LENGth, A.03.00

### Spectrum—FFT Window

**[ :SENSe] :SPECTrum:FFT:WINDow [ :TYPE]**

**BH4Tap | BLACkman | FLATtop | GAUSSian | HAMMING | HANNing | KB70 | KB90 | KB110 | UNIFORM**

**[ :SENSe] :SPECTrum:FFT:WINDow [ :TYPE] ?**

Select the FFT window type.

BH4Tap - Blackman Harris with 4 taps

BLACkman - Blackman

FLATtop - flat top, the default (for high amplitude accuracy)

GAUSSian - Gaussian with alpha of 3.5

HAMMING - Hamming

HANNing - Hanning

KB70, 90, and 110 - Kaiser Bessel with sidelobes at -70, -90, or -110 dBc

UNIFORM - no window is used. (This is the unity response.)

Factory Preset: FLATtop

Remarks: This selection affects the acquisition point quantity and the FFT size, based on the resolution bandwidth selected.

To use this command for E4406A, the appropriate mode should be selected with INSTRUMENT:SElect.

For PSA you must be in the Basic, cdmaOne, cdma2000, 1xEV-DO, W-CDMA, GSM, EDGE, NADC, or PDC mode to use this command. Use INSTRUMENT:SElect to set the mode.

### Spectrum—Frequency Span

**[ :SENSe ] :SPECTrum:FREQuency:SPAN <freq>**

**[ :SENSe ] :SPECTrum:FREQuency:SPAN?**

Set the frequency span to be measured.

Factory Preset: 1.0 MHz

100.0 kHz for iDEN mode (E4406A)

Range: 10 Hz to 10.0 MHz (15 MHz when Service mode is selected)

Default Unit: Hz

Remarks: The actual measured span will generally be slightly wider due to the finite resolution of the FFT.

To use this command for E4406A, the appropriate mode should be selected with INSTRUMENT:SElect.

For PSA you must be in the Basic, cdmaOne, cdma2000, 1xEV-DO, W-CDMA, GSM, EDGE, NADC, or PDC mode to use this command. Use INSTRUMENT:SElect to set the mode.

### Spectrum—Sweep (Acquisition) Time

**[ :SENSe ] :SPECTrum:SWEep:TIME[:VALue] <time>**

**[ :SENSe ] :SPECTrum:SWEep:TIME?**

Set the sweep (measurement acquisition) time. It is used to specify the length of the time capture record. If the value you specify is less than the capture time required for the specified span and resolution bandwidth, the value is ignored. The value is set at its auto value when auto is selected. This is an advanced control that normally does not

need to be changed.

Factory Preset: 188.0  $\mu$ s

15.059 ms, for iDEN mode (E4406A)

Range: 100 ns to 10 s

Default Unit: seconds

Remarks: To use this command for E4406A, the appropriate mode should be selected with INSTRUMENT:SElect.

For PSA you must be in the Basic, cdmaOne, cdma2000, 1xEV-DO, W-CDMA, GSM, EDGE, NADC, or PDC mode to use this command. Use INSTRUMENT:SElect to set the mode.

### Spectrum—Sweep (Acquisition) Time Auto

**[ :SENSE ] :SPECTrum:SWEep:TIME:AUTO OFF | ON | 0 | 1**

**[ :SENSE ] :SPECTrum:SWEep:TIME:AUTO**

Select auto or manual control of the sweep (acquisition) time. This is an advanced control that normally does not need to be changed.

AUTO - couples the Sweep Time to the Frequency Span and Resolution BW

Manual - the Sweep Time is uncoupled from the Frequency Span and Resolution BW.

Factory Preset: AUTO

Remarks: To use this command for E4406A, the appropriate mode should be selected with INSTRUMENT:SElect.

For PSA you must be in the Basic, cdmaOne, cdma2000, 1xEV-DO, W-CDMA, GSM, EDGE, NADC, or PDC mode to use this command. Use INSTRUMENT:SElect to set the mode.

### Spectrum—Trigger Source

**[ :SENSE ] :SPECTrum:TRIGger:SOURce  
EXTernal [1] | EXTernal2 | FRAME | IF | LINE | IMMEDIATE  
| RFBurst**

**[ :SENSE ] :SPECTrum:TRIGger:SOURce?**

Select the trigger source used to control the data acquisitions.

EXTernal1 - front panel external trigger input

EXTernal2 - rear panel external trigger input

FRAMe - internal frame timer from front panel input

IF - internal IF envelope (video) trigger

LINE - internal line trigger

IMMEDIATE - the next data acquisition is immediately taken (also called free run)

RFBurst - wideband RF burst envelope trigger that has automatic level control for periodic burst signals

Factory Preset: IMMEDIATE (free run)

RFBurst, for GSM, iDEN mode

Remarks: To use this command for E4406A, the appropriate mode should be selected with INSTRUMENT:SElect.

For PSA you must be in the Basic, cdmaOne, cdma2000, 1xEV-DO, W-CDMA, GSM, EDGE, NADC, or PDC mode to use this command. Use INSTRUMENT:SElect to set the mode.



## Terminal Code Domain Measurement

Commands for querying the terminal code domain measurement results and for setting to the default values are found in the “MEASure Group of Commands” on page 375.

### Terminal Code Domain- ADC Range

```
[ :SENSe] :TCDPower:ADC:RANGe
AUTO|APEak|APLock|M6|P0|P6|P12|P18|P24
```

```
[ :SENSe] :TCDPower:ADC:RANGe?
```

Select a ranging function for the ADC gain control. This is an advanced control that normally does not need to be changed.

**AUTO** (automatic ranging) - For FFT spectrums, auto ranging should not be used. An exception to this would be if you know that your signal is “bursty”. Then you might use auto to maximize the time domain dynamic range as long as you are not very interested in the FFT data.

**APEak** (Auto Peak, automatic ranging to the peak signal level) - For CW signals, the default of auto-peak ranging can be used, but a better FFT measurement of the signal can be made by selecting one of the manual ranges available by specifying NONE, or P0 through P18. Auto peaking can cause the ADC gain to monotonically track the ADC ranges during the data capture. This tracking effect should be negligible for the FFT spectrum, but selecting a manual range precludes this possibility. Note that if the CW signal being measured is close to the auto-ranging threshold, the noise floor may shift as much as 6 dB every sweep.

**APLock** (Auto Peak Lock, automatic ranging locked to the peak signal level) - For CW signals, auto-peak lock ranging may be used. It will find the ADC gain most appropriate for this particular signal and will not track the ranges as auto-peak can. Note that if the CW signal being measured is close to the auto-ranging threshold, the noise floor may shift as much as 6 dB every sweep. For “bursty” signals, auto-peak lock ranging should not be used. Since the ADC range may be locked to the wrong range resulting in overloading the ADC, in that case the measurement will fail.

**NONE** (14bit ADC E4406A and PSA) - turns off any auto-ranging without making any changes to the current setting.

**M6** (12bit ADC E4406A) - manually selects an ADC range that subtracts 6 dB from the fixed gain across the range. Manual ranging is best for CW signals.

**P0 thru P18** (14 bit ADC E4406A and PSA) - manually selects one of the ADC ranges that add 0 dB(P0) to 18(P18) dB to the fixed gain across the range. Manual ranging is best for CW signals.

**P0 thru P24** (12bit ADC E4406A) - manually selects one of the ADC

ranges that add 0 dB(P0) to 24(P24) dB to the fixed gain across the range. Manual ranging is best for CW signals.

Key Path	<b>Meas Setup, More 1 of 3, More 2of 3, Advanced</b>
Notes	The range and default value of this command depends on hardware. If use 14bit ADC E4406A or PSA, the range changes and NONE and P0 through P18. And the default value is NONE.
Preset	M6
State Saved	Saved in instrument state.
Range	Auto   Auto Peak   AutoPeakLock   -6dB   0dB   +6dB   +12dB   +18dB   +24dB
Example	TCDP:ADC:RANG AUTO

### Pilot/RRI Channel Definition [Subtype 0/1 only]

**[ :SENSe ] :TCDPower:ACODE:PILot OFF | ON | 0 | 1**

**[ :SENSe ] :TCDPower:ACODE:PILot?**

Key Path	<b>Meas Setup, More 1 of 3, Predefined Active Chan</b>
Notes	This setting is valid with Active Code Chan is set to Combination or Predefined and the physical layer subtype is set to 0/1.
Preset	ON
State Saved	Saved in instrument state.
Range	On   Off
Example	TCDP:ACOD:PIL ON

### ACK Channel Definition [Subtype 0/1 only]

**[ :SENSe ] :TCDPower:ACODE:ACK OFF | ON | 0 | 1**

**[ :SENSe ] :TCDPower:ACODE:ACK?**

Key Path	<b>Meas Setup, More 1 of 3, Predefined Active Chan</b>
Notes	This setting is valid with Active Code Chan is set to Combination or Predefined and the physical layer subtype is set to 0/1.
Preset	ON

State Saved	Saved in instrument state.
Range	On   Off
Example	TCDP:ACOD:ACK ON

### DRC Channel Definition [Subtype 0/1 and 2]

```
[ :SENSE ] :TCDPower:ACODE:DRC OFF | ON | 0 | 1
[ :SENSE ] :TCDPower:ACODE:DRC?
```

Key Path	<b>Meas Setup, More 1 of 3, Predefined Active Chan</b>
Notes	This setting is valid with Active Code Chan is set to Combination or Predefined.
Preset	ON
State Saved	Saved in instrument state.
Range	On   Off
Example	TCDP:ACOD:DRC ON

### Pilot Channel Definition [Subtype 2 only]

```
[ :SENSE ] :TCDPower:ACODE:PILOt OFF | ON | 0 | 1
[ :SENSE ] :TCDPower:ACODE:PILOt?
```

In Subtype 2, Pilot channel and RRI channel are NOT time-multiplexed and these channels are assigned on different walsh code space. Therefore “Pilot Channel Definition” key is valid with Subtype 2 only and the soft key name is different with Subtype 0/1. But SCPI command is same because this command was already used in Subtype 0/1.

Key Path	<b>Meas Setup, More 1 of 3, Predefined Active Chan</b>
Notes	This setting is valid with Active Code Chan is set to Combination or Predefined and the physical layer subtype is set to 2.  This command is same as one for Subtype 0/1. The difference is soft-key label.
Preset	ON
State Saved	Saved in instrument state.
Range	On   Off
Example	TCDP:ACOD:PIL ON

### RRI Channel Definition [Subtype 2 only]

**[ :SENSe ] :TCDPower:ACODE:RRI OFF | ON | 0 | 1**

**[ :SENSe ] :TCDPower:ACODE:RRI?**

Key Path	<b>Meas Setup, More 1 of 3, Predefined Active Chan</b>
Notes	This setting is valid with Active Code Chan is set to Combination or Predefined and the Physical layer subtype is set to 2.
Preset	ON
State Saved	Saved in instrument state.
Range	On   Off
Example	TCDP:ACOD:RRI ON

### ACK/DSC Channel Definition [Subtype 2 only]

**[ :SENSe ] :TCDPower:ACODE:ACKDsc OFF | ON | 0 | 1**

**[ :SENSe ] :TCDPower:ACODE:ACKDsc?**

Key Path	<b>Meas Setup, More 1 of 3, Predefined Active Chan</b>
Notes	This setting is valid with Active Code Chan is set to Combination or Predefined and the physical layer subtype is set to 2.
Preset	ON
State Saved	Saved in instrument state.
Range	On   Off
Example	TCDP:ACOD:ACKD ON

### Auxiliary Pilot Channel Definition [Subtype 2 only]

**[ :SENSe ] :TCDPower:ACODE:APILot OFF | ON | 0 | 1**

**[ :SENSe ] :TCDPower:ACODE:APILot?**

Key Path	<b>Meas Setup, More 1 of 3, Predefined Active Chan</b>
Notes	This setting is valid with Active Code Chan is set to Combination or Predefined and the physical layer subtype is set to 2.
Preset	ON

State Saved	Saved in instrument state.
Range	On   Off
Example	TCDP:ACOD:APIL ON

### Data Channel Definition [Subtype 2 only]

```
[ :SENSe ] :TCDPower:ACODE:DATA:SUB2 B4 | Q4 | Q2 | Q4Q2 | E4E2 | OFF
[ :SENSe ] :TCDPower:ACODE:DATA:SUB2?
```

Key Path	<b>Meas Setup, More 1 of 3, Predefined Active Chan</b>
Notes	This setting is valid with Active Code Chan is set to Combination or Predefined and the physical layer subtype is set to 2.
Preset	B4
State Saved	Saved in instrument state.
Range	B4   Q4   Q2   Q4Q2   E4E2   Off
Example	TCDP:ACOD:DATA:SUB2 B4

### Active Code Chan

```
[ :SENSe ] :TCDPower:ACODE AUTO | COMBination | PREDefined
[ :SENSe ] :TCDPower:ACODE?
```

Active Code Chan: This controls the function to identify which code channels are active.

Auto (Auto Active Channel Detection) means system determines Active Channel(s) automatically. Due to algorithm limitation, when the power level is not stable, Auto won't work well.

Predefined means that user specifies which code channel is active manually.

Combination means the code channel selected by Predefine Active Channel is always regarded as Active and moreover Auto Active Channel detection is performed. If Auto finds other active channels, they are also regarded as Active.

Key Path:	<b>Meas setup, More 1 of 3</b>
Preset:	AUTO
State Saved:	Saved in instrument state.
Range:	Auto   Combination   Predefined

Example: TCDP:ACOD COMB

### Terminal Code Domain Measurement–ADC Range

```
[ :SENSe ] :TCDPower :ADC :RANGE  
AUTO | APEak | APLOCK | NONE | P0 | P6 | P12 | P18 | P24 | M6
```

```
[ :SENSe ] :TCDPower :ADC :RANGE?
```

Select a ranging function for the ADC gain control. This is an advanced control that normally does not need to be changed. If you are measuring a CW signal, see the following description.

- **AUTO** - This is automatic ranging. For FFT spectrums the auto ranging should not be used. An exception to this is if you know that your signal is “bursty,” then you can use auto to maximize the time domain dynamic range as long as you are not very interested in the FFT data.
- **APEak (Auto Peak)** - This is automatic ranging to the peak signal level. For CW signals the default of auto-peak ranging can be used. However, a better FFT measurement of the signal can be made by selecting one of the manual ranges available by specifying NONE, or P0 through P18. Auto peaking can cause the ADC gain to monotonically track the ranges down during the data capture. This tracking effect should be negligible for the FFT spectrum, but selecting a manual range solves this possibility. If the CW signal being measured is close to the auto-ranging threshold, the noise floor may shift as much as 6 dB every sweep.
- **APLOCK (Auto Peak Lock)** - This is automatic ranging locked to the peak signal level. For CW signals, auto-peak lock ranging may be used. It will find the ADC gain most appropriate for this particular signal and will not track the ranges as auto peak can. If the CW signal being measured is close to the auto-ranging threshold, the noise floor may shift as much as 6 dB every sweep. For “bursty” signals, auto peak lock ranging should not be used. Since the ADC range can often be locked to the wrong one (resulting in overloading the ADC) the measurement will fail.
- **NONE** - This turns off any auto-ranging without making any changes to the current setting. This is not applicable for use with an Agilent VSA having a 12-bit ADC Board).
- **P0 through P18, P24, M6** - Manually selects one of the ADC ranges that add 0 dB (P0) to 18 dB (P18) and –6 dB (M6), 24 dB (P24) to the fixed gain across the range. Manual ranging is best for CW signals. M6 and P24 are applicable only for Agilent VSA analyzers having a 14-bit ADC board.

Factory Preset: NONE for Agilent PSA analyzers, including Agilent VSA analyzers with the 14-bit ADC board.

M6 for Agilent VSA analyzers with the 12-bit ADC board.

Remarks: You must be in the 1xEV-DO mode to use this command. Use INSTRUMENT:SElect to set the mode.

### Capture Interval

**[ :SENSE ] :TCDPower:CAPture:TIME <integer>**

**[ :SENSe ] :TCDPower:CAPture:TIME?**

Set the data capture length in slots that will be used in the acquisition.

Key Path:	<b>Meas Setup, More 1 of 3</b>
Preset:	5
State Saved:	Saved in instrument state.
Range:	0 to 32
SCPI Resolution:	1
Step (UP/DOWN):	1
Step (Front Panel):	1
Example:	TCDP:CAPT:TIME 12

### Chip Rate

**[ :SENSe ] :TCDPower:CRATe <freq>**

**[ :SENSe ] :TCDPower:CRATe?**

Select the Chip Rate

Key Path	<b>Meas Setup, More 1 of 3, More 2of 3, Advanced</b>
Preset	1.2288 MHz
State Saved	Saved in instrument state.
Range	1.10592 MHz to 1.35168 MHz
SCPI Resolution	1.0 kHz
Unit/Terminator Keys	Hz   kHz   MHz   GHz
Example	TCDP:CRAT 1.22 MHz

## Trigger Source

```
[[:SENSe]:TCDPower:TRIGger:SOURce EXTernal[1] | EXTernal2 |  
IMMEDIATE | RFBURST | IF | FRAME
```

```
[[:SENSe]:TCDPower:TRIGger:SOURce?
```

Used to select the trigger source for the measurement.

KEY: Free Run (Immediate)      The trigger occurs at the time the data is requested, completely asynchronous to the SCPI: IMMEDIATE:      RF or IF signal. (also called free run)

KEY: Video      An internal IF envelope trigger. It triggers on an absolute threshold level of the signal passed by the SCPI: IF:      IF.

KEY: Ext Front      Activates the external 1 trigger input. Location of the BNC Connector is Front panel. SCPI: EXTERNAL1:      The external trigger must be a signal between 5 and +5 volts.

KEY: Ext Rear      Activates the external 2 trigger input. . Location of the BNC Connector is Front panel. SCPI: EXTERNAL2:      The external trigger must be a signal between 5 and +5 volts.

KEY: RF Burst      An internal wideband RF burst trigger that has an automatic level control for burst signals. It triggers on a level that is relative to the peak of the signal passed by the RF or absolute level. SCPI: RFBURST:

KEY: Frame      Uses the internal periodic timer (used to called 'frame clock') to generate a trigger signal. SCPI: FRAME:

Key Path:      Meas Setup, More 1 of 3, More 2 of 3

Preset:      IMMEDIATE



State Saved: Saved in instrument state.  
 Range: Free Run (Immediate) | Video (IF Envlp) | RF Burst | Ext Front | Ext Rear | Frame  
 Example: TCDP:TRIG:SOUR EXT2

## Spectrum

**[ :SENSe ] :TCDPower:SPECTrum NORMal | INVert**

**[ :SENSe ] :TCDPower:SPECTrum?**

Set a spectrum either to Normal or Inverted for the demodulation related measurements. If set to INVert, the upper and lower spectrums are swapped.

Invert: This function conjugates the spectrum, which is equivalent to taking the negative of the quadrature component in demodulation. The correct setting (Normal or Invert) depends on whether the signal at the input of the instrument has a high or low side mix.

Key Path: **Meas Setup, More 1 of 3, More 2 of 3**  
 Preset: NORMal  
 State Saved: Saved in instrument state.  
 Example: TCDP:SPEC INV

## Terminal Code Domain- Sync Start Slot Number Detection State

**[ :SENSe ] :TCDPower:SSLot:NUMBer <integer>**

**[ :SENSe ] :TCDPower:SSLot:NUMBer?**

**[ :SENSe ] :TCDPower:SSLot [ :STATe ] OFF | ON | 0 | 1**

**[ :SENSe ] :TCDPower:SSLot [ :STATe ] ?**

For the measurement to begin at the first slot, the instrument must depend on trigger timing, or capture timing if the trigger is set to Free Run. If the user employs a trigger, the first slot number measured is determined by the trigger timing.

Alternatively, you can specify the synchronization starting slot number. For example, if the Sync start slot number is set to 5, the analysis starts from slot number 5.0. If Sync Start Slot detection mode is set to Off, the measurement is synchronized based on trigger timing or capture timing.

Key Path: **Meas Setup, More 1 of 3**  
Preset: 0 , OFF  
State Saved: Saved in instrument state.  
Range: 0 to 16 , On | Off  
Step (UP/DOWN): 1  
Example: :TCDP:SSL:NUMB 5  
:TCDP:SSL ON  
Remote Command Turn first slot number detection mode on or off.  
Notes:

### I Long Code Mask

**[ :SENSe ] :TCDPower:SYNC:ILCMask <integer>**

**[ :SENSe ] :TCDPower:SYNC:ILCMask?**

Set the Long Code Mask value for I axis.

Key Path: **Meas Setup, More 1 of 3**  
Preset: 00000000000  
State Saved: Saved in instrument state.  
Range: 00000000000 to 4398046511103  
SCPI Resolution: 1  
Example: TCDP:SYNC:ILCM 1

### Q Long Code Mask

**[ :SENSe ] :TCDPower:SYNC:QLCMask <integer>**

**[ :SENSe ] :TCDPower:SYNC:QLCMask?**

Set the Long Code Mask value for Q axis.

Key Path: **Meas Setup, More 1 of 3**  
Preset: 00000000000  
State Saved: Saved in instrument state.  
Range: 00000000000 to 4398046511103  
SCPI Resolution: 1

Example: TCDP:SYNC:QLCM 1

## Terminal Modulation Accuracy Measurement

Commands for querying the terminal modulation accuracy measurement results and for setting to the default values are found in the “MEASure Group of Commands” on page 375.

### Active Code Chan

```
[ :SENSe ] :TRHO:ACODE AUTO|COMBination|PREDeFined
```

```
[ :SENSe ] :TRHO:ACODE?
```

Active Code Chan: This controls the function to identify which code channels are active. Auto (Auto Active Channel Detection) means system determines Active Channel(s) automatically. When the power levels are unstable, Auto won't work well. Predefined means that user specifies which code channel is active manually.

Combination means the code channel selected by Predefined Active Channel is always regarded as Active and Auto Active Channel detection is performed. If Auto finds other active channels, they are also regarded as Active.

Key Path:	Meas setup
Preset:	AUTO
State Saved:	Saved in instrument state.
Range:	Auto   Combination   Predefined
Example:	TRHO:ACOD COMB

### Pilot Channel Definition

```
[ :SENSe ] :TRHO:ACODE:PILot OFF|ON|0|1
```

```
[ :SENSe ] :TRHO:ACODE:PILot?
```

Key Path	Meas Setup
Notes	This setting is valid with Active Code Chan is set to Combination or Predefined.
Preset	ON
State Saved	Saved in instrument state.
Range	On   Off
Example	TRHO:ACOD:PIL ON

### DRC Channel Definition [Subtype 0/1 and 2]

```
[ :SENSe ] :TRHO:ACODE:DRC OFF | ON | 0 | 1
[ :SENSe ] :TRHO:ACODE:DRC?
```

Key Path	<b>Meas Setup</b>
Notes	This setting is valid with Active Code Chan is set to Combination or Predefined.
Preset	ON
State Saved	Saved in instrument state.
Range	On   Off
Example	TRHO:ACOD:DRC ON

### ACK Channel Definition [Subtype 0/1 only]

```
[ :SENSe ] :TRHO:ACODE:ACK OFF | ON | 0 | 1
[ :SENSe ] :TRHO:ACODE:ACK?
```

Key Path	<b>Meas Setup</b>
Notes	This setting is valid with Active Code Chan is set to Combination or Predefined.
Preset	ON
State Saved	Saved in instrument state.
Range	On   Off
Example	TRHO:ACOD:ACK ON

### Data Channel Definition [Subtype 0/1 only]

```
[ :SENSe ] :TRHO:ACODE:DATA OFF | ON | 0 | 1
[ :SENSe ] :TRHO:ACODE:DATA?
```

Key Path	<b>Meas Setup</b>
Notes	This setting is valid with Active Code Chan is set to Combination or Predefined.
Preset	ON
State Saved	Saved in instrument state.
Range	On   Off

Example TRHO:ACOD:DATA ON

### RRI Channel Definition [Subtype 2 only]

[ :SENSe ] :TRHO:ACODE:RRI OFF | ON | 0 | 1

[ :SENSe ] :TRHO:ACODE:RRI?

Key Path Meas Setup, More 1 of 3, Predefined Active Chan

Notes This setting is valid with Active Code Chan is set to Combination or Predefined and the Physical layer subtype is set to 2.

Preset ON

State Saved Saved in instrument state.

Range On | Off

Example TRHO:ACOD:RRI ON

### ACK/DSC Channel Definition [Subtype 2 only]

[ :SENSe ] :TRHO:ACODE:ACKDsc OFF | ON | 0 | 1

[ :SENSe ] :TRHO:ACODE:ACKDsc?

Key Path Meas Setup, More 1 of 3, Predefined Active Chan

Notes This setting is valid with Active Code Chan is set to Combination or Predefined and the physical layer subtype is set to 2.

Preset ON

State Saved Saved in instrument state.

Range On | Off

Example TRHO:ACOD:ACKD ON

### Auxiliary Pilot Channel Definition [Subtype 2 only]

[ :SENSe ] :TRHO:ACODE:APILot OFF | ON | 0 | 1

[ :SENSe ] :TRHO:ACODE:APILot?

Key Path Meas Setup, More 1 of 3, Predefined Active Chan

Notes	This setting is valid with Active Code Chan is set to Combination or Predefined and the physical layer subtype is set to 2.
Preset	ON
State Saved	Saved in instrument state.
Range	On   Off
Example	TRHO:ACOD:APIL ON

### Data Channel Definition [Subtype 2 only]

**[ :SENSE ] :TRHO:ACODE:DATA:SUB2 B4 | Q4 | Q2 | Q4Q2 | E4E2 | OFF**  
**[ :SENSE ] :TRHO:ACODE:DATA:SUB2?**

Key Path	<b>Meas Setup, More 1 of 3, Predefined Active Chan</b>
Notes	This setting is valid with Active Code Chan is set to Combination or Predefined and the physical layer subtype is set to 2.
Preset	B4
State Saved	Saved in instrument state.
Range	B4   Q4   Q2   Q4Q2   E4E2   Off
Example	TRHO:ACOD:DATA:SUB2 B4

### Terminal Modulation Accuracy Measurement–ACK Channel Definition

**[ :SENSE ] :TRHO:ACODE:ACK OFF | ON | 0 | 1**  
**[ :SENSE ] :TRHO:ACODE:ACK?**

Set the reverse link ACK channel to active (On) or inactive (Off).

- On - Reverse link ACK is set to active.
- Off - Reverse link ACK is set to inactive.

Factory Preset: On

Remarks: You must be in the 1xEV-DO mode to use this command. Use INSTRUMENT:SElect to set the mode.

### Terminal Modulation Accuracy Measurement–ADC Range

**[ :SENSE ] :TRHO:ADC:RANGe**  
**AUTO | APEak | APLock | NONE | P0 | P6 | P12 | P18 | P24 | M6**

**[ :SENSe ] :TRHO:ADC:RANGe?**

Select a ranging function for the ADC gain control. This is an advanced control that normally does not need to be changed. If you are measuring a CW signal, see the following description.

- **AUTO** - This is automatic ranging. For FFT spectrums the auto ranging should not be used. An exception to this is if you know that your signal is “bursty,” then you can use auto to maximize the time domain dynamic range as long as your are not very interested in the FFT data.
- **APEak (Auto Peak)** - This is automatic ranging to the peak signal level. For CW signals the default of auto-peak ranging can be used. However, a better FFT measurement of the signal can be made by selecting one of the manual ranges available by specifying **NONE**, or **P0** through **P18**. Auto peaking can cause the ADC gain to monotonically track the ranges down during the data capture. This tracking effect should be negligible for the FFT spectrum, but selecting a manual range solves this possibility. If the CW signal being measured is close to the auto-ranging threshold, the noise floor may shift as much as 6 dB every sweep.
- **APLock (Auto Peak Lock)** - This is automatic ranging locked to the peak signal level. For CW signals, auto-peak lock ranging may be used. It will find the ADC gain most appropriate for this particular signal and will not track the ranges as auto peak can. If the CW signal being measured is close to the auto-ranging threshold, the noise floor may shift as much as 6 dB every sweep. For “bursty” signals, auto peak lock ranging should not be used. Since the ADC range can often be locked to the wrong one (resulting in overloading the ADC) the measurement will fail.
- **NONE** - This turns off any auto-ranging without making any changes to the current setting. This is not applicable for use with an Agilent VSA having a 12-bit ADC Board).
- **P0 through P18, P24, M6** - Manually selects one of the ADC ranges that add 0 dB (P0) to 18 dB (P18) and –6 dB (M6), 24 dB (P24) to the fixed gain across the range. Manual ranging is best for CW signals. M6 and P24 are applicable only for Agilent VSA analyzers having a 14-bit ADC board.

Factory Preset: **NONE** for Agilent PSA analyzers, including Agilent VSA analyzers with the 14-bit ADC board.

**M6** for Agilent VSA analyzers with the 12-bit ADC board.

Remarks: You must be in the 1xEV-DO mode to use this command. Use **INSTRument:SElect** to set the mode.



## Averaging State and Count

**[ :SENSE ] :TRHO:AVERAge:COUNT <integer>**

**[ :SENSE ] :TRHO:AVERAge:COUNT?**

**[ :SENSE ] :TRHO:AVERAge [ :STATe ] OFF | ON | 0 | 1**

**[ :SENSE ] :TRHO:AVERAge [ :STATe ] ?**

Set the number of data acquisitions that will be averaged. After the specified number of average counts, the averaging mode (terminal control) setting determines the averaging action.

Key Path:	<b>Meas Setup</b>
Preset:	10 , ON
State Saved:	Saved in instrument state.
Range:	1 to 10000 , On   Off
Step (Front Panel):	10
Example:	:TRHO:AVER:COUN 150 :TRHO:AVER OFF
Remote Command	Turn averaging on or off.
Notes:	

## Average Mode

**[ :SENSE ] :TRHO:AVERAge:TCONtrol EXPOnential | REPEAT**

**[ :SENSE ] :TRHO:AVERAge:TCONtrol?**

Select the type of termination control used for the averaging function. This determines the averaging action after the specified number of data acquisitions (average count) is reached.

KEY Exponential averaging	When Measure is set at Cont, data acquisitions will continue indefinitely. After N averages, exponential averaging is used with a weighting factor of N (the displayed average count stops at N). Exponential averaging weights new data more than old data, which allows tracking of slow-changing signals.
SCPI EXPOnential:	

KEY Repeat averaging  
SCPI REPeat: When Measure is set at Cont, data acquisitions will continue indefinitely. After N averages is reached, all previous result data is cleared and the average count is set back to 1. This is equivalent to being in Measure Single and pressing the Restart key when the Single measurement finishes.

Key Path: **Meas Setup**  
Preset: REPeat  
State Saved: Saved in instrument state.  
Range: Exp | Repeat  
Example: :TRHO:AVER:TCON EXP

### Average Slots

[ :SENSe ] :TRHO:AVERAge:SLOT HS1 | HS2 | FS

[ :SENSe ] :TRHO:AVERAge:SLOT?

Select the averaging slots within capture length. In Mod Accuracy measurement, Capture Length is 1 slot. The result in I/Q Measured Polar Graph view, I/Q Error view, and Code Domain Power view is a snapshot with selected slots by Meas Offset. If Meas Offset is set to 0, the user can see the result with first half slot in these view.

Key Path: **Meas Setup**  
Preset: HS1  
State Saved: Saved in instrument state.  
Range: 1st Half Slot | 2nd Half Slot | 1 slot over  
Example: :TRHO:AVER:SLOT FS

### Chip Rate

[ :SENSe ] :TRHO:CRATe <freq>

[ :SENSe ] :TRHO:CRATe?

Change the Chip Rate

Active Function Text:	Chip Rate
Key Path:	<b>Meas Setup, More 1 of 3, More 2 of 3, Advanced</b>
Unit/Terminator Keys:	Hz   kHz   MHz   GHz
Preset:	1.2288 MHz
State Saved:	Saved in instrument state.
Range:	1.10592 MHz to 1.35168 MHz
SCPI Resolution:	1.0 kHz
Step (Front Panel):	1.0 kHz
Example:	TRHO:CRAT 1.22 MHz

### Terminal Modulation Accuracy - Freq Error Tolerance Range

**[ :SENSe ] :TRHO:FERRor:TRANge WIDE | NORMAl | NARRow**

**[ :SENSe ] :TRHO:FERRor:TRANge?**

Frequency error tolerance range is specified: Normal, Wide or Narrow.

‘Wide’ provides a wider, or more loose, range of frequency error tolerance. To correctly demodulate signals of higher complexity, a more stringent frequency tolerance is required. For example, when composite channels are modulated on the same signal, the modulation is complex, and frequency error is critical to correct demodulation. When demodulating less demanding signals, set to ‘Normal’ or “Wide”.

Key Path:	<b>Meas Setup, More 1 of 3, More 2 of 3, Advanced, More 1 of 2</b>
Preset:	WIDE
State Saved:	Saved in instrument state.
Range:	WIDE   NORMAl
Example:	TRHO:MCES:TIM CHAN

### Terminal Modulation Accuracy - EVM Result I/Q Offset

**[ :SENSe ] :TRHO:IQOFFset:INCLude OFF | ON | 0 | 1**

**[ :SENSe ] :TRHO:IQOFFset:INCLude?**

Allows you to toggle the I/Q origin offset function between Std (standard) and Exclude.

**Std** : The measurement results for EVM, Rho, and Modulation Accuracy (Rho) error takes into account the I/Q origin offset.

**Exclude** : The measurement results for EVM, Rho, and Modulation Accuracy (Rho) error do not take into account the I/Q origin offset, and the message “EVM excludes I/Q Offset” is displayed in the lower right-hand graph display area.

Turn the automatic mode On or Off, for the I/Q origin offset function.

**Exclude: OFF** – The measurement results for EVM and Rho do not take into account the I/Q origin offset.

**Include: ON** – The measurement results for EVM and Rho take into account the I/Q origin offset.

Key Path:	Meas Setup, More 1 of 3, More 2 of 3, Advanced
Preset:	ON
State Saved:	Saved in instrument state.
Range:	Std   Exclude
Example:	TRHO:IQOF:INCL OFF

### Terminal Modulation Accuracy - Multi Channel Estimator

```
[ :SENSe ] :TRHO:MCEstimator OFF | ON | 0 | 1
```

```
[ :SENSe ] :TRHO:MCEstimator?
```

Allows you to toggle the multi channel estimator function between On and Off.

**On** : The individual code channels are aligned to the pilot channel to improve the phase error (whether each code phase is aligned or not). This takes a longer time.

**Off** : The phase information is computed from one coded signal only. (The phase of each code channel needs to be aligned to the pilot channel.)

Key Path:	Meas Setup, More 1 of 3, More 2 of 3, Advanced, More 1 of 2
Preset:	OFF
State Saved:	Saved in instrument state.
Range:	On   Off
Example:	TRHO:MCES ON

## Terminal Modulation Accuracy - Timing Estimation

**[ :SENSe ] :TRHO:MCEStimator:TIMing CHANnel | GLOBal**

**[ :SENSe ] :TRHO:MCEStimator:TIMing?**

Allows you to select timing estimation function between channel-by-channel and global.

Channel-by-Channel - The individual code channels are estimated as each timing. This takes a longer time.

Global : The individual code channels are estimated as global timing.

Key Path:	Meas Setup, More 1 of 3, More 2 of 3, Advanced, More 1 of 2
Preset:	GLOBal
State Saved:	Saved in instrument state.
Range:	CHANnel   GLOBal
Example:	TRHO:MCES:TIM CHAN

## Spectrum

**[ :SENSe ] :TRHO:SPECTrum NORMal | INVert**

**[ :SENSe ] :TRHO:SPECTrum?**

Set a spectrum either to Normal or Inverted for the demodulation related measurements. If set to INVert, the upper and lower spectrums are swapped.

Invert: This function conjugates the spectrum, which is equivalent to taking the negative of the quadrature component in demodulation. The correct setting (Normal or Invert) depends on whether the signal at the input of the instrument has a high or low side mix.

Key Path:	Meas Setup, More 1 of 2
Preset:	NORMal
State Saved:	Saved in instrument state.
Range:	Normal   Invert
Example:	TRHO:SPEC INV

## Terminal Modulation Accuracy - Sync Start Slot Detection State

**[ :SENSe ] :TRHO:SSLot:NUMBer <integer>**

**[ :SENSe ] :TRHO:SSLot:NUMBER?**

**[ :SENSe ] :TRHO:SSLot [ :STATe ] OFF | ON | 0 | 1**

**[ :SENSe ] :TRHO:SSLot [ :STATe ] ?**

For the measurement to begin at the first slot, the instrument must depend on trigger timing, or capture timing if the trigger is set to Free Run. If the user employs a trigger, the first slot number measured is determined by the trigger timing.

Alternatively, you can specify the synchronization starting slot number. For example, if the Sync start slot number is set to 5, the analysis starts from slot number 5.0. If Sync Start Slot detection mode is set to Off, the measurement is synchronized based on trigger timing or capture timing.

Key Path:	<b>Meas Setup, More 1 of 3</b>
Preset:	0 , OFF
State Saved:	Saved in instrument state.
Range:	0 to 16 , On   Off
Step (Front Panel):	1
Example:	:TRHO:FSL:NUMB 5 :TRHO:FSL ON
Remote Command	Turn first slot number detection mode on or off.
Notes:	

### **I Long Code Mask**

**[ :SENSe ] :TRHO:SYNC:ILCMask <long\_integer>**

**[ :SENSe ] :TRHO:SYNC:ILCMask?**

Set the Long Code Mask value for I axis.

Key Path:	<b>Meas Setup, More 1 of 2</b>
Preset:	0000000000
State Saved:	Saved in instrument state.
Range:	0000000000 to 4398046511103
SCPI Resolution:	1
Step (Front Panel):	1
Example:	TRHO:SYNC:ILCM 1

## Q Long Code Mask

**[ :SENSe ] :TRHO:SYNC:QLCMask <long\_integer>**

**[ :SENSe ] :TRHO:SYNC:QLCMask?**

Set the Long Code Mask value for Q axis.

Key Path:	Meas Setup, More 1 of 2
Preset:	00000000000
State Saved:	Saved in instrument state.
Range:	00000000000 to 4398046511103
SCPI Resolution:	1
Step (Front Panel):	1
Example:	TRHO:SYNC:QLCM 1

## Trigger Source

**[ :SENSe ] :TRHO:TRIGger:SOURCE**

**EXTERNAL [1] | EXTERNAL2 | IMMEDIATE | RFBURST | IF | FRAME**

**[ :SENSe ] :TRHO:TRIGger:SOURCE?**

Used to select the trigger source for the measurement.

KEY:Free Run (Immediate) SCPI:IMMEDIATE	The trigger occurs at the time the data is requested, completely asynchronous to the RF or IF signal. (also called free run)
KEY:Video SCPI:IF	An internal IF envelope trigger. It triggers on an absolute threshold level of the signal passed by the IF.
KEY:Ext Front SCPI:EXTERNAL[1]	Activates the external 1 trigger input. Location of the BNC Connector is Front panel.  The external trigger must be a signal between 5 and +5 volts.
KEY:Ext Rear SCPI:EXTERNAL2	Activates the external 2 trigger input. . Location of the BNC Connector is Front panel.  The external trigger must be a signal between 5 and +5 volts.

Programming Commands  
**SENSe Subsystem**

KEY:RF Burst SCPI:RFBurst	An internal wideband RF burst trigger that has an automatic level control for burst signals. It triggers on a level that is relative to the peak of the signal passed by the RF or absolute level.
KEY:Frame SCPI:FRAMe	Uses the internal periodic timer (used to called 'frame clock') to generate a trigger signal.

Key Path:	<b>Meas Setup</b>
Preset:	IMMEDIATE
State Saved:	Saved in instrument state.
Range:	Free Run (Immediate)   Video (IF Envp)   RF Burst   Ext Front   Ext Rear   Frame
Example:	TRHO:TRIG:SOUR EXT2



## Waveform (Time-Domain) Measurement

Commands for querying the waveform measurement results and for setting to the default values are found in the “[MEASure Group of Commands](#)” on page 375. The equivalent front panel keys for the parameters described in the following commands, are found under the **Meas Setup** key, after the **Waveform (Time Domain)** measurement has been selected from the **MEASURE** key menu.

### Waveform—Data Acquisition Packing

```
[ :SENSe ] :WAVEform:ACQuistion:PACKing AUTO | LONG | MEdium | SHORt
```

```
[ :SENSe ] :WAVEform:ACQuistion:PACKing?
```

This is an advanced control that normally does not need to be changed.

Factory Preset: AUTO

Remarks: To use this command for E4406A, the appropriate mode should be selected with INSTRument:SElect.

For PSA you must be in the Basic, cdmaOne, cdma2000, 1xEV-DO, W-CDMA, GSM, EDGE, NADC, or PDC mode to use this command. Use INSTRument:SElect to set the mode.

### Waveform—ADC Dither State

```
[ :SENSe ] :WAVEform:ADC:DITHer [ :STATe ] OFF | ON | 0 | 1
```

```
[ :SENSe ] :WAVEform:ADC:DITHer [ :STATe ] ?
```

This is an Advanced control that normally does not need to be changed.

Factory Preset: OFF

Remarks: To use this command for E4406A, the appropriate mode should be selected with INSTRument:SElect.

For PSA you must be in the Basic, cdmaOne, cdma2000, 1xEV-DO, W-CDMA, GSM, EDGE, NADC, or PDC mode to use this command. Use INSTRument:SElect to set the mode.

### Waveform—Pre-ADC Bandpass Filter

```
[ :SENSe ] :WAVEform:ADC:FILTer [ :STATe ] OFF | ON | 0 | 1
```

```
[ :SENSe ] :WAVEform:ADC:FILTer [ :STATe ] ?
```

Turn the pre-ADC bandpass filter on or off. This is an Advanced control that normally does not need to be changed.

Preset: OFF

Remarks: To use this command for E4406A, the appropriate mode should be selected with INSTRUMENT:SElect.

For PSA you must be in the Basic, cdmaOne, cdma2000, 1xEV-DO, W-CDMA, GSM, EDGE, NADC, or PDC mode to use this command. Use INSTRUMENT:SElect to set the mode.

### Waveform—ADC Range

E4406A

```
[ :SENSe ] :WAVEform:ADC:RANGe AUTO | APEak | APLock | GROund | M6  
| P0 | P6 | P12 | P18 | P24
```

PSA

```
[ :SENSe ] :WAVEform:ADC:RANGe AUTO | APEak | APLock | GROund | NONE  
| P0 | P6 | P12 | P18
```

```
[ :SENSe ] :WAVEform:ADC:RANGe?
```

Select the range for the gain-ranging that is done in front of the ADC. This is an Advanced control that normally does not need to be changed.

AUTO - automatic range

Auto Peak (APEak) - automatically peak the range

Auto Peak Lock (APLock)- automatically peak lock the range

GROund - ground

NONE - (PSA) turn off auto-ranging without making any changes to the current setting.

M6 - (E4406A) subtracts 6 dB of fixed gain across the range

P0 to P18 - (PSA) adds 0 to 18 dB of fixed gain across the range

P0 to P24 - (E4406A) adds 0 to 24 dB of fixed gain across the range

Factory Preset: AUTO

Remarks: To use this command for E4406A, the appropriate mode should be selected with INSTRUMENT:SElect.

For PSA you must be in the Basic, cdmaOne, cdma2000, 1xEV-DO, W-CDMA, GSM, EDGE, NADC, or PDC mode to use this command. Use INSTRUMENT:SElect to set the mode.

## Waveform - Query Aperture Setting

**[ :SENSe ] :WAVeform:APERTure?**

Returns the waveform sample period (aperture) based on current resolution bandwidth, filter type, and decimation factor. Sample rate is the reciprocal of period.

Remarks: To use this command for E4406A, the appropriate mode should be selected with INSTRUMENT:SELEct.

For PSA you must be in the Basic, cdmaOne, cdma2000, 1xEV-DO, W-CDMA, GSM, EDGE, NADC, or PDC mode to use this command. Use INSTRUMENT:SELEct to set the mode.

## Waveform—Number of Averages

**[ :SENSe ] :WAVeform:AVERAge:COUNT <integer>**

**[ :SENSe ] :WAVeform:AVERAge:COUNT?**

Set the number of sweeps that will be averaged. After the specified number of sweeps (average counts), the averaging mode (terminal control) setting determines the averaging action.

Factory Preset: 10

Range: 1 to 10,000

Remarks: To use this command for E4406A, the appropriate mode should be selected with INSTRUMENT:SELEct.

For PSA you must be in the Basic, cdmaOne, cdma2000, 1xEV-DO, W-CDMA, GSM, EDGE, NADC, or PDC mode to use this command. Use INSTRUMENT:SELEct to set the mode.

## Waveform—Averaging State

**[ :SENSe ] :WAVeform:AVERAge [ :STATe ] OFF | ON | 0 | 1**

**[ :SENSe ] :WAVeform:AVERAge [ :STATe ] ?**

Turn averaging on or off.

Factory Preset: OFF

Remarks: To use this command for E4406A, the appropriate mode should be selected with INSTRUMENT:SELEct.

For PSA you must be in the Basic, cdmaOne, cdma2000, 1xEV-DO, W-CDMA, GSM, EDGE, NADC, or PDC mode to use this command. Use INSTRUMENT:SELEct to

set the mode.

### Waveform—Averaging Mode

**[ :SENSe ] :WAVeform:AVERAge:TCONtrol EXPonential | REPeat**

**[ :SENSe ] :WAVeform:AVERAge:TCONtrol?**

Select the type of termination control used for the averaging function. This determines the averaging action after the specified number of ‘sweeps’ (average count) is reached.

EXPonential - Each successive data acquisition after the average count is reached, is exponentially weighted and combined with the existing average.

REPeat - After reaching the average count, the averaging is reset and a new average is started.

Factory Preset: EXPonential

Remarks: To use this command for E4406A, the appropriate mode should be selected with INSTRument:SElect.

For PSA you must be in the Basic, cdmaOne, cdma2000, 1xEV-DO, W-CDMA, GSM, EDGE, NADC, or PDC mode to use this command. Use INSTRument:SElect to set the mode.

### Waveform—Averaging Type

**[ :SENSe ] :WAVeform:AVERAge:TYPE**

**LOG | MAXimum | MINimum | RMS | SCALar**

**[ :SENSe ] :WAVeform:AVERAge:TYPE?**

Select the type of averaging.

LOG - The log of the power is averaged. (This is also known as video averaging.)

MAXimum - The maximum values are retained.

MINimum - The minimum values are retained.

RMS - The power is averaged, providing the rms of the voltage.

Factory Preset: RMS

Remarks: To use this command for E4406A, the appropriate mode should be selected with INSTRument:SElect.

For PSA you must be in the Basic, cdmaOne, cdma2000, 1xEV-DO, W-CDMA, GSM, EDGE, NADC, or PDC

mode to use this command. Use INSTRUMENT:SElect to set the mode.

### Waveform—Resolution BW

**[ :SENSe ] :WAVEform: BANDwidth | BWIDth [ :RESolution ] <freq>**

**[ :SENSe ] :WAVEform: BANDwidth | BWIDth [ :RESolution ] ?**

Set the resolution bandwidth. This value is ignored if the function is auto-coupled.

Factory Preset: 100.0 kHz for NADC, PDC, cdma2000, W-CDMA, Basic, Service (E4406A)  
500.0 kHz for GSM  
2.0 MHz for cdmaOne

Range: 1.0 kHz to 8.0 MHz when  
[:SENSe]:WAVEform: BANDwidth | BWIDth  
[:RESolution]:TYPE GAUSSian

1.0 kHz to 10.0 MHz when  
[:SENSe]:WAVEform: BANDwidth | BWIDth  
[:RESolution]:TYPE FLATtop

Remarks: To use this command for E4406A, the appropriate mode should be selected with INSTRUMENT:SElect.

For PSA you must be in the Basic, cdmaOne, cdma2000, 1xEV-DO, W-CDMA, GSM, EDGE, NADC, or PDC mode to use this command. Use INSTRUMENT:SElect to set the mode.

Bandwidths > 6.7 MHz will require a slight increase in measurement time.

### Waveform - Query Actual Resolution Bandwidth

**[ :SENSe ] :WAVEform: BANDwidth: RESolution ] :ACTual?**

Due to memory constraints the actual resolution bandwidth value may vary from the value entered by the user. For most applications the resulting difference in value is inconsequential but for some it is necessary to know the actual value; this query retrieves the actual resolution bandwidth value.

Remarks: To use this command for E4406A, the appropriate mode should be selected with INSTRUMENT:SElect.

For PSA you must be in the Basic, cdmaOne, cdma2000, 1xEV-DO, W-CDMA, GSM, EDGE, NADC, or PDC mode to use this command. Use INSTRUMENT:SElect to

set the mode.

History: E4406A:  
Version A.05.00 or later

### Waveform—Resolution BW Filter Type

**[ :SENSe ] :WAVeform: BANDwidth | BWIDth [ :RESolution ] :TYPE  
FLATtop | GAUSSian**

**[ :SENSe ] :WAVeform: BANDwidth | BWIDth [ :RESolution ] :TYPE?**

Select the type of Resolution BW filter that is used. This is an Advanced control that normally does not need to be changed.

FLATtop - a filter with a flat amplitude response, which provides the best amplitude accuracy.

GAUSSian - a filter with Gaussian characteristics, which provides the best pulse response.

Factory Preset: GAUSSian

Remarks: To use this command for E4406A, the appropriate mode should be selected with INSTRument:SElect.

For PSA you must be in the Basic, cdmaOne, cdma2000, 1xEV-DO, W-CDMA, GSM, EDGE, NADC, or PDC mode to use this command. Use INSTRument:SElect to set the mode.

### Waveform—Decimation of Waveform Display

**[ :SENSe ] :WAVeform: DECimate [ :FACTor ] <integer>**

**[ :SENSe ] :WAVeform: DECimate [ :FACTor ] ?**

Set the amount of data decimation done on the IQ data stream. For example, if 4 is selected, three out of every four data points will be thrown away. So every 4th data point will be kept.

Factory Preset: 1

Range: 1 to 4

Remarks: To use this command for E4406A, the appropriate mode should be selected with INSTRument:SElect.

For PSA you must be in the Basic, cdmaOne, cdma2000, 1xEV-DO, W-CDMA, GSM, EDGE, NADC, or PDC mode to use this command. Use INSTRument:SElect to set the mode.

### Waveform—Control Decimation of Waveform Display

**[ :SENSe ] :WAVEform:DECimate:STATE OFF | ON | 0 | 1**

**[ :SENSe ] :WAVEform:DECimate:STATE?**

Set the amount of data decimation done by the hardware in order to decrease the number of acquired points in a long capture time. This is the amount of data that the measurement ignores.

Factory Preset: OFF

Remarks: To use this command for E4406A, the appropriate mode should be selected with INSTRUMENT:SElect.

For PSA you must be in the Basic, cdmaOne, cdma2000, 1xEV-DO, W-CDMA, GSM, EDGE, NADC, or PDC mode to use this command. Use INSTRUMENT:SElect to set the mode.

### Waveform—Sweep (Acquisition) Time

**[ :SENSe ] :WAVEform:SWEep:TIME <time>**

**[ :SENSe ] :WAVEform:SWEep:TIME?**

Set the measurement acquisition time. It is used to specify the length of the time capture record.

Factory Preset: 2.0 ms

10.0 ms, for NADC, PDC

15.0 ms, for iDEN mode (E4406A)

Range: 1  $\mu$ s to 100 s

Default Unit: seconds

Remarks: To use this command for E4406A, the appropriate mode should be selected with INSTRUMENT:SElect.

For PSA you must be in the Basic, cdmaOne, cdma2000, 1xEV-DO, W-CDMA, GSM, EDGE, NADC, or PDC mode to use this command. Use INSTRUMENT:SElect to set the mode.

### Waveform—Trigger Source

**[ :SENSe ] :WAVEform:TRIGger:SOURce EXTernal [1] | EXTernal2 | FRAME | IF | IMMEDIATE | LINE | RFBurst**

**[ :SENSe ] :WAVEform:TRIGger:SOURce?**

Select the trigger source used to control the data acquisitions.

EXTernal 1 - front panel external trigger input

EXTernal 2 - rear panel external trigger input

FRAMe - internal frame timer from front panel input

IF - internal IF envelope (video) trigger

IMMEDIATE - the next data acquisition is immediately taken (also called free run)

LINE - internal line trigger

RFBurst - wideband RF burst envelope trigger that has automatic level control for periodic burst signals

Factory Preset: IMMEDIATE (free run), for Basic, cdmaOne, NADC, PDC mode

RFBurst, for GSM, iDEN (E4406A) modes

Remarks: To use this command for E4406A, the appropriate mode should be selected with INSTRUMENT:SElect.

For PSA you must be in the Basic, cdmaOne, cdma2000, 1xEV-DO, W-CDMA, GSM, EDGE, NADC, or PDC mode to use this command. Use INSTRUMENT:SElect to set the mode.



## TRIGger Subsystem

The Trigger Subsystem is used to set the controls and parameters associated with triggering the data acquisitions. Other trigger-related commands are found in the INITiate and ABORT subsystems.

The trigger parameters are global within a selected Mode. The commands in the TRIGger subsystem set up the way the triggers function, but selection of the trigger source is made from each measurement. There is a separate trigger source command in the SENSE:<meas> subsystem for each measurement. The equivalent front panel keys for the parameters described in the following commands, can be found under the **Mode Setup, Trigger** key.

### Automatic Trigger Control

**:TRIGger[:SEQuence]:AUTO:STATe OFF|ON|0|1**

**:TRIGger[:SEQuence]:AUTO:STATe?**

Turns the automatic trigger function on and off. This function causes a trigger to occur if the designated time has elapsed and no trigger occurred. It can be used with unpredictable trigger sources, like external or burst, to make sure a measurement is initiated even if a trigger doesn't occur. Use TRIGger[:SEQuence]:AUTO[:TIME] to set the time limit.

Factory Preset

and \*RST Off for cdma2000, W-CDMA, NADC, PDC, 1xEV-DO

Front Panel

Access **Mode Setup, Trigger, Auto Trig**

### Automatic Trigger Time

**:TRIGger[:SEQuence]:AUTO[:TIME] <time>**

**:TRIGger[:SEQuence]:AUTO[:TIME]?**

After the measurement is activated the instrument will take a data acquisition immediately upon receiving a signal from the selected trigger source. If no trigger signal is received by the end of the time specified in this command, a data acquisition is taken anyway. TRIGger[:SEQuence]:AUTO:STATE must be on.

Factory Preset: 100.0 ms

Range: 1.0 ms to 1000.0 s

0.0 to 1000.0 s for cdma2000, W-CDMA, 1xEV-DO

Default Unit: seconds

Front Panel

Access **Mode Setup, Trigger, Auto Trig**

## External Trigger Delay

**:TRIGger[:SEquence]:EXTernal[1]|2:DELay <time>**

**:TRIGger[:SEquence]:EXTernal[1]|2:DELay?**

Set the trigger delay when using an external trigger. Set the trigger value to zero (0) seconds to turn off the delay.

EXT or EXT1 is the front panel trigger input.

EXT2 is the rear panel trigger input.

Factory Preset: 0.0 s

Range: -100.0 ms to 500.0 ms

Default Unit: seconds

Front Panel

Access: **Mode Setup, Trigger, Ext Rear (or Ext Front), Delay**

## External Trigger Level

**:TRIGger[:SEquence]:EXTernal[1]|2:LEVel <voltage>**

**:TRIGger[:SEquence]:EXTernal[1]|2:LEVel?**

Set the trigger level when using an external trigger input.

EXT or EXT1 is the front panel trigger input

EXT2 is the rear panel trigger input

Factory Preset: 2.0 V

Range: -5.0 to +5.0 V

Default Unit: volts

Front Panel

Access: **Mode Setup, Trigger, Ext Rear (or Ext Front), Level**

## External Trigger Slope

**:TRIGger[:SEquence]:EXTernal[1]|2:SLOPe NEGative|POSitive**

**:TRIGger[:SEquence]:EXTernal[1]|2:SLOPe?**

Sets the trigger slope of an external trigger input to either NEGative or POSitive.

EXT or EXT1 is the front panel trigger input.

EXT2 is the rear panel trigger input.

Factory Preset: Positive

Front Panel

Access: **Mode Setup, Trigger, Ext Rear (or Ext Front), Slope**

## Frame Trigger Adjust

**:TRIGger[:SEquence]:FRAMe:ADJust <time>**

Lets you advance the phase of the frame trigger by the specified amount. It does not change the period of the trigger waveform. If the command is sent multiple times, it advances the phase of the frame trigger more each time it is sent.

Factory Preset: 0.0 s

Range: 0.0 to 10.0 s

Default Unit: seconds

Front Panel

Access: None

## Frame Trigger Period

**:TRIGger[:SEquence]:FRAMe:PERiod <time>**

**:TRIGger[:SEquence]:FRAMe:PERiod?**

Set the frame period that you want when using the external frame timer trigger. If the traffic rate is changed, the value of the frame period is initialized to the preset value.

Factory Preset: 250.0  $\mu$ s for Basic, cdmaOne

4.615383 ms, for GSM

26.666667 ms for cdma2000 and 1xEV-DO

10.0 ms (1 radio frame) for W-CDMA

90.0 ms for iDEN (E4406A)

20.0 ms with rate=full for NADC, PDC

40.0 ms with rate=half for NADC, PDC

Range: 0.0 ms to 559.0 ms for Basic, cdmaOne, GSM,

cdma2000, W-CDMA, 1xEV-DO

1.0 ms to 559.0 ms for iDEN (E4406A), NADC, PDC

Default Unit: seconds

Front Panel

Access: **Mode Setup, Trigger, Frame Timer, Period**

## Frame Trigger Sync Source

**:TRIGger [:SEquence] :FRAME:SYNC EXTFront | EXTRear | OFF**

**:TRIGger [:SEquence] :FRAME:SYNC?**

Selects the input port location for the external frame trigger that you are using.

Factory Preset: Off

Remarks: You must be in the Basic, cdmaOne, EDGE (w/GSM), GSM, iDEN (E4406A), NADC, PDC, Service mode to use this command. Use INSTRUMENT:SElect to set the mode.

Front Panel

Access: **Mode Setup, Trigger, Frame Timer, Sync Source**

History Changed firmware revision A.05.00.

## Frame Trigger Synchronization Offset

**:TRIGger [:SEquence] :FRAME:SYNC:OFFSet <time>**

**:TRIGger [:SEquence] :FRAME:SYNC:OFFSet?**

Lets you adjust the frame triggering with respect to the external trigger input that you are using.

Factory Preset: 0.0 s

Range: 0.0 to 10.0 s

Default Unit: seconds

Remarks: You must be in the Basic, cdmaOne, GSM, EDGE, iDEN (E4406A), NADC, PDC, Service mode to use this command. Use INSTRUMENT:SElect to set the mode.

History: Revision A.03.27 or later

Front Panel

Access: **Mode Setup, Trigger, Frame Timer, Offset**

## Trigger Holdoff

**:TRIGger[:SEquence]:HOLDoff <time>**

**:TRIGger[:SEquence]:HOLDoff?**

Set a value of the holdoff time between triggers. After a trigger, another trigger will not be allowed until the holdoff time expires. This parameter affects all trigger sources.

Factory Preset: 0.0 s

20.0 ms for iDEN (E4406A)

10.0 ms for NADC or PDC

Range: 0.0 to 500.0 ms

Default Unit: seconds

Front Panel

Access: **Mode Setup, Trigger, Trigger Holdoff**

## Video (IF) Trigger Delay

**:TRIGger[:SEquence]:IF:DELay <time>**

**:TRIGger[:SEquence]:IF:DELay?**

Set a value of the trigger delay of the IF (video) trigger (signal after the resolution BW filter).

Factory Preset: 0.0 s

Range: -100.0 ms to 500.0 ms

Default Unit: seconds

Front Panel

Access: **Mode Setup, Trigger, Video (IF Envlp), Delay**

## Video (IF) Trigger Level

**:TRIGger[:SEquence]:IF:LEVel <ampl>**

**:TRIGger[:SEquence]:IF:LEVel?**

Set the trigger level when using the IF (video) trigger.

Factory Preset: -6.0 dBm for cdmaOne, GSM, EDGE, Basic, Service (E4406A), cdma2000, W-CDMA, 1xEV-DO

–20.0 dBm for iDEN (E4406A)  
–30.0 dBm for NADC, PDC  
Range: –200.0 to 50.0 dBm  
Default Unit: dBm  
Front Panel  
Access: **Mode Setup, Trigger, Video (IF Envlp), Level**

## Video (IF) Trigger Slope

```
:TRIGger[:SEquence]:IF:SLOPe NEGative|POSitive  
:TRIGger[:SEquence]:IF:SLOPe?
```

Sets the trigger slope when using the IF (video) trigger, to either NEGative or POSitive.

Factory Preset: Positive

Front Panel  
Access: **Mode Setup, Trigger, Video (IF Envlp), Slope**

## RF Burst Trigger Delay

```
:TRIGger[:SEquence]:RFBurst:DELAy <time>  
:TRIGger[:SEquence]:RFBurst:DELAy?
```

Set the trigger delay when using the RF burst (wideband) trigger.

Factory Preset: 0.0  $\mu$ s

Range: –100.0 ms to 500.0 ms

Default Unit: seconds

Front Panel  
Access: **Mode Setup, Trigger, RF Burst, Delay**

## RF Burst Trigger Level

```
:TRIGger[:SEquence]:RFBurst:LEVel <rel_power>  
:TRIGger[:SEquence]:RFBurst:LEVel?
```

Set the trigger level when using the RF Burst (wideband) Trigger. The value is relative to the peak of the signal. RF Burst is also known as RF Envelope.

Factory Preset: -6.0 dB  
Range: -25.0 to 0.0 dB  
-200.0 to 0.0 dB for NADC, PDC  
Default Unit: dB  
Front Panel  
Access: **Mode Setup, Trigger, RF Burst, Peak Level**

## RF Burst Trigger Slope

**:TRIGger[:SEquence]:RFBurst:SLOPe NEGative|POSitive**

**:TRIGger[:SEquence]:RFBurst:SLOPe?**

Set the trigger slope when using the RF Burst (wideband) Trigger.

Factory Preset: Positive

Remarks: You must be in the cdmaOne, cdma2000, W-CDMA mode to use this command. Use :INSTRument:SElect to set the mode.

Front Panel  
Access: **Mode Setup, Trigger, RF Burst, Slope**





---

## 5 Concepts

This chapter provides details about the 1xEV-DO communications system, and explains how the various measurements are performed by the instrument. Suggestions for optimizing and troubleshooting your setup are provided, along with a list of related Agilent documents that are referenced for further information.

---

## What Is the 1xEV-DO System?

1xEV-DO is the name applied to the first single-channel evolution (1xEV) of a 3GPP2 communications system optimized for data only (-DO). As 1xEV-DO has evolved from the cdma2000 voice system and has structural similarity to cdma2000, this discussion will also describe the differences between 1xEV-DO and cdma2000.

### RF Characteristics

1xEV-DO uses what is known as High Rate Packet Data, using the same final spread rate of 1.2288 Mcps as does cdma2000 SR1. It also uses the same digital filter to reduce the final modulation bandwidth, with the result that 1xEV-DO is spectrally compatible with cdma2000 SR1. Both 1xEV-DO and cdma2000 SR1 can utilize the same amplifiers, combiners, and antennas to reduce the installation cost of 1xEV-DO.

Although 1xEV-DO is compatible with much existing cdma2000 infrastructure, the two systems may not simultaneously occupy the same channel. Each 1xEV-DO channel requires a paired 1.25 MHz clear channel, therefore it can not be overlaid with cdma2000 channels.

### Access Terminal & Access Network

There is an inclusion of the new terminology in 1xEV-DO as follows:

- Access Terminal (AT) - A device equipped with a radio modem and a data interface which allows the user to access a packet data network through the 1xEV-DO access network.
- Access Network (AN) - A network equipment that provides data connectivity between a packet-switched data network such as Internet and the ATs.

### Forward Link

1xEV-DO relies on the Global Positioning System (GPS) for intercell synchronization, in the same manner as cdma2000. The 1xEV-DO system is well suited for data transmission in the forward link, as it is optimized for high speed packet data communications from ANs (base stations) to ATs (mobile stations). Average delivery rates of about 600 kHz per sector on a continuous basis have been demonstrated. When compared to the recent IS-95-B design in cdma2000, 1xEV-DO shows about a 6 times improvement in the overall network data rate.

The largest contribution to overall increased data throughput is the ability of 1xEV to negotiate for increased data rates for individual users or mobiles, as only one user is served at a time. This and other

contributing factors are described in detail in the Design Elements section below.

### Frame Structure

The frame structure is different from that used for cdma2000 and IS-95 systems, as they are based on 20 ms frames set by the codec for speech. The frame period for 1xEV-DO is 26.667 ms, which is also the period of one pilot channel. Each frame is divided up into 16 slots of 1.667 ms.

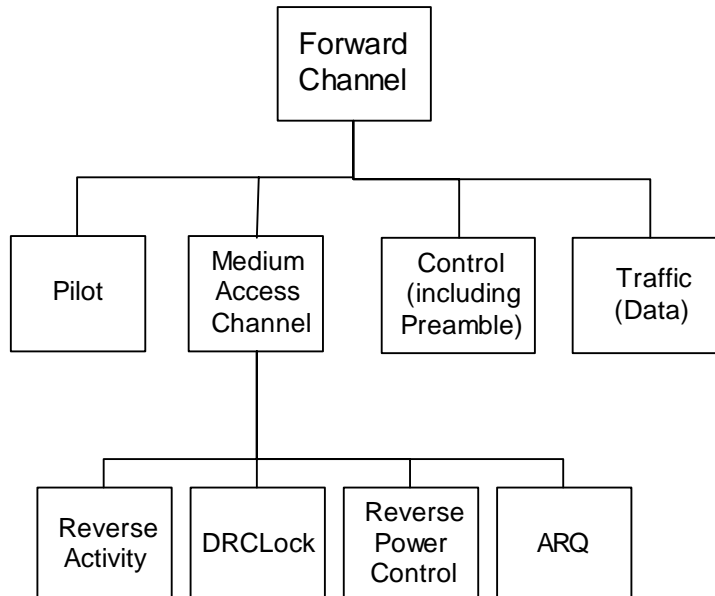
### Design Elements

When compared to a voice communication system of cdma2000, the following design elements of the forward link contribute to raise the data rate:

- Full power - The cell is always at full power, resulting in no overhead needed for statistical variations of multiple users.
- Best serving cell - When in soft handoff, the mobile selects the best serving cell and can only request and receive data from that cell.
- Efficient data delivery - The base station can send data to a mobile at times when its rate request is higher than the running average of the base station, and will avoid sending data when the requested rate is lower than the running average.

The forward link is always transmitted at its full power, using a rate control scheme instead of a power control scheme, as in cdma2000. The data is TDM (time division multiplexed) to the various users or mobiles, with only one being served at any time. Each mobile measures signal-to-noise ratio (S/N) on the forward link pilot every slot, 1.667 ms, and sends a data rate request to the base station every 1.667 ms. The base station decides which mobile should be served next. The maximum data transfer from the network will be achieved if only the most favorable links get served, however, this is accomplished at the expense of the distant users.

## Forward Channel Structure



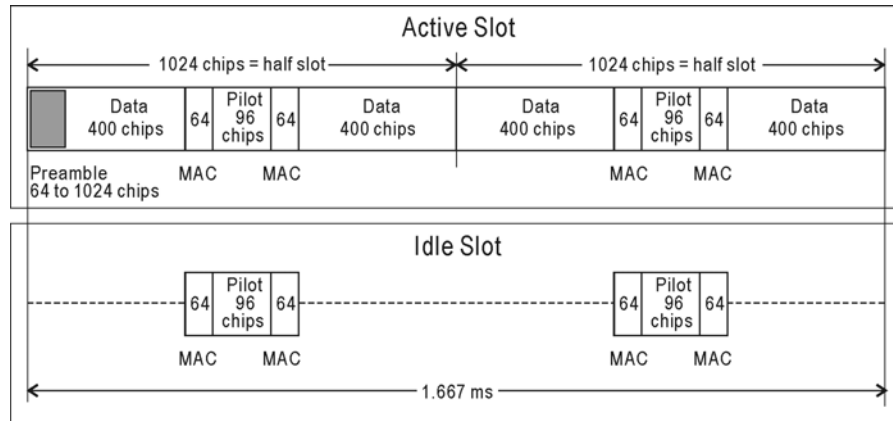
The following four different channels are used and are Time Division Multiplexed (TDM):

- **Traffic Channel** - The data following the turbo coder is scrambled by mixing with a PN sequence, the initial state of which is based on known parameters, and is unique for each user. At the same initial value of the PN sequence, every packet starts. QPSK modulation is used for data rate up to 1.2288 Mbps. Higher order modulation, with either 8PSK with 3 bits per symbol or 16QAM with 4 bits per symbol, is used for higher data rates. The levels of the I and Q symbols are mathematically chosen so that the average power becomes 1. The I and Q channels are mapped into 16 parallel Walsh covers, each of length 16. The I and Q outputs with the Walsh covers signals are added.
- **Preamble** - At the beginning of the transmission to one user, there is a preamble that is embedded in the data. This preamble contains the user ID for the data, and its repeat rate is determined by the data rate; lower data rates require higher repeat values. At its largest, the preamble will fill more than a half the first slot.
- **Medium Access Control (MAC)** - This layer consists of the reverse power control (RPC) and the reverse activity (RA). The power control bits are sent in parallel to all mobiles with an open connection. Each one is assigned a different 64-bit Walsh code which gets transmitted on either the I or Q channel. The codes 0 through 3 are reserved. The Walsh code 4 is the RA cover. The Walsh codes 5 through 63 are allocated to RPC. One Walsh code is allocated for power control to each active reverse link. Power control bits for all of the reverse links

are sent in parallel as part of the MAC channel. These are made of 4 repetitions of an assigned Walsh code of length 64. The RA channel is used to indicate that the sector is busy decoding multiple reverse link signals.

- Pilot - The pilot signal is gated on for only 192 chips per slot. The differentiator between the cell and the sector is still the PN offset of the pilot channel.

The data structure per slot can be illustrated as follows:



## Reverse Link Coding

The reverse link for 1xEV-DO has a structure similar to that for cdma2000, except that in addition to a data channel, the following channels are also included:

- Reverse Rate Indication (RRI) - This replaces with the power control bits to indicate of which data rate is requested by the mobile.
- Data Request Channel (DRC) - This contains a 4 bit word in each slot to allow the choice of up to 16 different transmission rates. Different Walsh covers are used to indicate which PN offset in the active set is preferred for transmission.
- Ack Channel - This acknowledgement channel is only transmitted after the mobile detects a frame with its preamble, meaning the packet is directed to that mobile. The 1 bit on this channel, which is transmitted for a half slot, is used to indicate a successful reception or an erasure.

The Pilot in 1xEV-DO is still punctured but the information carried is different:

In cdma2000, the Pilot is punctured in a 3:1 ratio (3 Pilot, 1 Data) to carry power control bits. The puncture period is 1 Power Control Group, or 1.25 ms. The data rate for PCB is 16 bits per 20 ms frame.

**What Is the 1xEV-DO System?**

In 1xEV-DO, the puncture pattern is 7:1 on each slot (7 Pilot, 1 Data). The underlying data is coded, and the transmission rate is 3 bits per 26.667 ms frame.

In 1xEV all signaling is performed on the data channel so there is no Dedicated Control Channel. The data channel can support 5 data rates which are separated in powers of 2 (256 through 4096 bits, or 9.6 through 153.6 kbps). These rates are achieved by varying the repeat factor. The highest rate uses a Turbo coder with lower gain.

**Reverse Link Scrambling**

The Pilot, ACK, DRC, and Data channels are added with each other in a manner that maps some into I and some into Q for eventual spreading. The final spreading is made similarly to cdma2000 with HPSK. In 1xEV-DO, the long code used for spreading is seeded with a fixed pattern at the start of every Pilot sequence, every 26.667 ms. There are separate masks, 42 bits long, for the I and Q long spreading codes. In cdma2000, the long code generator is based on system time, or in other words a continuous clock.

## Standard Documents

1xEV-DO is defined in the following Telecommunications Industry Association (TIA) and Electronics Industry Alliance (EIA) document:

3GPP2 C.S0024 Version 2.01 cdma2000 High Rate Packet Data Air Interface Specification

3GPP2 C.S0032 Recommended Minimum Performance Standards for cdma2000 High Rate Packet Data Access Network

3GPP2 C.S0033 Recommended Minimum Performance Standards for cdma2000 High Rate Packet Data Access Terminal

TIA/EIA/IS-856 cdma2000 High Rate Packet Data Air Interface Specification

## Compatibility with IS-2000

When interpreting TIA/EIA/IS-2000 in the context of TIA/EIA/IS-856, the terms for TIA/EIA/IS-2000 should be mapped as follows:

<b>TIA/EIA/IS-2000</b>	<b>TIA/EIA/IS-856</b>
BS	AN
Base Station	Access Network
BSC	AN
Base Station Control	Access Network
Call	Connection
MS	AT
Mobile Station	Access Terminal

---

## Channel Power Measurement Concepts

### Purpose

The Channel Power measurement is a common test used in the wireless industry to measure the total transmitted power of a radio within a defined frequency channel. This procedure measures the total power within the defined channel for 1xEV-DO. This measurement is applied to design, characterize, evaluate, and verify transmitters and their components or devices for base stations and mobile stations.

---

#### NOTE

For 1xEV-DO, depending on the installed measurement personality revision and measurement selection, the test device is fixed to base stations.

---

### Measurement Method

The Channel Power measurement reports the total transmitted power within the channel bandwidth, 1.23000 MHz for the 1xEV-DO mode. The measurement acquires a number of points representing the input signal in the time domain. It transforms this information into the frequency domain using FFT and then calculates the channel power. The effective resolution bandwidth of the frequency domain trace is proportional to the number of points acquired for FFT. The fastest FFT process is achieved using a number of acquired points that is a power of 2 (for example: 64, 128, 512).

Since the measurement is optimized for speed and accuracy, you are permitted to change only the number of acquired data points in powers of 2, not the actual resolution bandwidth which is shown in gray. However, if absolute sweep time is required, it can be changed to the user's specific value at the expense of reduced speed. At no time will both sweep time and data points be set to manual because of conflicting parameter settings. This flexibility is available through the **Advanced** menu of the channel power measurement.

To improve repeatability, you can increase either the number of averages or the number of data points with longer time record length. The channel power graph is shown in the graph window, while the absolute channel power in dBm and the mean power spectral density in dBm/Hz are shown in the text window.



## Code Domain Measurement Concepts

### Purpose

Since the code domain measurements despread and descramble the 1xEV-DO signal into its physical channels, the number of active channels of various symbol rates (which are denoted by widths) can be observed. The width of the channel is inversely proportional to the Walsh code length in number of bits. In the code domain, there is a fixed amount of code space for a given chip rate. Therefore, by using the different Walsh codes, the system can dynamically allocate the code spaces for high speed data users.

This code domain power composite view provides information about the in-channel characteristics of the 1xEV-DO signal. It directly informs the user of the active channels with their individual channel powers. The composite view also shows which data rates are active and the corresponding amount of code space used. The following are conditions under which a general unlock can occur: the Pilot signal is too low in power or no Pilot signal available, the frequency error is too large, or a frequency inversion is present.

When the level of the code domain noise floor is too high, relative to a reference or an expected level, one of the possible causes might be due to CW interference, like local oscillator feedthrough or spurs. I/Q modulation impairments can be another source of this uncorrelated noise. The I/Q demodulation measurements can reveal errors such as I/Q gain imbalance or I/Q quadrature error

### Measurement Method

This procedure measures the power levels of the spread channels in composite RF channels. The **Measure** default in the **Meas Control** menu is **Single** for this measurement.

The code domain measurement displays the power for each of the spread channels, relative to the total power within the 1.230 MHz channel bandwidth centered at the center frequency. Each spread channel level is displayed as an individual vertical bar with a different width determined by a spread rate. Because this is a relative measurement, the unit of measure is dB (not dBm or watts). This allows a comparison of signal levels between the Pilot, MAC, and Traffic channels.

The following displays are available for this measurement:

- Power Graph & Metrics - The transmitted energy associated with each of the symbol rates and Walsh codes is shown in the graph window. The following channel powers along with the total absolute

power and the total active channel power are shown in the text window for BTS tests:

		<b>I/Q Combined Power Bar</b>	
<b>Chan Type</b>	<b>Off</b>	<b>On</b>	
<b>Pilot or MAC</b>	I Avg Active Ch: I Max Inactive Ch: Q Avg Active Ch: Q Max Inactive Ch: Active Channels:	Max Active Ch: Avg Active Ch: Max Inactive Ch: Avg Inactive Ch: Active Channels:	
<b>Data</b>	I Max Active Ch: I Min Active Ch: Q Max Active Ch: Q Min Active Ch: Active Channels: Preamble Length: Preamble MAC Index:	Max Active Ch: Min Active Ch:  Active Channels: Preamble Length: Preamble MAC Index:	

- I/Q Polar & Power Graph - The graphs of the code domain power, the symbol I/Q polar, and the chip power versus time are shown in the graph windows.

## Intermodulation Measurement Concepts

### Purpose

The 1xEV-DO standard defines transmit intermodulation as a measure of transmitter quality. Intermodulation products are generated by non-linear components or devices in equipment where two signals, one desired and another undesired, are present. Transmit intermodulation is a measure of a transmitter's ability to inhibit the generation of the intermodulation products.

### Measurement Method

The intermodulation measurement measures the third-order and fifth-order intermodulation products caused by the wanted signal and the interfering signal. These intermodulation products are generated by the nonlinear devices or circuits in a transmitter. The measured results are evaluated as a ratio, relative to the carrier power.

There are two types of intermodulation:

- Two-tone - Measurements are made assuming two CW signals to be the tone signals.
- Transmit IM - Measurements are made assuming that one signal is the modulated transmitting signal and another is the CW signal.

This measurement automatically identifies either two-tone intermodulation mode or transmit intermodulation mode at the start of measurements. The fundamental signals, lower and upper, are automatically searched every sweep to calculate the proper results. When a measurement starts, the highest two peaks at frequency  $f_0$  and  $f_1$  are searched within a given span. Based on these frequencies, the frequencies associated with the possible third-order and fifth-order intermodulation products are calculated. The power bandwidth is checked to determine if the mode is two-tone intermodulation or transmit intermodulation.

The results are displayed both as relative power in dBc, and as absolute power in dBm. For transmit intermodulation products, the result is also shown as the power spectral density in dBm/MHz.

### Troubleshooting Hints

Intermodulation distortion (IM) measurements can reveal the presence of degraded or defective parts in the transmitter section of the UUT. The following are examples of problems which, once indicated by IM testing, may require further attention:

- Faulty DC power supply control of the transmitter power amplifier.
- RF power controller of the pre-power amplifier stage.
- I/Q control of the baseband stage.
- Reduction in the gain and output power level of the amplifier due to a degraded gain control and/or increased distortion.
- Degradation of amplifier linearity and other performance characteristics.

Power amplifiers are one of the final stage elements of a base or mobile transmitter and play a critical part in meeting the important power and spectral efficiency specifications. Measuring the spectral response of these amplifiers to complex wideband signals is crucial to linking amplifier linearity and other performance characteristics to the stringent system specifications.

## Modulation Accuracy (Composite Rho) Measurement Concepts

### Purpose

Rho is one of the key modulation quality metrics, along with EVM and code domain power. Rho is the ratio of the correlated power in a single coded channel to the total signal power. This is a simplified case of code domain power since this measurement is made on a single coded channel. This measurement takes into account all possible error mechanisms in the entire transmission chain including baseband filtering, I/Q modulation anomalies, filter amplitude and phase non-linearities, and power amplifier distortion. This provides an overall indication of the performance level of the transmitter of the UUT.

### Measurement Method

This procedure measures the performance of the transmitter’s modulation circuitry.

In a digitally modulated signal, it is possible to predict what the ideal magnitude and phase of the carrier should be at any time, based on the transmitted data sequence. The transmitter’s modulated signal is compared to an ideal signal vector. The difference between these two vectors is sampled and processed using DSP. Rho values are in the range of 0.000 to 1.000. A value of 1.000 indicates perfect correlation to the reference (high modulation quality).

Depending on the test equipment for MS, it is recommended that you use the trigger output signal from the instrument for synchronization.

If the error code 604 “Can not correlate to input signal” is shown, it means that your measurement has failed to find any active channels due to the lack of correlation with the input signal. The input signal level, for example, may need to be adjusted to obtain correlation.

With the Result Metrics view, the following data is provided:

Result Items	Example data shown
Rho	0.99801
EVM	4.48%rms            11.47%pk
Pk CDE	-48.71 dB at W128(100):I
Magnitude Error	3.24%rms
Phase Error	10.31°rms
Freq Error	-49.12 Hz
I/Q Origin Offset	-53.73 dB

Concepts

Result Items	Example data shown	
Pilot Offset	-2826.83 $\mu$ s	
Active Channels	9	
Max Inactive Ch	-49.58 dBc at W16(12):Q	
<b>Active CH</b>	<b>Code Domain Pwr</b>	<b>Pwr Ref to Pilot</b>
Pilot W16(0):I	-10.02 dBc	Reference
RRI W16(0):I	-10.02 dBc	0.00 dB
ACK W8(4):I	-7.02 dBc	-3.02 dB
DRC W16(8):Q	-7.06 dBc	-2.98 dB
Data W4(2):Q	-6.26 dBc	-3.76 dB

---

## Occupied Bandwidth Measurement Concepts

### Purpose

Occupied bandwidth measurements express the percentage of the transmitted power within a specified bandwidth. This percentage is typically 99%.

The spectrum shape of a 1xEV-DO signal can give useful qualitative insight into transmitter operation. Any distortion to the spectrum shape can indicate problems in transmitter performance.

### Measurement Method

The instrument uses digital signal processing (DSP) to sample the input signal and convert it to the frequency domain. With the instrument tuned to a fixed center frequency, samples are digitized at a high rate with DSP hardware, and then converted to the frequency domain with FFT software.

The total power within the measurement frequency span is integrated for its 100% of power. The frequencies of 0.5% of the total power are then calculated to get 99.0% bandwidth.

---

## Power Statistics CCDF Measurement Concepts

### Purpose

Many of the digitally modulated signals now look noise-like in the time and frequency domain. This means that statistical measurements of the signals can be a useful characterization. Power Complementary Cumulative Distribution Function (CCDF) curves characterize the higher-level power statistics of a digitally-modulated signal. The curves can be useful in determining design parameters for digital communications systems.

The power statistics CCDF measurement can be affected by many factors. For example, modulation filtering, modulation format, combining the multiple signals at different frequencies, number of active codes and correlation between symbols on different codes with spread spectrum systems. These factors are all related to modulation and signal parameters. External factors such as signal compression and expansion by non-linear components, group delay distortion from filtering, and power control within the observation interval also affect the measurement.

### Measurement Method

The power measured in power statistics CCDF curves is actually instantaneous envelope power defined by the equation:

$$P = (I^2 + Q^2)/Z_0$$

(where I and Q are the quadrature voltage components of the waveform and  $Z_0$  is the characteristic impedance).

A CCDF curve is defined by how much time the waveform spends at or above a given power level. The percent of time the signal spends at or above the level defines the probability for that particular power level. To make a power statistics CCDF measurement, the instrument uses digital signal processing (DSP) to sample the input signal in the channel bandwidth.

The Gaussian distribution line as the band-limited gaussian noise CCDF reference line, the user-definable reference trace, and the currently measured trace can be displayed on a semi-log graph. If the currently measured trace is above the user reference trace, it means that the higher peak power levels against the average power are included in the input signal.



---

## Power versus Time Measurement Concepts

### Purpose

A 1xEV-DO cellular system utilizes a variable rate voice coder in order to provide the maximum system capacity. According to the activity in the voice channel the codec varies the data rate. If the voice codec drops below the full rate, 9600 bps for instance, a 1xEV-DO mobile bursts its output power on and off proportionally to the data rate reduction. At a half rate, a mobile transmits 50% of the time, and at one eighth rate, it transmits 12.5% of the time. To prevent the interference caused by bursting the RF carrier, the associated standard specifies a power versus time template to which a mobile must conform.

This template defines the burst length, the rising and falling edges, the masks for regions of power on and power off.

### Measurement Method

As a time domain data acquisition, one burst is captured with a trigger. The rising and falling edges are detected at the crossing points with the burst search threshold level. The burst center point in time is determined, and then the required masks are aligned in time with the center point. To make a precise slope detection, its threshold level and detection interval techniques are incorporated to extract only steep enough slopes out from the noise-like signals.

---

## QPSK EVM Measurement Concepts

### Purpose

Phase and frequency errors are measures of modulation quality for the 1xEV-DO system. This modulation quality is obtained through QPSK Error Vector Magnitude (EVM) measurements. Since the 1xEV-DO system uses Quadrature Phase Shift Keying (QPSK) modulation, the phase and frequency accuracies of the transmitter are critical to the communications system performance and ultimately affect range.

1xEV-DO receivers rely on the phase and frequency quality of the QPSK modulation signal in order to achieve the expected carrier to noise ratio. A transmitter with high phase and frequency errors will often still be able to support phone calls during a functional test. However, it will tend to cause difficulty for mobiles trying to maintain service at the edge of the cell with low signal levels or under difficult fading and Doppler conditions.

### Measurement Method

The input signal needs to be a single coded signal, such as a pilot channel. The phase error of the unit under test is measured by computing the difference between the phase of the transmitted signal and the phase of a theoretically perfect signal.

The instrument samples the transmitter output in order to capture the actual phase trajectory. This is then demodulated and the ideal phase trajectory is mathematically derived using detected bits and channel filtering. Subtracting one from the other results in a phase error signal.

This measurement allows you to display these errors numerically and graphically on the instrument display. There are graphs for EVM, Phase Error and Mag Error in the graph windows. In the text window, there are both maximum and average data for EVM: in % rms, in % peak, RMS Mag Error: in %, Phase Error: in degrees, Freq Error: in Hz, and IQ Offset: in dB.

---

## Spectrum (Frequency Domain) Measurement Concepts

### Purpose

The spectrum measurement provides spectrum analysis capability for the instrument. The control of the measurement was designed to be familiar to those who are accustomed to using swept spectrum analyzers.

This measurement is FFT (Fast Fourier Transform) based. The FFT-specific parameters are located in the **Advanced** menu. Also available under basic mode spectrum measurements is an I/Q window, which shows the I and Q signal waveforms in parameters of voltage versus time. The advantage of having an I/Q view available while in the spectrum measurement is that it allows you to view complex components of the same signal without changing settings or measurements.

### Measurement Method

The measurement uses digital signal processing to sample the input signal and convert it to the frequency domain. With the instrument tuned to a fixed center frequency, samples are digitized at a high rate, converted to I and Q components with DSP hardware, and then converted to the frequency domain with FFT software.

### Troubleshooting Hints

Changes made by the user to advanced spectrum settings, particularly to ADC range settings, can inadvertently result in spectrum measurements that are invalid and cause error messages to appear. Care needs to be taken when using advanced features.

---

## Spurious Emissions and Adjacent Channel Power Measurement Concepts

### Purpose

Spurious Emissions Mask (SEM) & Adjacent Channel Power (ACP) measurements include the in-band and out-of-band adjacent channel power and spurious emissions. ACP, as it applies to 1xEV-DO, is the power contained in a specified frequency channel bandwidth relative to the carrier frequency. It may also be expressed as power spectral densities between the carrier and the specified offset frequency band.

As a composite measurement of out-of-channel emissions, Spurious Emissions and ACP combines both in-band and out-of-band specifications to provide useful values of figure-of-merit for spectral regrowth as well as spurious emissions produced by non-linear components and circuit blocks.

To maintain a quality data transmission and avoid adjacent channel interference, it is necessary to measure and reduce the adjacent channel power transmitted by an access network. The characteristics of adjacent channel power are mainly determined by the transmitter design, in particular the power amplifier and the low-pass filter.

Adjacent channel power is defined by the 1xEV-DO standard as the total power within the bandwidth of  $\pm 15$  kHz, with the filters edge at 750 kHz offset from the carrier frequency.

### Measurement Method

This ACP measurement analyzes the total power levels within the defined carrier bandwidth and at given frequency offsets on both sides of the carrier frequency. Also, the spurious emissions measurement measures spurious signal levels in given offset/region frequencies and relates them to the carrier power. These measurements require the user to specify measurement bandwidths of the carrier channel and each of the offset frequency pairs up to 5. Each pair may be defined with unique measurement bandwidths.

A reference channel integration bandwidth method is used to measure the carrier channel power and offset/region powers. When “ACP” is selected, the adjacent channel power measurements are made with the optimized region and limits settings. When “SEM” is selected, the conducted spurious emissions measurements are made with the optimized parameter settings.

This integration bandwidth (IBW) method performs a data acquisition. In this process, the reference channel integration bandwidth (**Meas BW**) is analyzed using the automatically defined resolution bandwidth (**Res**

**BW**), which is much narrower than the channel bandwidth. The measurement computes an average power of the channel or offset or region over a specified number of data acquisitions, automatically compensating for resolution bandwidth and noise bandwidth.

When you set the measurement type to **Total Pwr Ref**, the results are displayed as relative power in dBc and as absolute power in dBm. When you set it to **PSD Ref** (Power Spectral Density Reference), the results are displayed as relative power in dB and as absolute power in dBm/Hz.

---

## Waveform (Time Domain) Measurement Concepts

### Purpose

The waveform measurement is a generic measurement for viewing the input signal waveforms in the time domain. This measurement is how the instrument performs the zero span functionality found in traditional spectrum analyzers.

Basic mode waveform measurement data may be displayed using either a Signal Envelope window, or an I/Q window which shows the I and Q signal waveforms in parameters of voltage versus time. The advantage of having an I/Q view available while making a waveform measurement is that it allows you to view complex components of the same signal without changing settings or measurements.

For E4406A, an I/Q Polar display is also available to view the I and Q waveforms in a polar plot. This display shows the instantaneous relationship between the I and Q waveform voltages.

The waveform measurement can be used to perform general purpose power measurements in the time domain with excellent accuracy.

### Measurement Method

The instrument makes repeated power measurements at a set frequency, similar to the way a swept-tuned spectrum analyzer makes zero span measurements. The input analog signal is converted to a digital signal, which then is processed into a representation of a waveform measurement. The measurement relies on a high rate of sampling to create an accurate representation of a time domain signal.

---

## Other Sources of Measurement Information

Additional measurement application information is available through your local Agilent Technologies sales and service office. The following application notes treat digital communications measurements in much greater detail than is discussed in this measurement guide.

- Application Note 1298  
Digital Modulation in Communications Systems - An Introduction  
Agilent part number 5965-7160E
- Application Note 1311  
Understanding CDMA Measurements for Base Stations and Their Components  
Agilent part number 5968-0953E
- Application Note 1325  
Performing cdma2000 Measurements Today  
Agilent part number 5968-5858E

### Instrument Updates at [www.agilent.com](http://www.agilent.com)

These web locations can be used to access the latest information about the instrument, including the latest firmware version.

<http://www.agilent.com/find/psa>

<http://www.agilent.com/find/vsa>





---

---

# 6

## Menu Maps

Mode function menu maps are presented first. Measurement menu maps follow in alphabetical order of the front panel key label or oval cross-reference label. You can locate detailed information about each key/function at the page number listed in the figure title for each menu.

---

## 1xEV-DO Measurement Key Flow

The Menu Map diagrams, shown in a hierarchical manner on the following pages, will help grasp the overall functional relationships for the front-panel keys and the keys displayed at the extreme right side of the screen. The diagrams are:

- “MODE Selection Key Flow” on page 612
- “Mode Setup/FREQUENCY Channel Key Flow (1 of 2)” on page 613
- “Measurement Selection Key Flow” on page 615
- “Channel Power Measurement Key Flow” on page 616
- “Forward Link Code Domain Measurement Key Flow (1 of 3)” on page 617
- “Forward Link Mod Accuracy Measurement Key Flow (1 of 5)” on page 620
- “Intermodulation Measurement Key Flow” on page 625
- “Occupied Bandwidth Measurement Key Flow” on page 626
- “Power Statistics CCDF Measurement Key Flow” on page 627
- “Power vs. Time Measurement Key Flow (1 of 2)” on page 628
- “QPSK EVM Measurement Key Flow (1 of 2)” on page 630
- “Reverse Link Code Domain Measurement Key Flow (1 of 3)” on page 632
- “Reverse Link Mod Accuracy Measurement Key Flow (1 of 4)” on page 635
- “Spectrum (Freq Domain) Measurement Key Flow (1 of 4)” on page 639
- “Spurious Emissions & ACP Measurement Key Flow (1 of 3)” on page 643
- “Waveform (Time Domain) Measurement Key Flow (1 of 2)” on page 646

## How to Read Menu Map Diagrams

- Key Symbols:

View/Trace

An oval represents one of the front-panel keys.

QPSK EVM

This box represents one of the menu keys displayed.

<for EVM>

This represents an explanatory description for a specific key.

Avg Number 10 On/Off

This box shows a key with its default condition displayed. Default parameters or values are underlined wherever possible.

- Start from the upper left corner of each measurement diagram. Go to the right, and go from the top to the bottom.
- For keys that show Auto and Man(ual) settings, the default is usually Auto. To change the setting to Man, only one key press is required. The variable may then be changed by using either the front-panel keypad of the rotary dial.
- When entering a numeric value for a key, for example **FREQUENCY Channel**, use the numeric keypad and terminate the entry with the appropriate unit selected from those displayed.
- When entering a numeric value without a unit, like **Avg Number**, use the numeric keypad and terminate the entry with the **Enter** front-panel key.
- Instead of using the numeric keypad to enter a value, it may be easier to use the rotary dial or the Up/Down keys.

## Menu Map Diagrams

Figure 6-1 MODE Selection Key Flow

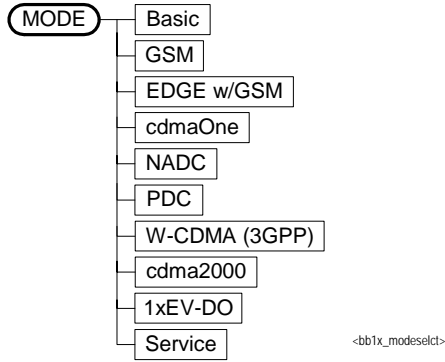


Figure 6-2 Mode Setup/FREQUENCY Channel Key Flow (1 of 2)

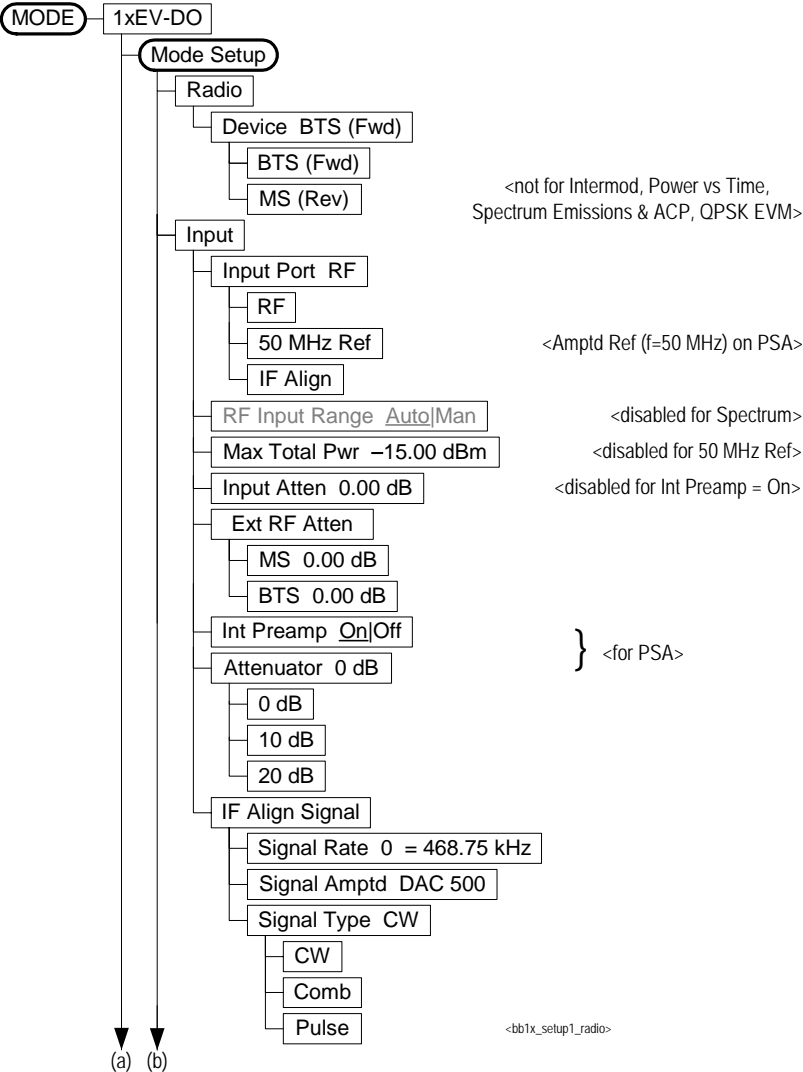


Figure 6-3 Mode Setup/FREQUENCY Channel Key Flow (2 of 2)

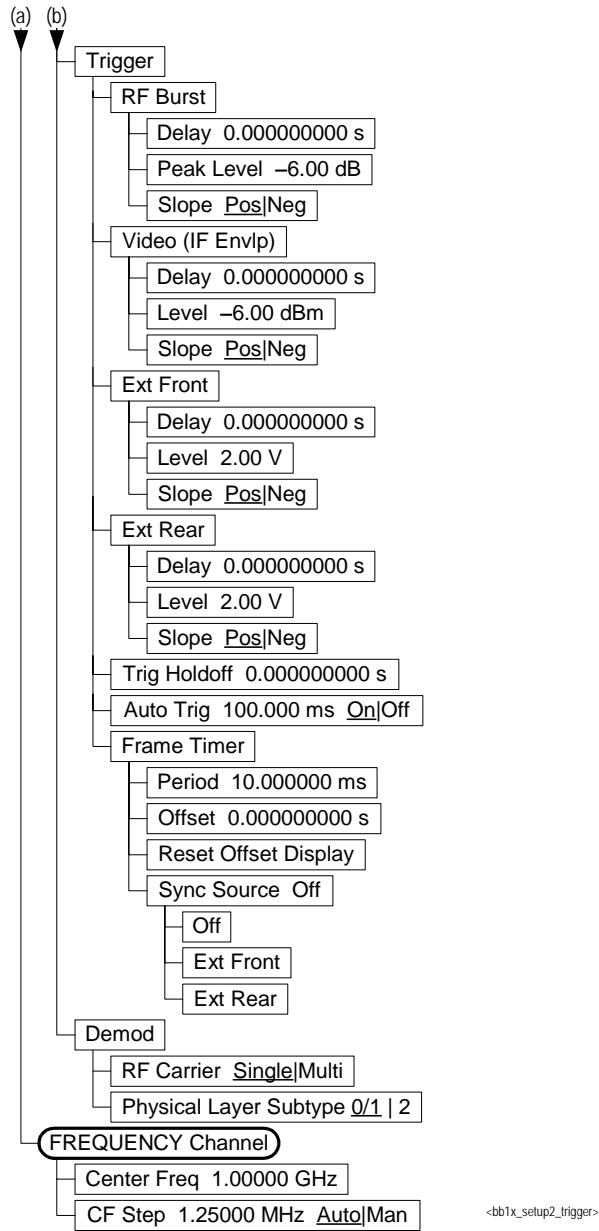


Figure 6-4 Measurement Selection Key Flow

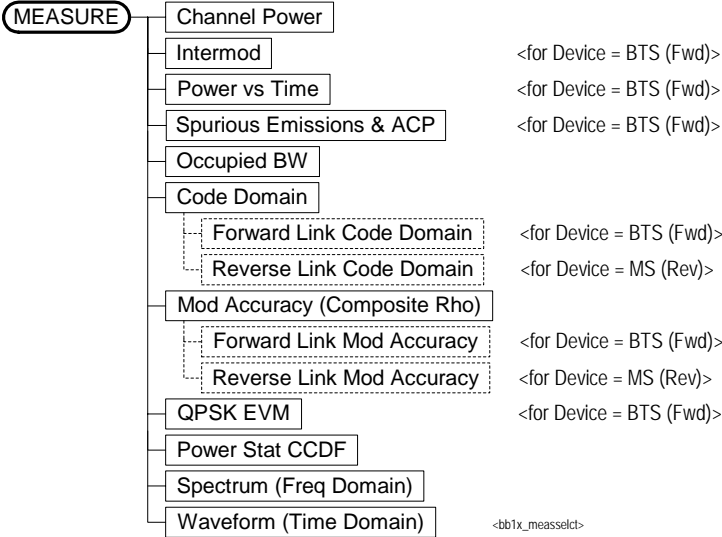


Figure 6-5 Channel Power Measurement Key Flow

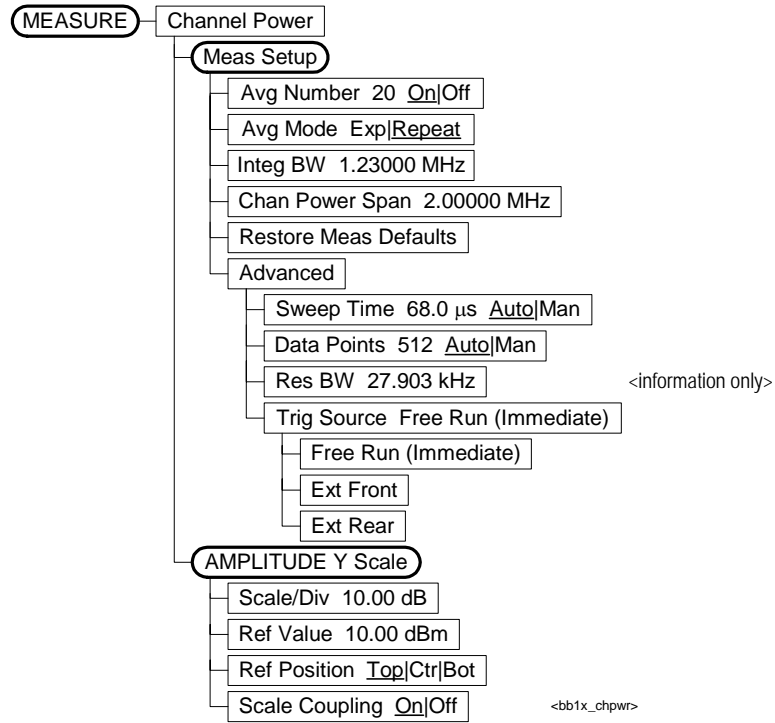
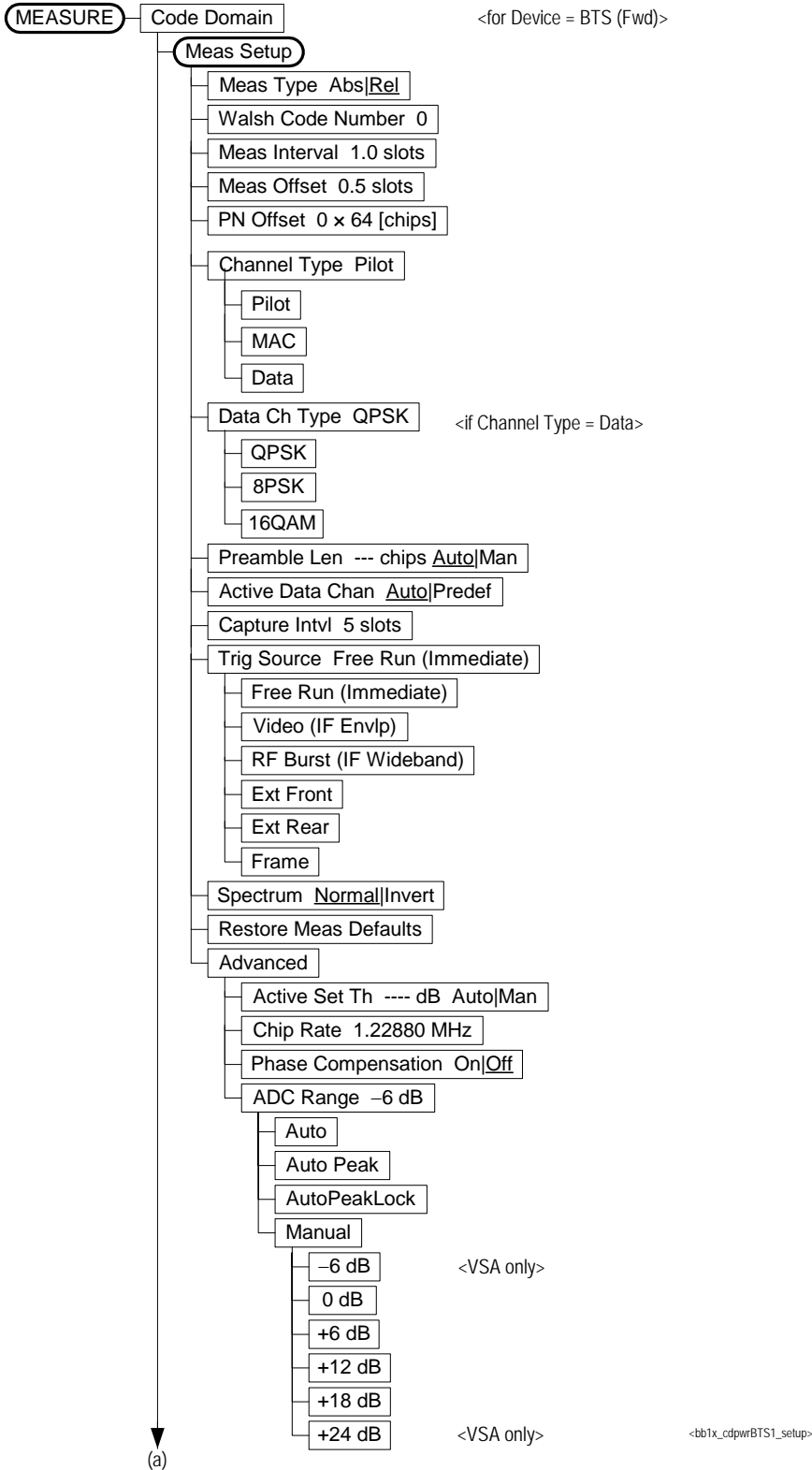




Figure 6-6 Forward Link Code Domain Measurement Key Flow (1 of 3)



**Figure 6-7 Forward Link Code Domain Measurement Key Flow (2 of 3)**

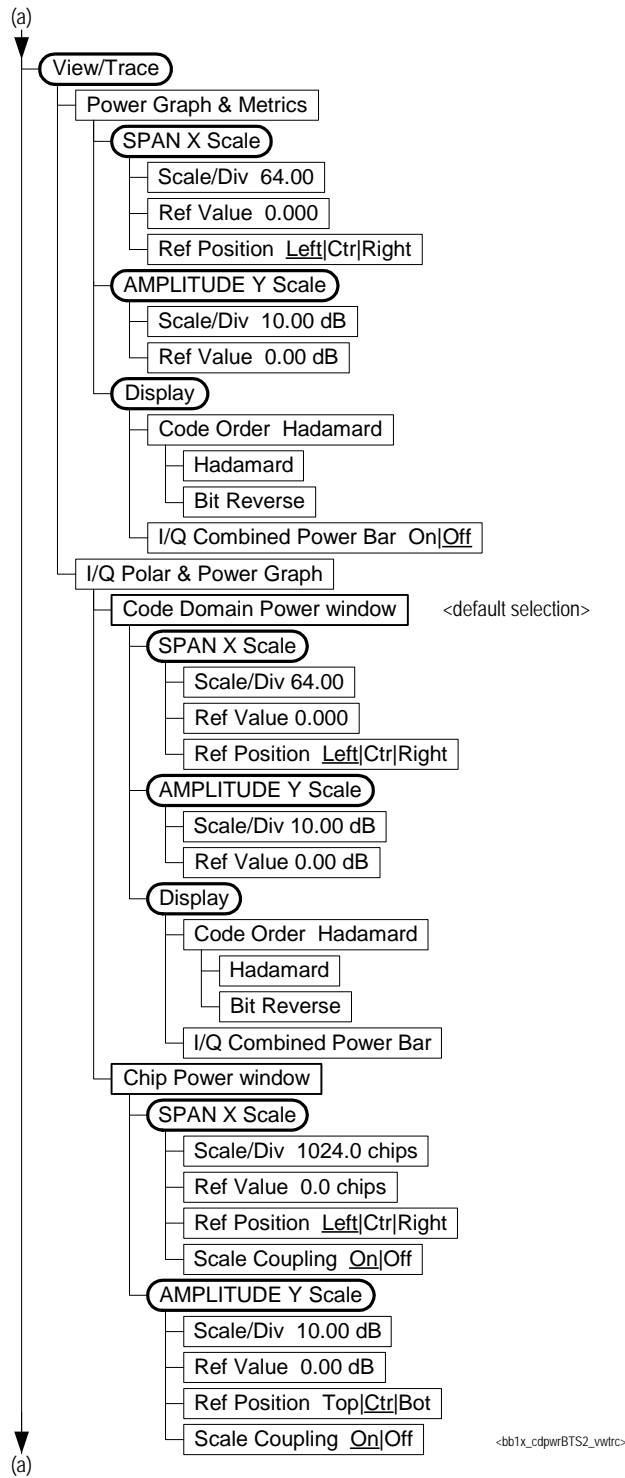
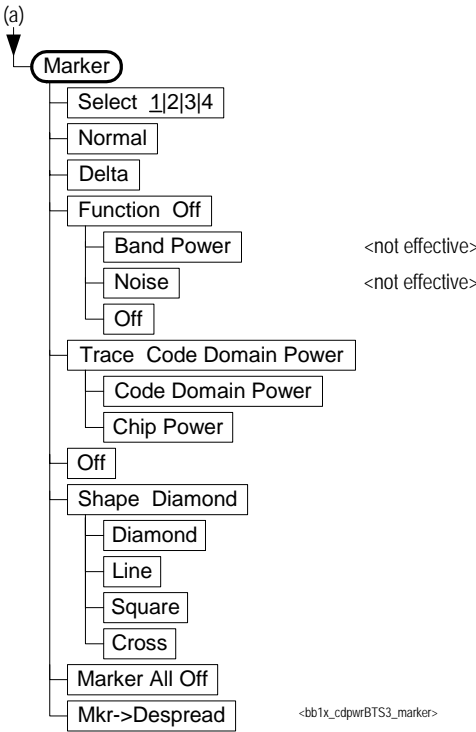


Figure 6-8 Forward Link Code Domain Measurement Key Flow (3 of 3)



**Figure 6-9 Forward Link Mod Accuracy Measurement Key Flow (1 of 5)**

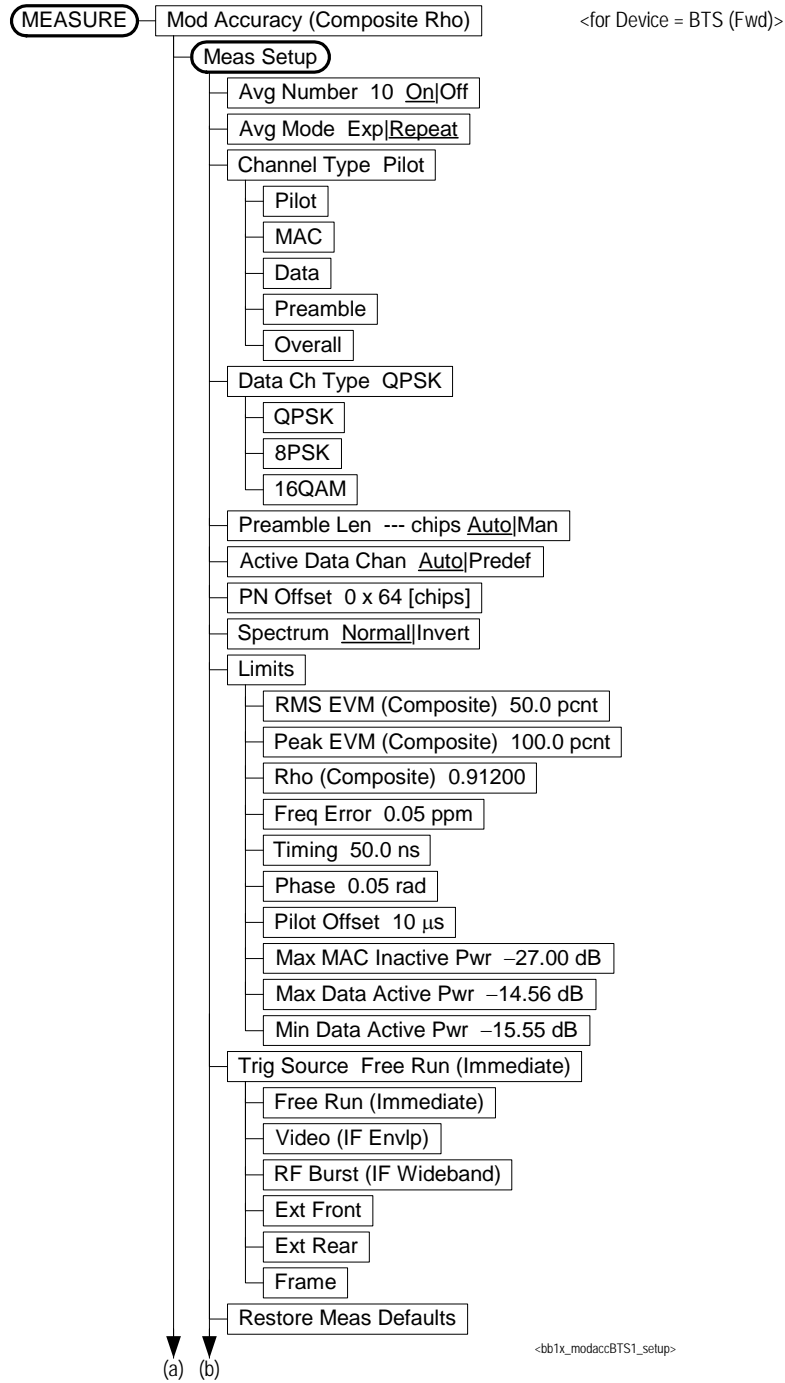
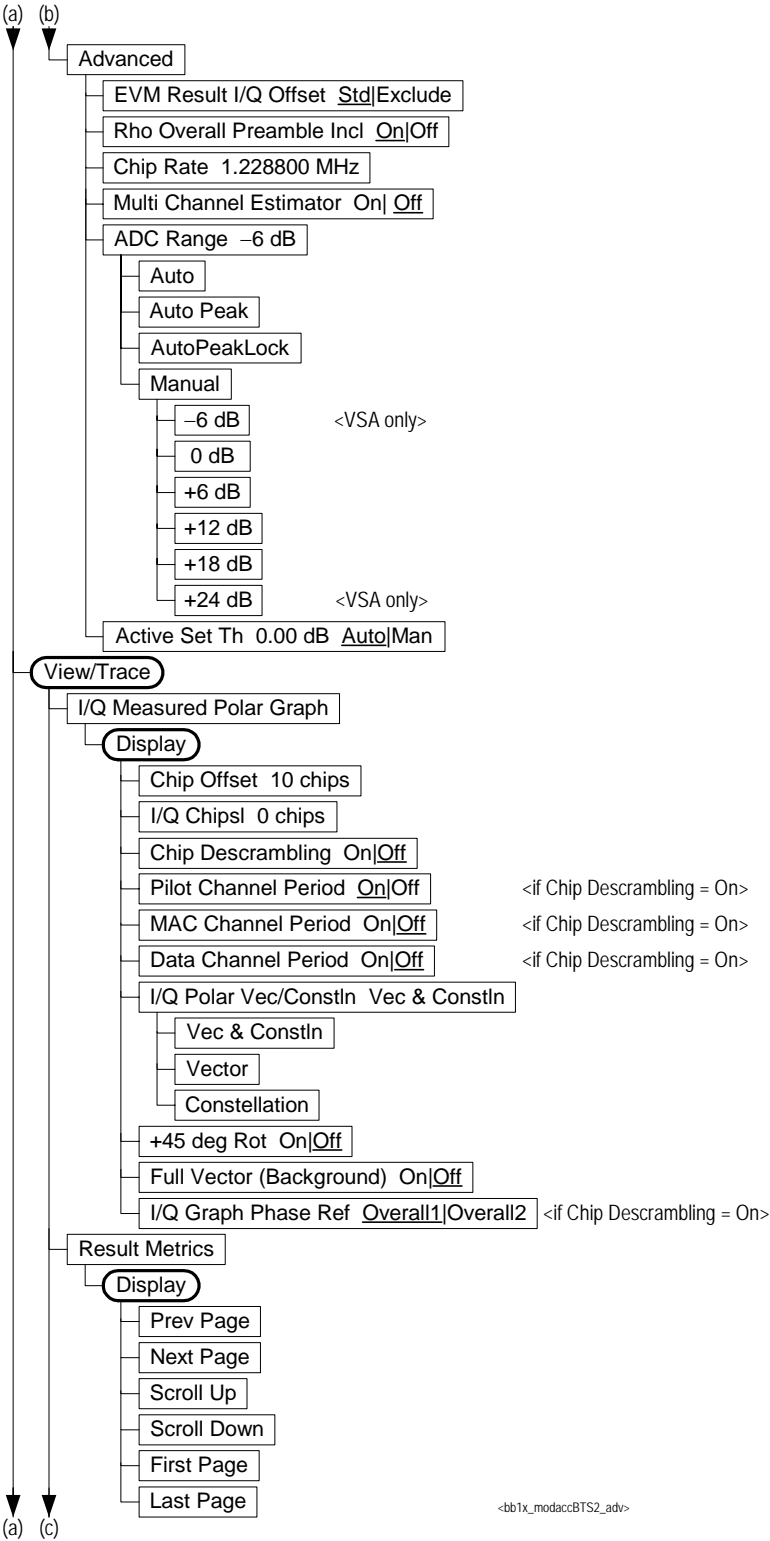
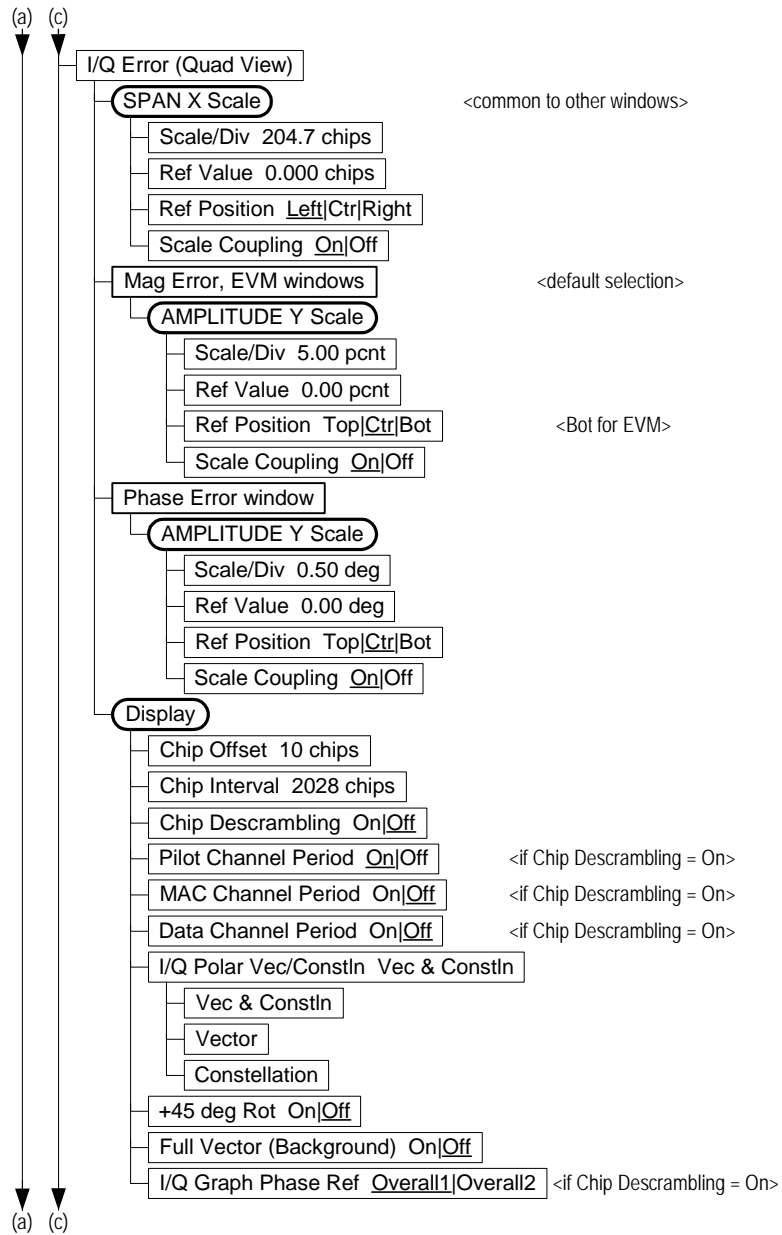


Figure 6-10 Forward Link Mod Accuracy Measurement Key Flow (2 of 5)



<bb1x\_modaccBTS2\_adv>

**Figure 6-11 Forward Link Mod Accuracy Measurement Key Flow (3 of 5)**



<bb1x\_modaccBTS3\_lqerr>

Figure 6-12 Forward Link Mod Accuracy Measurement Key Flow (4 of 5)

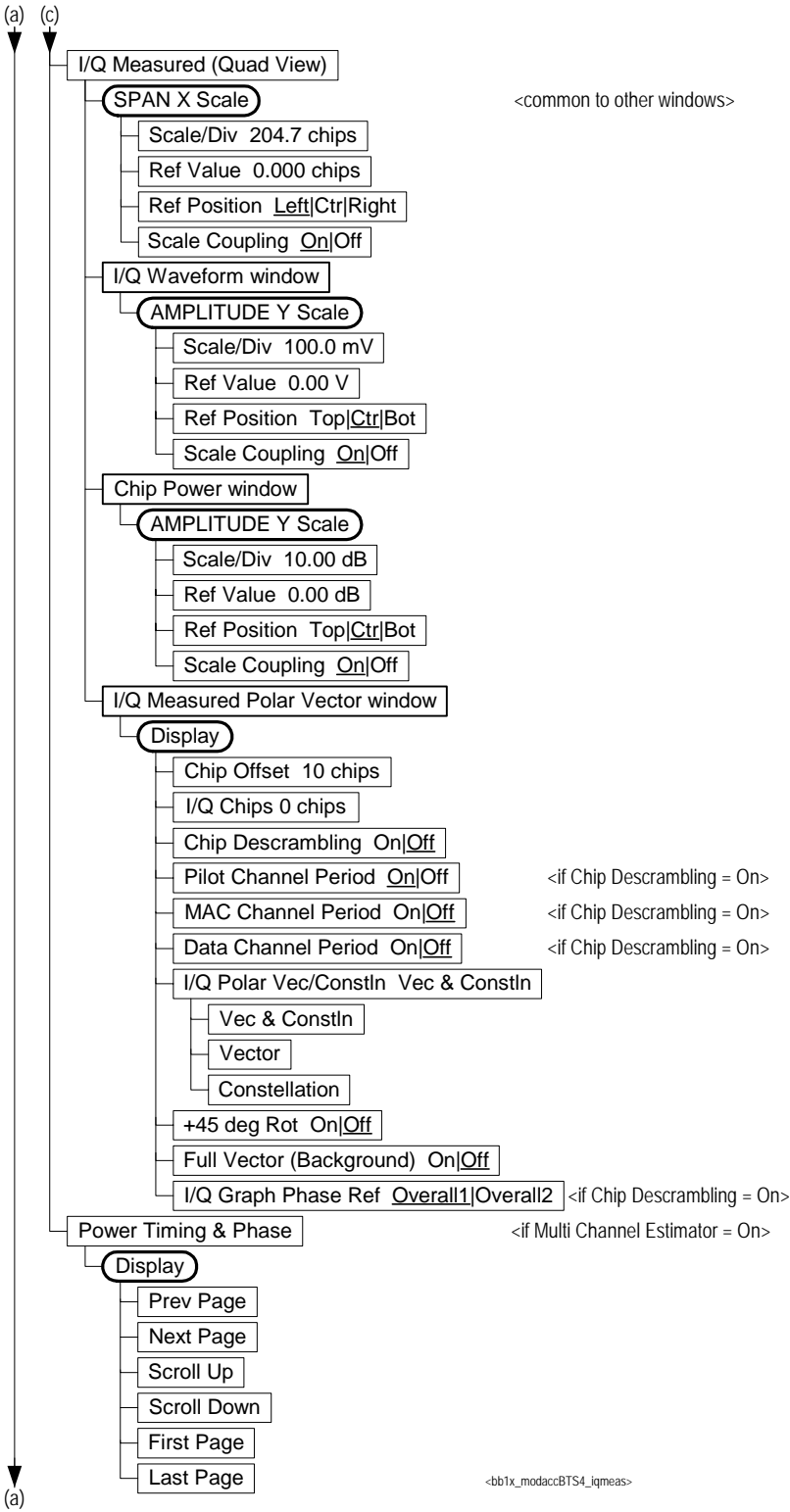


Figure 6-13 Forward Link Mod Accuracy Measurement Key Flow (5 of 5)

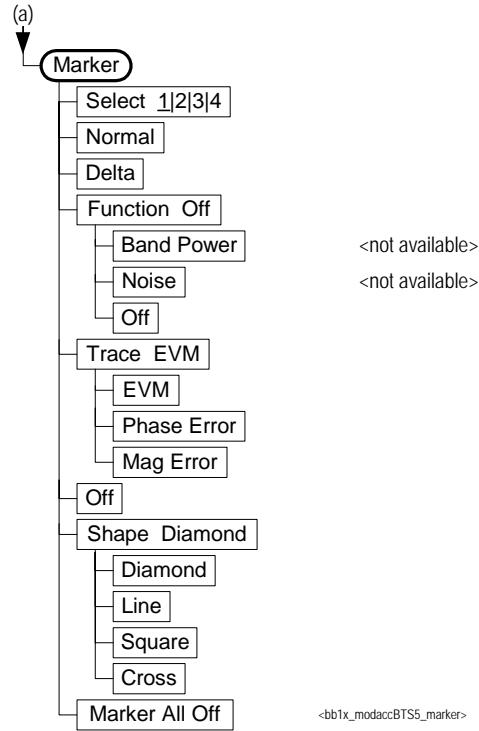




Figure 6-14 Intermodulation Measurement Key Flow

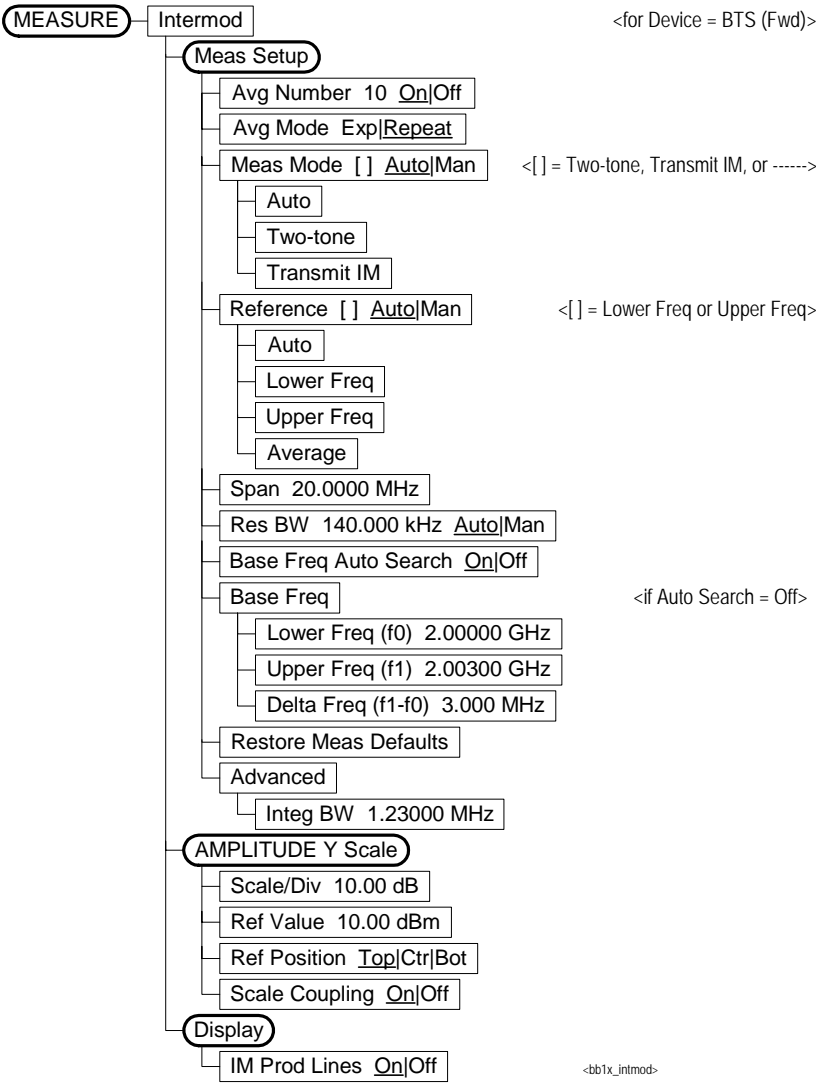


Figure 6-15 Occupied Bandwidth Measurement Key Flow

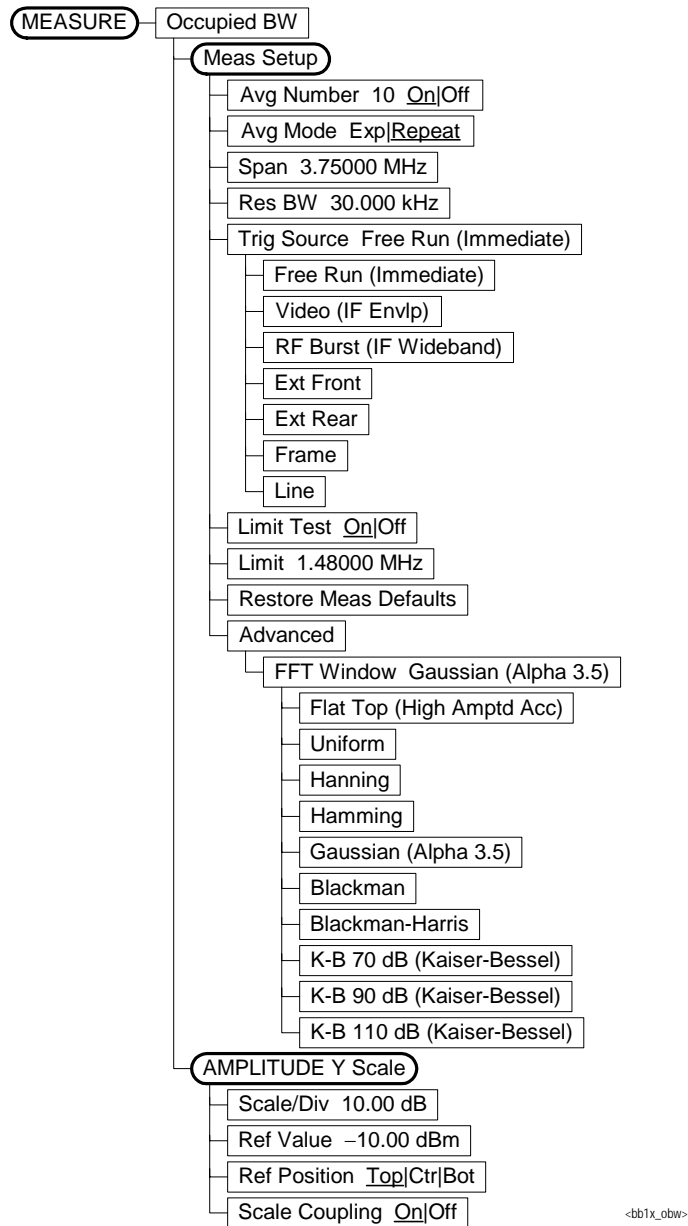
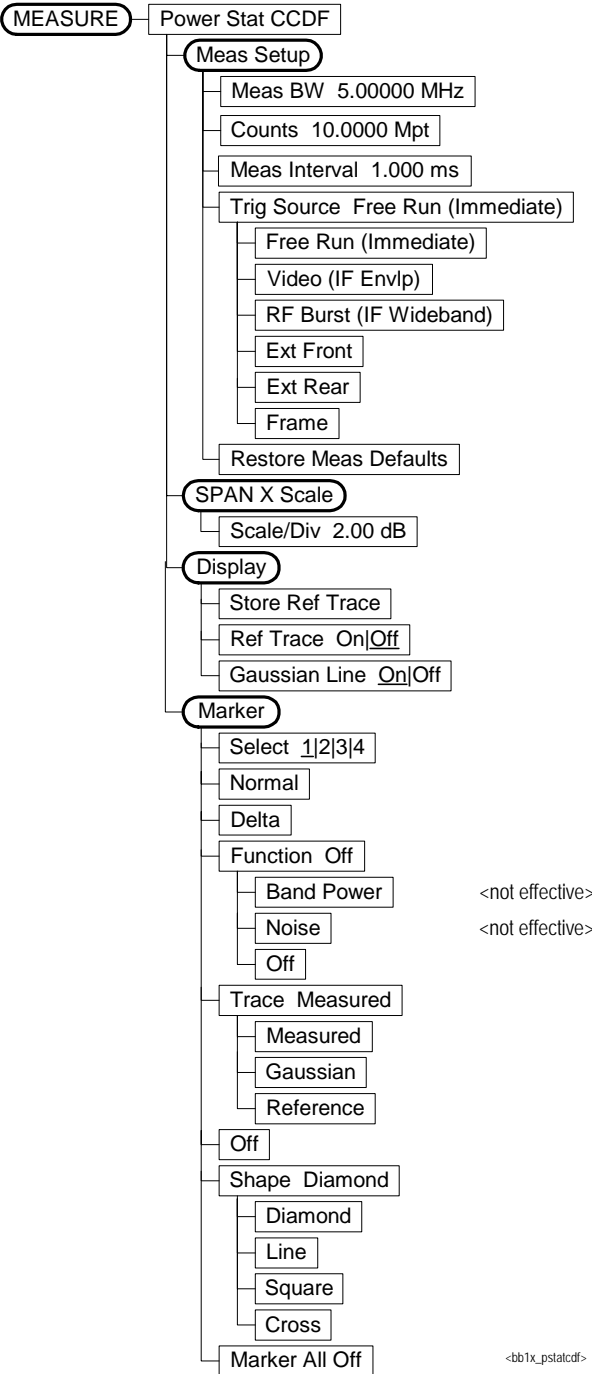


Figure 6-16 Power Statistics CCDF Measurement Key Flow



**Figure 6-17 Power vs. Time Measurement Key Flow (1 of 2)**

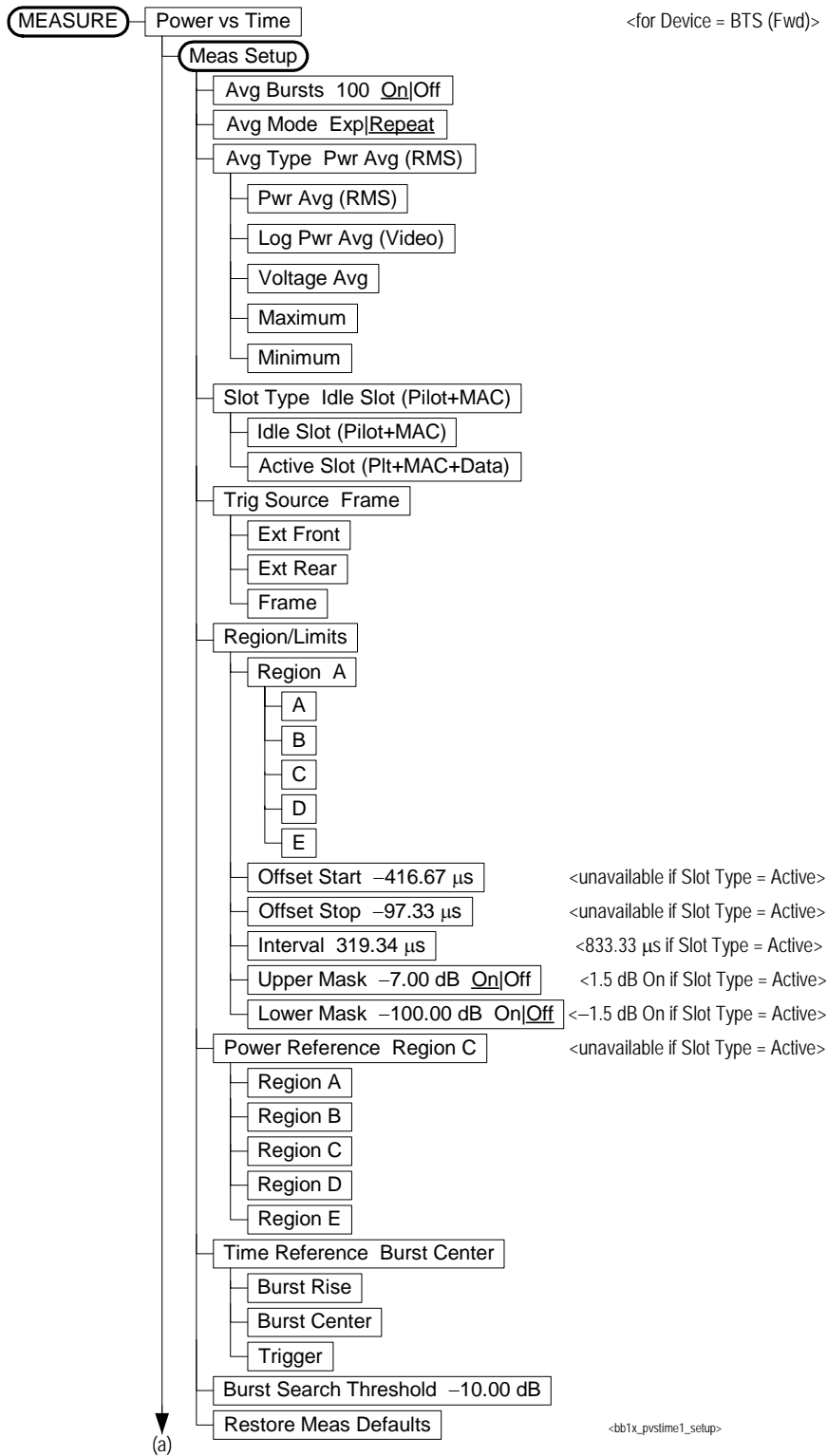
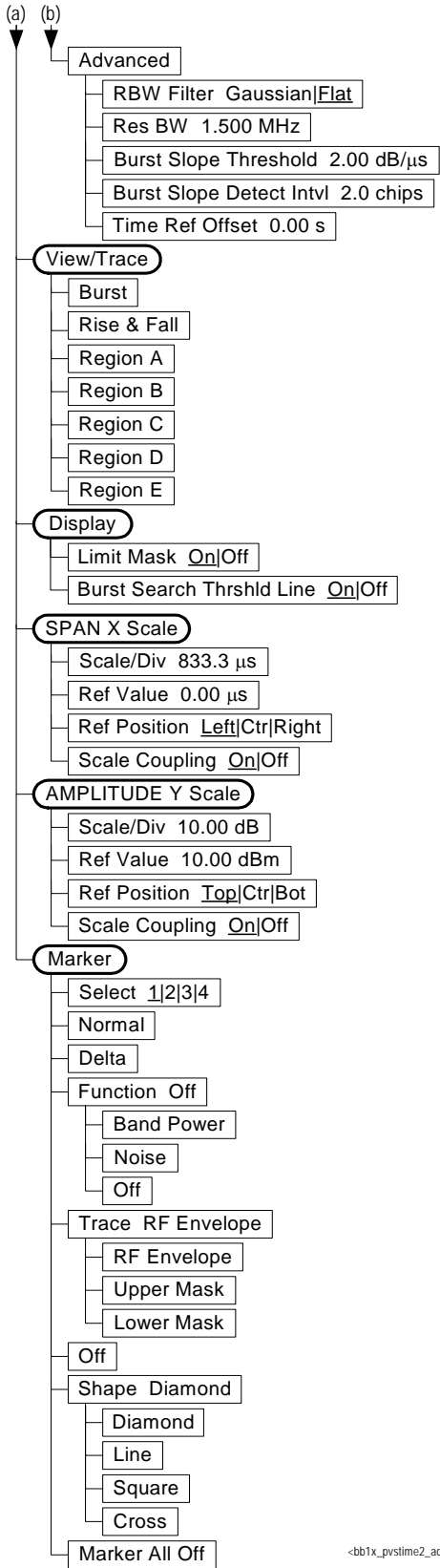


Figure 6-18 Power vs. Time Measurement Key Flow (2 of 2)



**Figure 6-19 QPSK EVM Measurement Key Flow (1 of 2)**

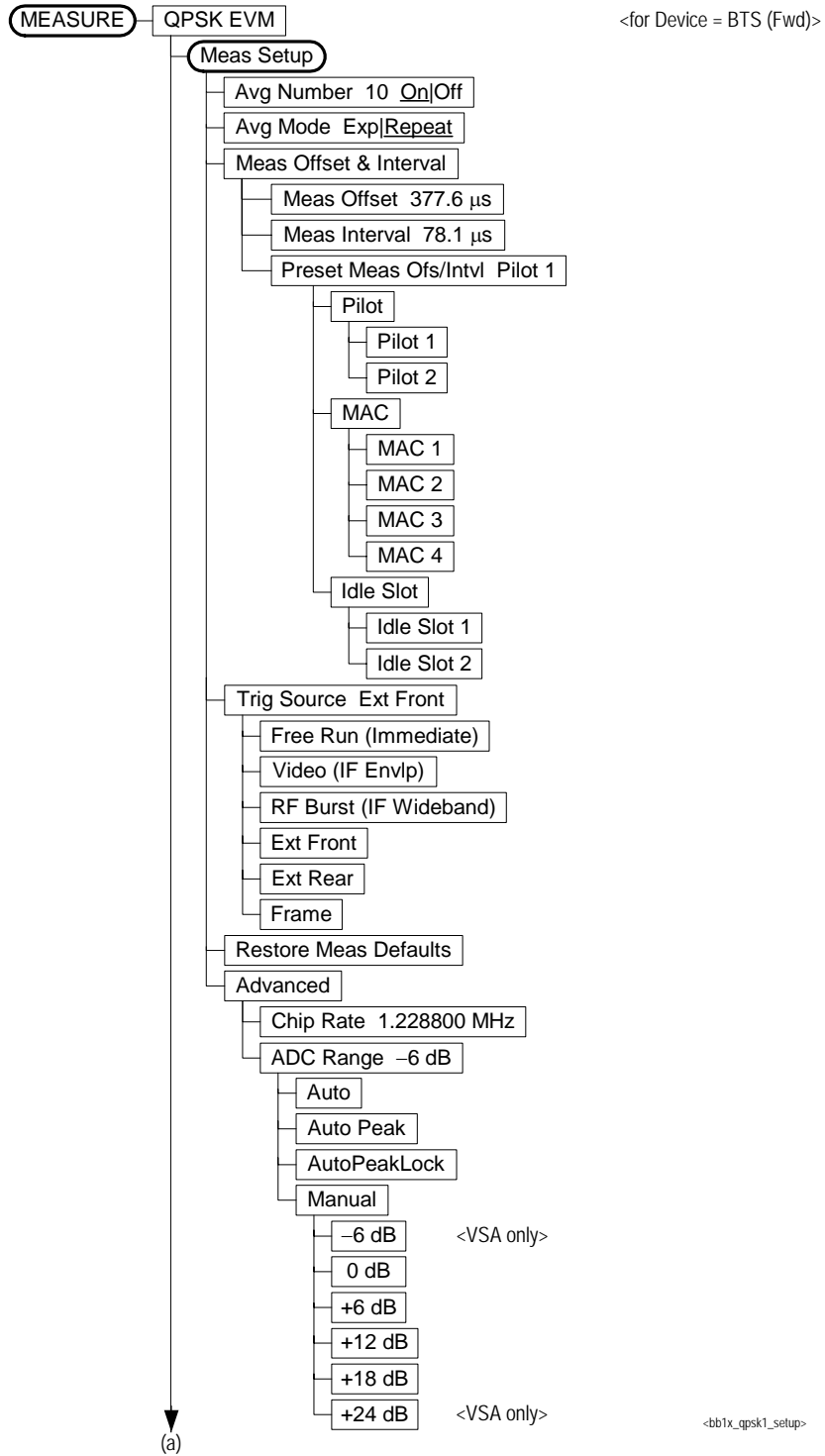
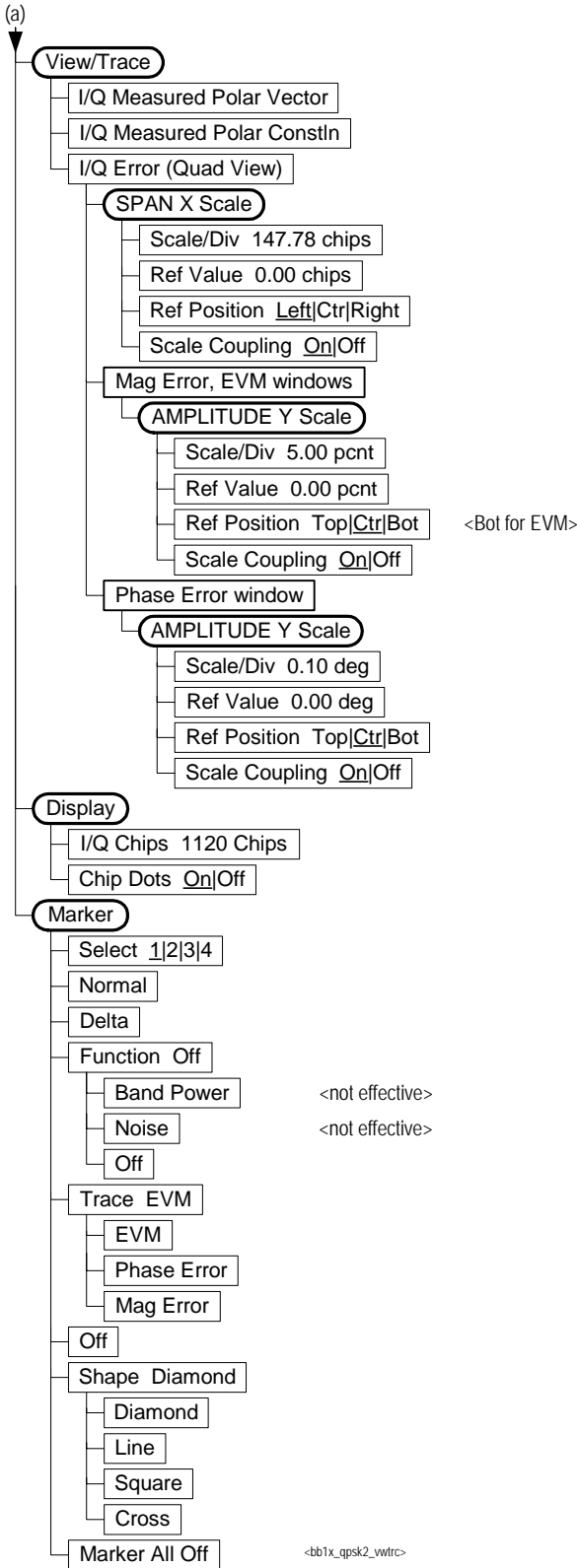
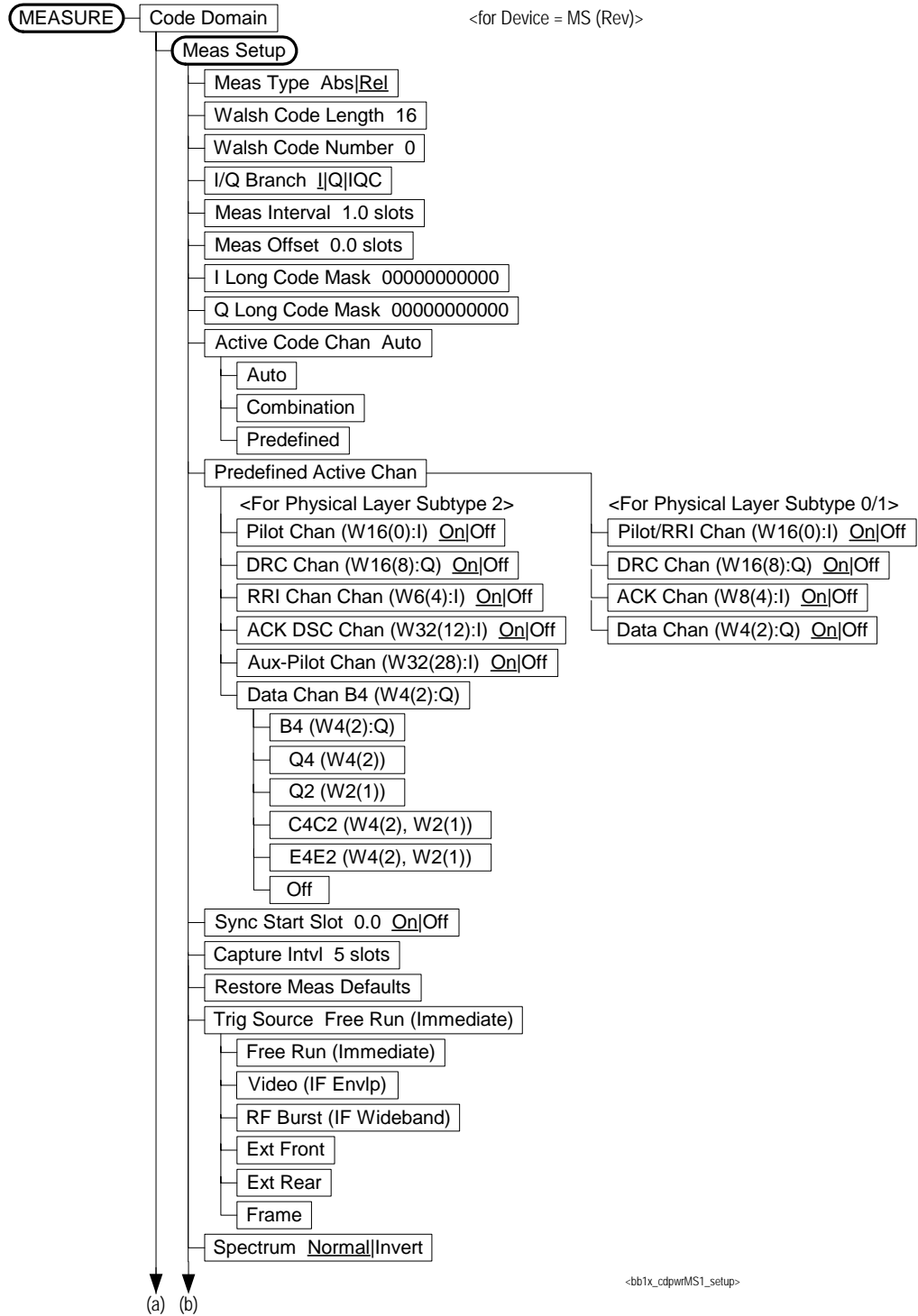


Figure 6-20 QPSK EVM Measurement Key Flow (2 of 2)



**Figure 6-21 Reverse Link Code Domain Measurement Key Flow (1 of 3)**

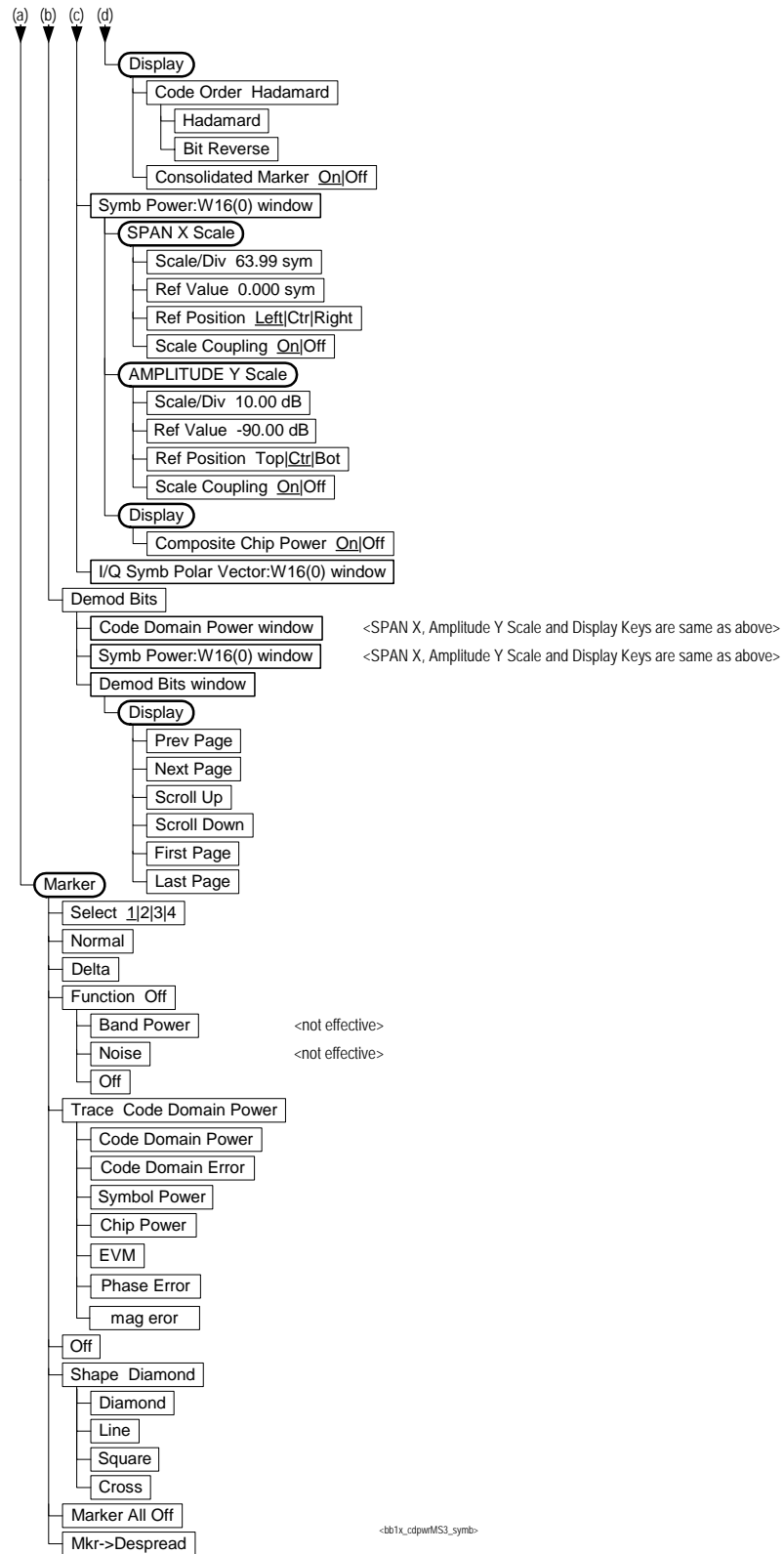




**Figure 6-22 Reverse Link Code Domain Measurement Key Flow (2 of 3)**



**Figure 6-23 Reverse Link Code Domain Measurement Key Flow (3 of 3)**



**Figure 6-24 Reverse Link Mod Accuracy Measurement Key Flow (1 of 4)**

Figure 6-25 Reverse Link Mod Accuracy Measurement Key Flow (2 of 4)

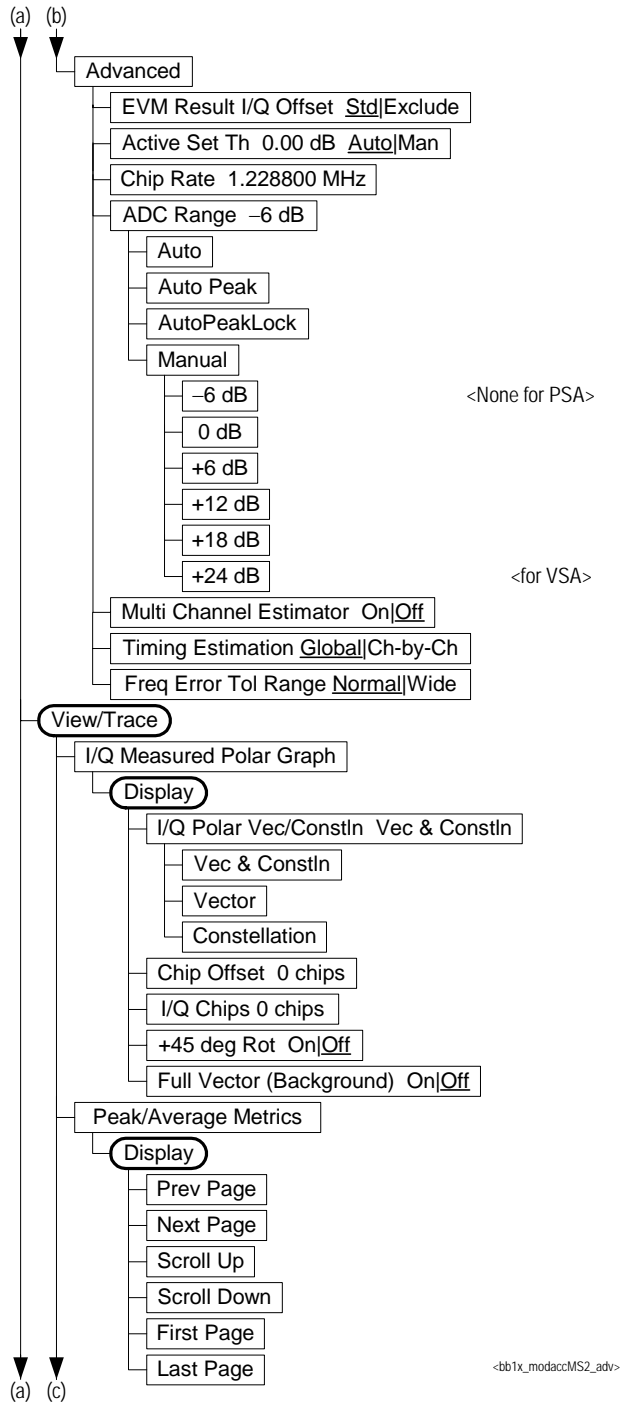
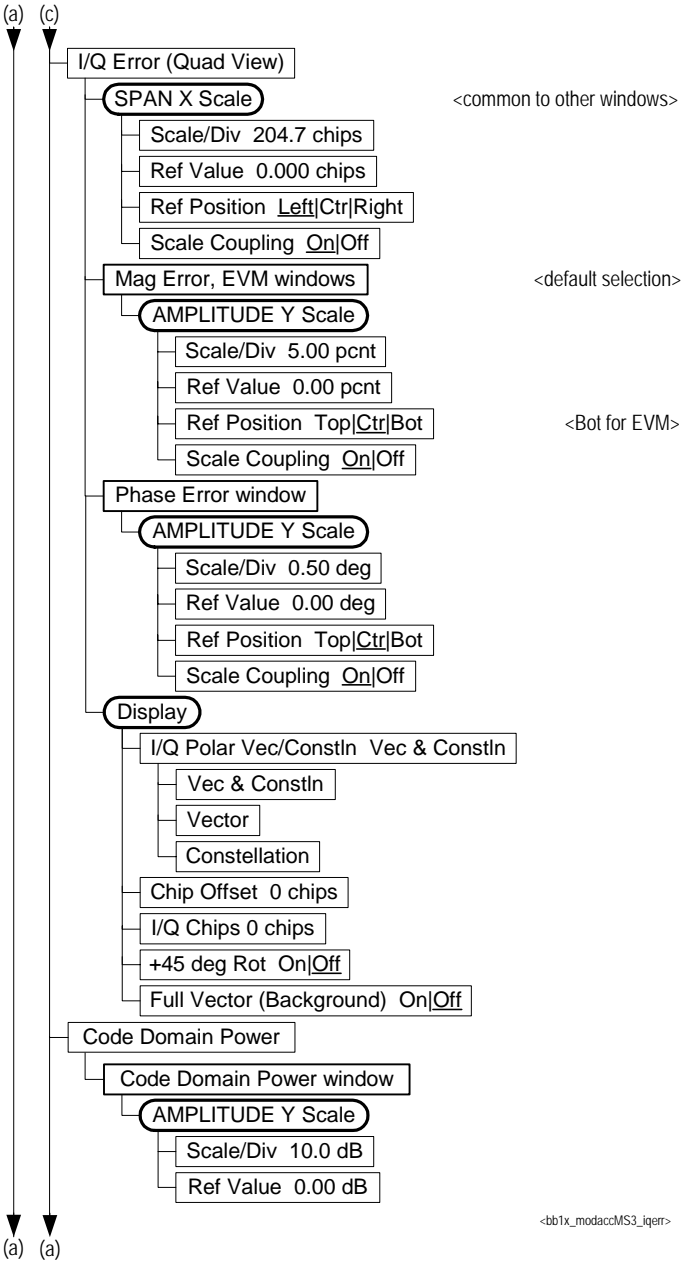


Figure 6-26 Reverse Link Mod Accuracy Measurement Key Flow (3 of 4)



**Figure 6-27 Reverse Link Mod Accuracy Measurement Key Flow (4 of 4)**

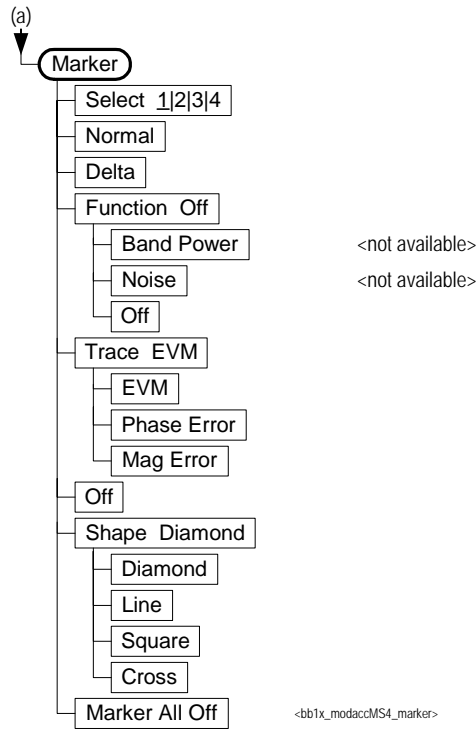


Figure 6-28 Spectrum (Freq Domain) Measurement Key Flow (1 of 4)

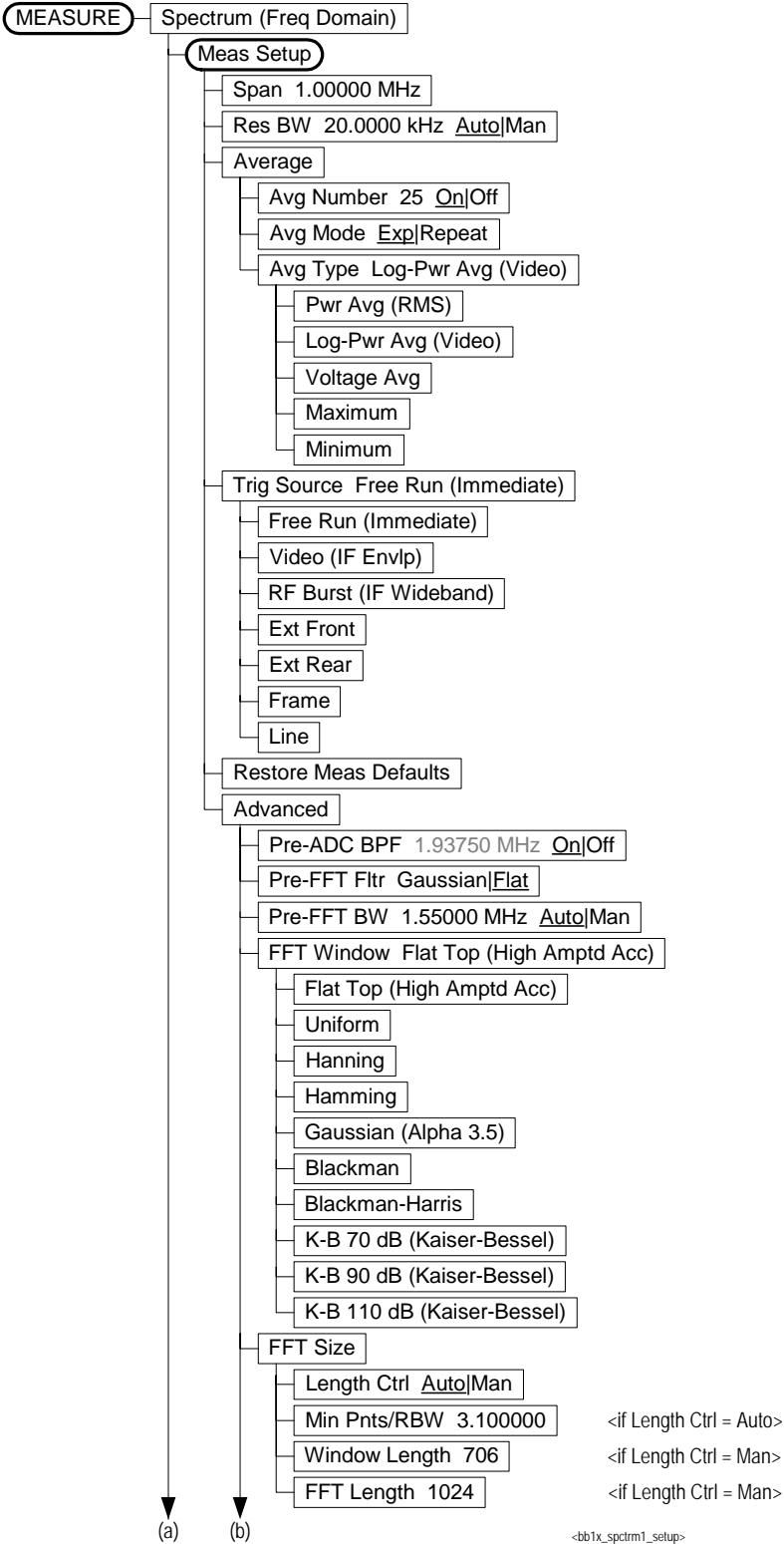


Figure 6-29 Spectrum (Freq Domain) Measurement Key Flow (2 of 4)

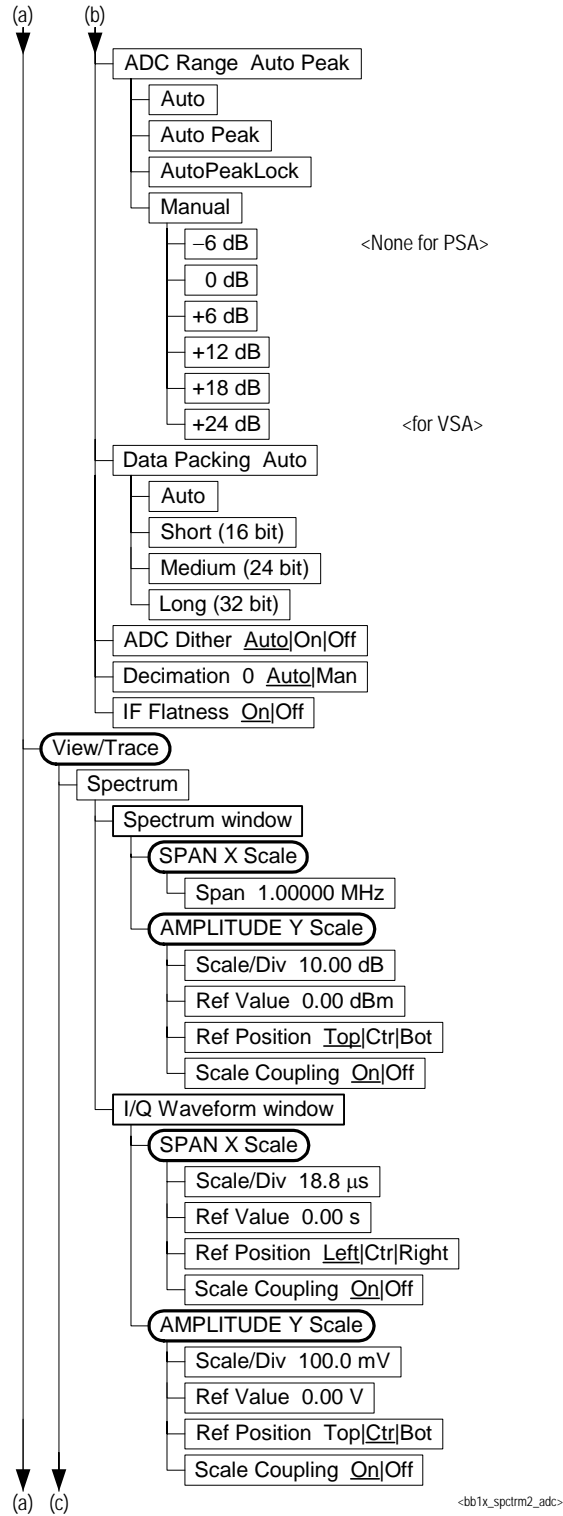




Figure 6-30 Spectrum (Freq Domain) Measurement Key Flow (3 of 4)

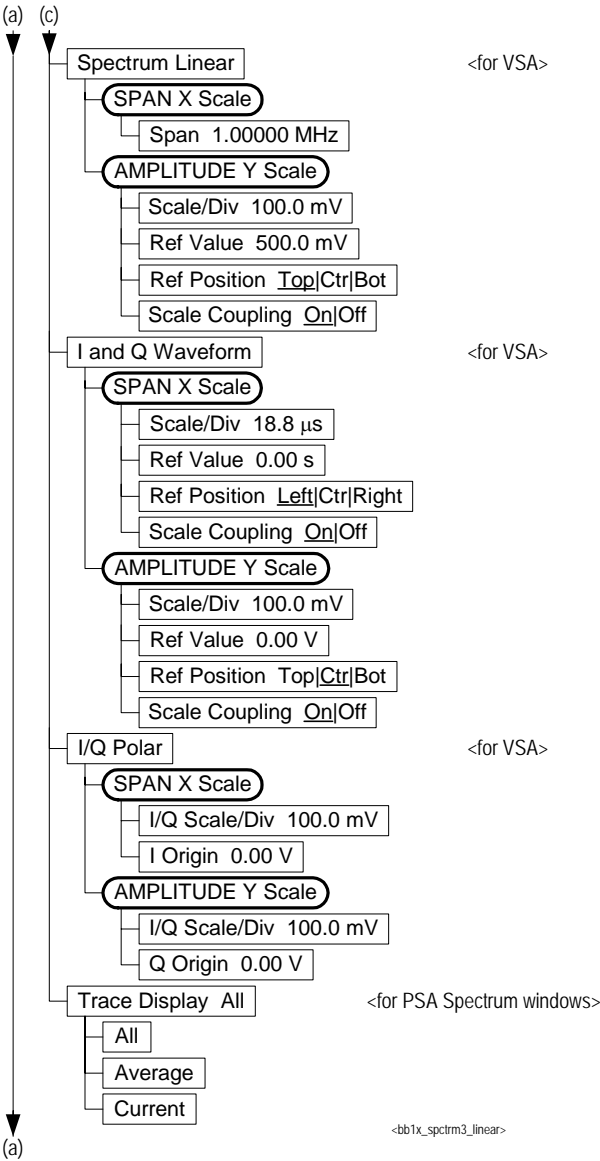


Figure 6-31 Spectrum (Freq Domain) Measurement Key Flow (4 of 4)

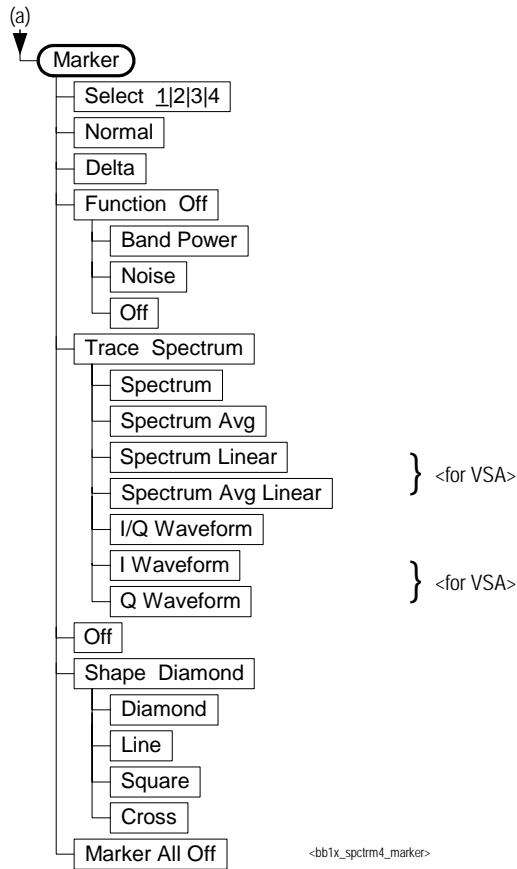
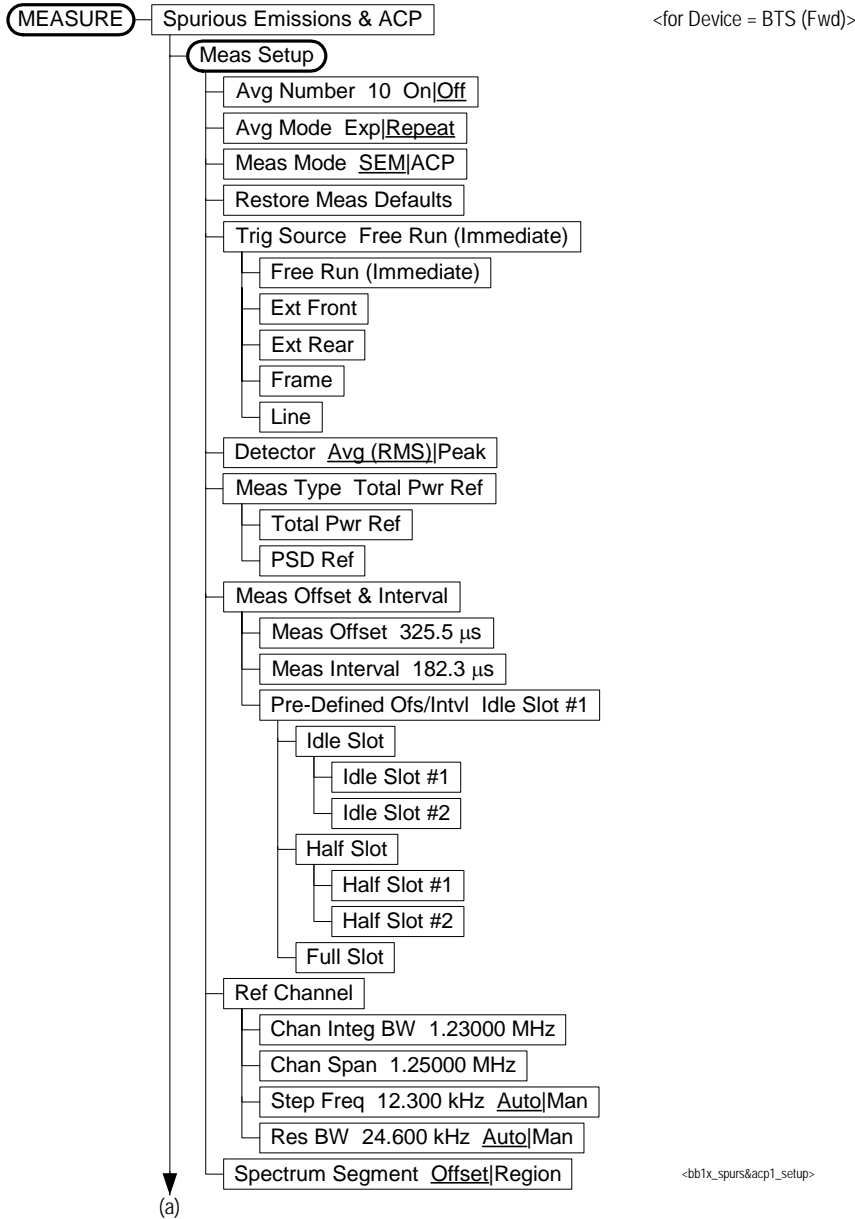


Figure 6-32 Spurious Emissions & ACP Measurement Key Flow (1 of 3)



**Figure 6-33 Spurious Emissions & ACP Measurement Key Flow (2 of 3)**

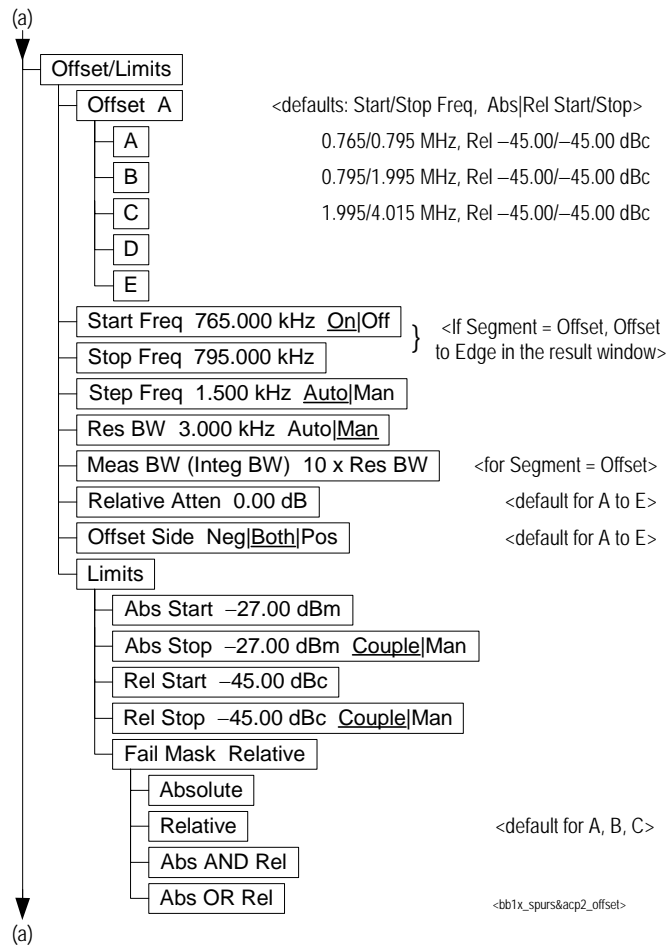
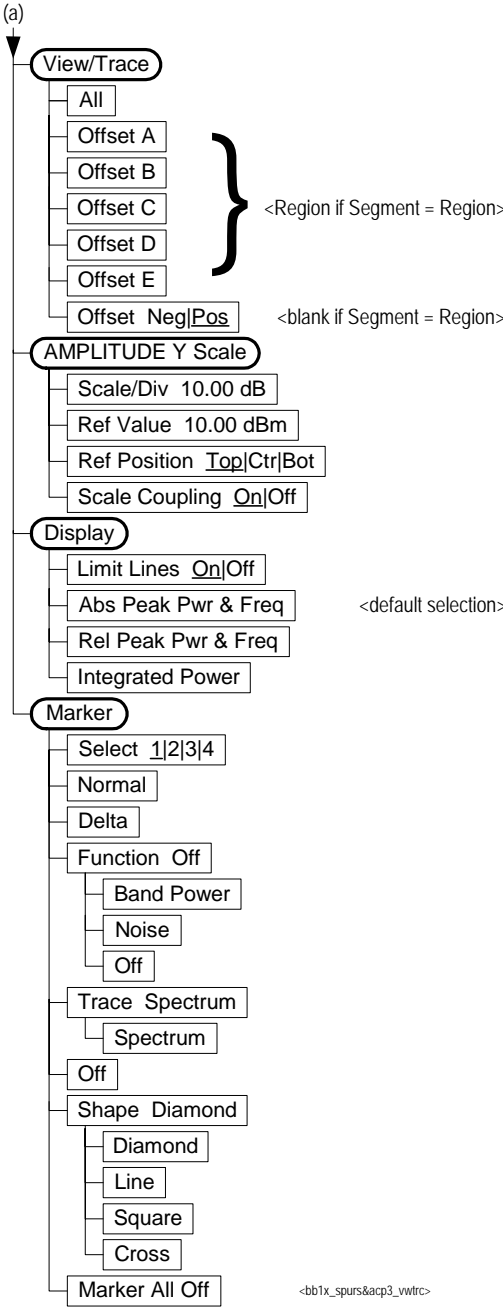


Figure 6-34 Spurious Emissions & ACP Measurement key Flow (3 of 3)



**Figure 6-35 Waveform (Time Domain) Measurement Key Flow (1 of 2)**

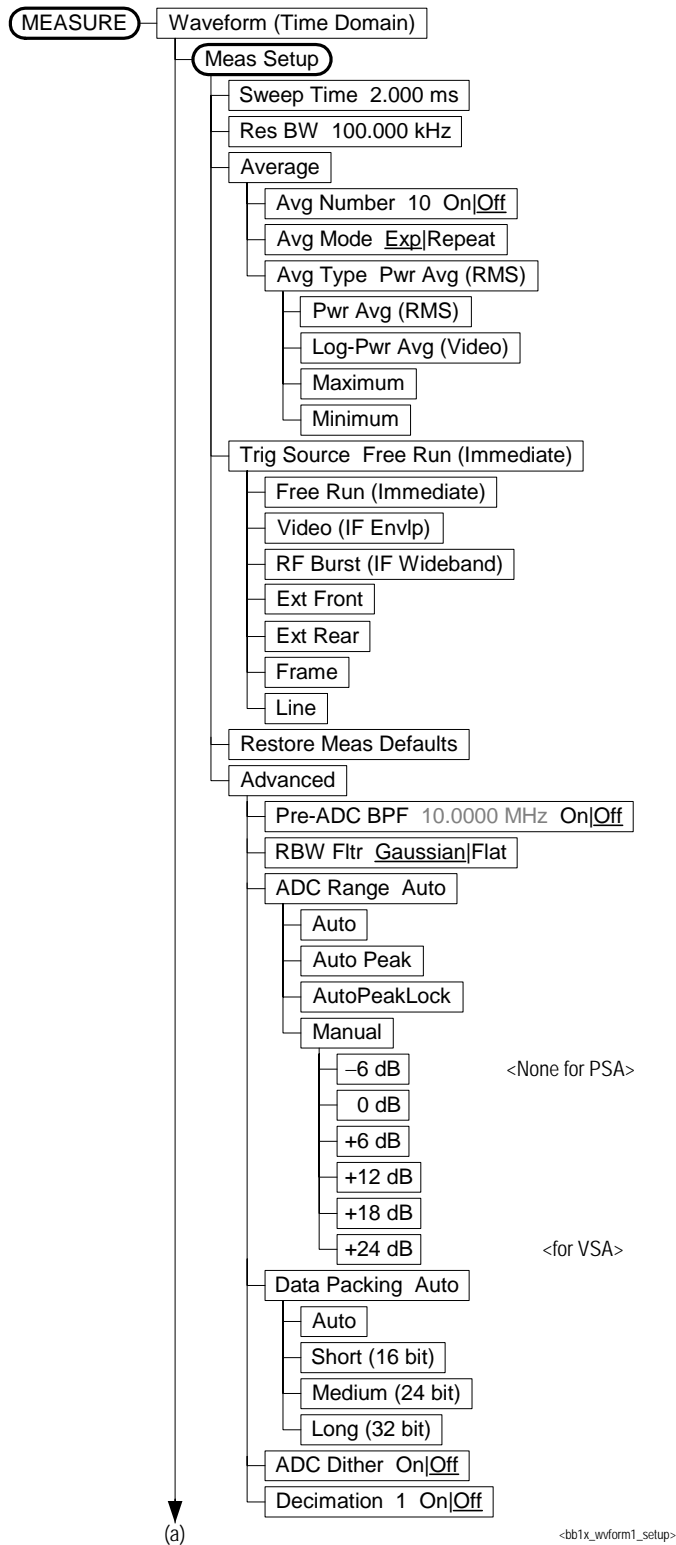
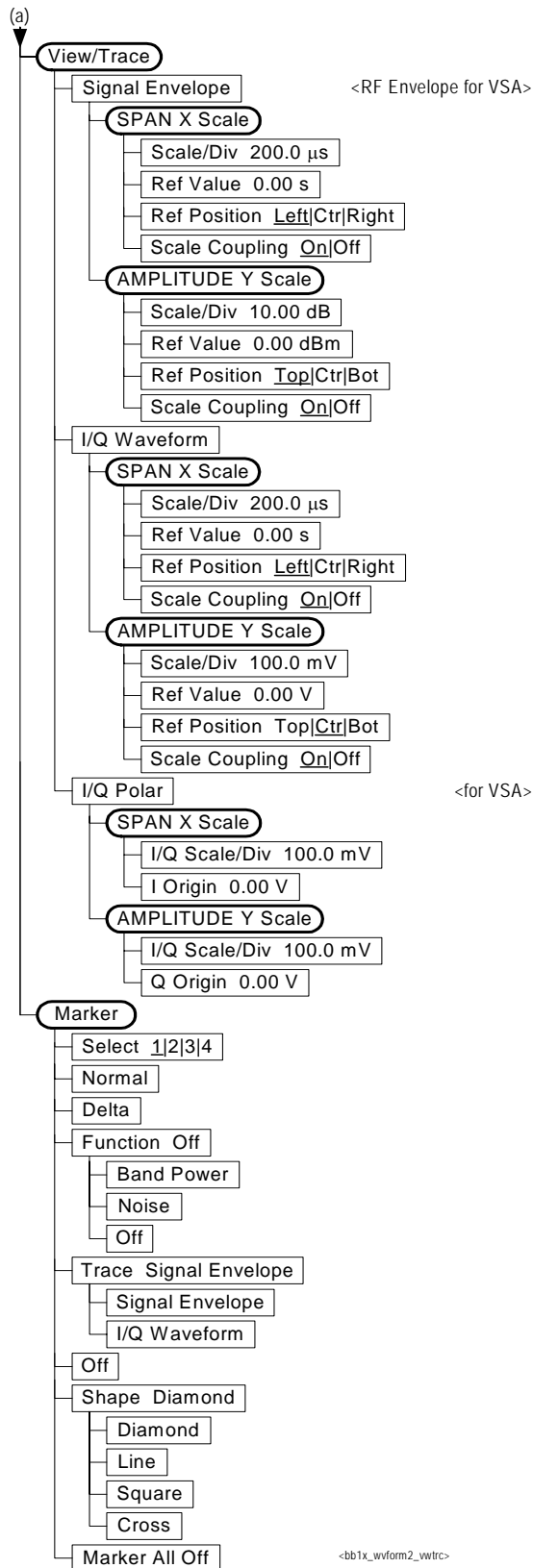


Figure 6-36 Waveform (Time Domain) Measurement Key Flow (2 of 2)



Menu Maps  
1xEV-DO Measurement Key Flow



## Numerics

1xEV-DO  
 mode setup  
 trigger, 154  
 radio, 153  
 terminal modulation accuracy, 339  
 1xEV-DO measurement, 417, 426, 493  
 1xEV-DO system  
 design elements, 587  
 forward link, 586  
 forward link channel TDM structure, 588  
 frame structure, 587  
 high rate packet data, 586  
 high speed packet data communications, 586  
 network rate, 586  
 reverse link coding, 589  
 RF characteristics, 586  
 standard documents, 591  
 what is it?, 586

## A

access network  
 base station, 586  
 access network (BTS), 586  
 access terminal  
 mobile station, 586  
 ACK  
 acknowledge channel, 589  
 ACK channel definition  
 terminal modulation accuracy measurement, 559  
 ACK channel power gain  
 terminal modulation accuracy (rho), 338  
 ACP  
 offset sideband choice, 506  
 testing, 506  
 ACP or spurious emissions  
 marker menu  
 marker selection, 270  
 reference channel integration bandwidth method, 604  
 ACPR  
 testing choices, 506  
 acquisition packing  
 WAVEform, 569  
 active code channel  
 auto detection, 173, 207  
 combined detection, 173, 208  
 use predefined active channel, 173, 208  
 active code domain power  
 tolerance

terminal modulation accuracy (rho), 338  
 active data channel  
 code domain power, 439  
 RHO, 487  
 active license key, 49  
 how to locate, 49  
 active set th (threshold)  
 advanced menu, 165  
 active set threshold  
 CDP, 316  
 modulation accuracy (rho), 330  
 terminal modulation accuracy (rho), 337  
 active set threshold mode  
 modulation accuracy (rho), 331  
 terminal modulation accuracy (rho), 337  
 ADC Corr key, 242, 272  
 ADC Dither key  
 spectrum measurement, 247  
 ADC dithering  
 SPECTrum, 531  
 WAVEform, 569  
 ADC filter  
 WAVEform, 569  
 ADC range  
 code domain power, 439  
 manual control, 235  
 modulation accuracy (rho), 487  
 QPSK EVM, 450  
 SPECTrum, 532  
 terminal code domain  
 measurement, 550  
 terminal modulation accuracy  
 measurement, 560  
 WAVEform, 570  
 ADC Range key  
 spectrum measurement, 246  
 ADC ranging function  
 automatic control, 166, 175, 194, 211, 234, 276  
 automatic control to peak, 166, 175, 194, 211  
 automatic lock to peak, 166, 175, 194, 211, 234  
 automatic peak control, 234, 276  
 automatic peak lock, 276  
 manual control, 166, 175, 194, 211, 276  
 Advanced menu  
 spectrum, 245  
 waveform  
 waveform

advanced menu  
 active set th (threshold), 165  
 active set threshold, 175, 194  
 ADC dither, 276  
 ADC ranging function, 165, 175, 194, 211, 234, 276  
 burst slope detection interval, 228  
 burst slope threshold level, 228  
 chip rate, 165, 175, 194, 210, 234  
 decimation, 276  
 EVM result I/Q offset, 210  
 FFT window, 221  
 integration bandwidth, 188  
 multi channel estimator, 194  
 number of data points, 161  
 overall rho including preamble chips, 194  
 phase compensation, 165  
 pre-ADC bandpass filter, 275  
 resolution bandwidth, 161, 228  
 resolution bandwidth filter, 228, 275  
 rho result I/Q offset, 193  
 sweep time, 161  
 time reference offset, 228  
 trigger source, 161  
 amplitude  
 input range, 467  
 maximizing input signal, 468  
 amplitude Y scale  
 reference position, 163, 189, 204, 205, 219, 223, 231, 270  
 reference value, 163, 189, 204, 205, 219, 222, 231, 270  
 scale coupling, 163, 189, 204, 205, 206, 219, 223, 231, 270  
 scale per division, 163, 189, 203, 204, 205, 219, 222, 231, 269  
 Analog Filter key, 242, 273  
 applications  
 currently available, 372  
 applications, selecting, 372, 374  
 ASCII data format, 368  
 attenuation  
 setting, 466  
 average count  
 intermodulation, 456  
 averaging  
 CHPower, 445, 462, 463  
 modulation accuracy (rho), 488, 489  
 OBW, 462  
 power vs. time, 471, 472  
 QPSK EVM, 451, 452

advanced settings, 275

- SPECTrum, 533, 534
  - traces, 464
  - transmit band spurs, 571
  - WAVEform, 571, 572
  - averaging count
    - spectrum emission mask, 493
  - averaging state
    - intermodulation, 456
    - power vs. time, 471
    - spectrum emission mask, 493
  - averaging termination control
    - intermodulation, 456
  - averaging type
    - log power averaging (video), 226
    - maximum voltage averaging, 226
    - minimum voltage averaging, 226
    - rms power averaging, 226
    - voltage averaging, 226
- B**
- bandwidth
    - occupied bandwidth, 463
    - power vs. time, 473
    - PVTime, 474, 475
    - SPECTrum, 537, 538
    - spectrum emission mask, 494
    - WAVEform, 573, 574
  - base frequencies delta
    - intermodulation, 458
  - base frequency auto search
    - intermodulation, 458
  - base frequency selection
    - delta frequency (f1-f0), 188
    - lower frequency (f0), 188
    - upper frequency (f1), 188
  - base lower frequency
    - intermodulation, 459
  - base station testing, 485
  - base transmit station
    - loss correction, 449
  - base upper frequency
    - intermodulation, 459
  - basic mode, 141
  - binary data order, 368
  - Block Size key, 272
  - burst trigger
    - level, 582
  - byte order of data, 368
- C**
- captured data block size (wideband IF), 272
  - captured data sample rate (wideband IF), 272
  - carrier selection, 485
  - CCDF measurement, 395
  - CDMA measurement, 386, 439, 445, 487
  - cdma2000
    - averaging, 451, 452
    - offset frequencies, 498, 514, 515, 526
    - offset frequencies auto mode, 499, 500, 516
    - spectrum emission mask
      - measurement, 506, 508, 509, 511, 513, 520, 521, 523, 524, 525, 526
    - trigger source, 454, 492, 529
  - cdma2000 measurement, 388, 391, 394, 395, 401, 408, 450, 456, 462, 469, 493
  - cdmaOne
    - trigger source, 492
  - cdmaOne measurement, 380, 401
  - CDP
    - active set threshold, 316
    - computation type, 320
    - data bit format threshold, 317
    - data channel type, 320
    - measurement channel type, 317
    - sweep offset, 318
    - sweep time, 319
    - Walsh code number, 320
    - Walsh code order, 321
  - CDPower
    - chip rate, 441
    - data capture time, 441
    - Phase compensation by pilot, 442
    - selecting spectrum type, 443
    - trigger source, 444
    - view of data, 353
  - changing
    - instrument settings, 439
  - channel power
    - advanced menu, 592
    - amplitude Y scale, 163
    - changing display, 163
    - channel bandwidth, 592
    - power spectral density, 592
    - time record length, 592
  - channel power measurement
    - See also CHPower
  - channel power measurement, 386, 445
  - channel type
    - data channel, 164
    - medium access control channel, 164
    - pilot channel, 164
  - chip power graph
    - amplitude Y scale
      - reference position, 171
      - reference value, 170
      - scale coupling, 171
      - scale per division, 170
    - span X scale
      - reference value, 170
      - scale coupling, 170
      - scale per division, 170
  - chip rate
    - CDPower, 441
    - modulation accuracy (rho), 489
    - QPSK EVM, 452
  - Choose Option key, 48
  - CHPower
    - number of points, 446
    - sweep time, 447
    - trigger source, 448
  - code domain
    - display, 181
      - chip dots, 181
    - I/Q gain imbalance, 593
    - I/Q modulation impairments, 593
    - I/Q polar and power graph, 594
    - I/Q quadrature error, 593
    - in-channel characteristics, 593
  - marker function, 185
    - all markers off, 186
    - delta reading, 185
    - despread marker position, 186
    - marker measurement
      - function, 185
    - marker selection, 185
    - normal reading, 185
    - off, 186
    - shape selection, 186
    - trace to be marked, 186
  - marker menu, 171
  - measure setup
    - advanced menu, 175
    - measurement interval, 173
    - measurement offset, 173
    - Walsh code number, 172
  - next window, 177
  - pilot channel, 593
  - power composite view, 593
  - power graph & metrics, 593
  - spread channels, 593
  - traffic channel, 593
  - view/trace
    - code domain with quad view, 180
    - demodulated bit stream view, 181
    - demodulated bits, 182

- I/Q error graphs, 184, 203, 204, 205, 218, 219, 238, 239
  - IQ error (quad view), 178
    - power graph & metrics, 177
    - width of channel, 593
    - zoom, 177
  - code domain error limit
    - terminal modulation accuracy (rho), 338
  - Code Domain measurement
    - Code Domain Power Graph, 74
  - code domain measurement
    - display menu, 169
    - multi channel estimator, 211
    - print setup, 185
    - timing estimation, 211
    - using print function, 185
    - view/trace menu, 167
  - code domain power
    - active data channel, 439
    - ADC range, 439
  - code domain power graph
    - amplitude Y scale, 170, 183
    - reference value, 170, 183
    - scale per division, 170, 183
  - display, 181
    - code order, 181
    - consolidated marker, 182
    - span X scale, 169
    - reference value, 169, 170
    - scale per division, 169
  - code domain power measurement, 380, 439
    - See also CDPower
  - code, programming
    - compatibility across PSA modes, 291, 293
    - compatibility, PSA series versus VSA, 294
  - commands
    - compatibility across PSA modes, 291, 293
    - CONFigure, 378
    - FETCh, 378
    - MEASure, 377
    - PSA series versus VSA compatibility, 294
    - READ, 379
  - compatibility, programming
    - across PSA modes, 291
    - PSA series versus VSA, 294
  - CONFigure command use, 375
  - CONFigure commands, 378
  - continuous vs. single
    - measurement mode, 370
  - control measurement commands, 370
  - correction
    - base transmit station loss, 449
    - mobile station loss, 449
  - corrections
    - wideband ADC corrections, 242, 272
  - current measurement, 352
  - curve fit the data, 296, 303
- D**
- data
    - querying, 296, 303
  - data block size, 272
  - data capture time
    - CDPower, 441
  - data channel power gain
    - terminal modulation accuracy (rho), 339
  - data channel type
    - 16QAM, 165
    - 8PSK, 164
    - QPSK, 164
  - data decimation, 538
    - WAVEform, 574, 575
  - Data entry keypad, 148
  - data format, 368
  - data from measurements, 375
  - Data Packing
    - spectrum measurement, 247, 276
  - data sample rate, 272
  - Decimation
    - spectrum measurement, 247
  - decimation
    - SPEctrum, 538
  - decimation of data
    - WAVEform, 574, 575
  - default states, 58
  - default values, setting remotely, 378
  - deleting an
    - application/personality, 43
  - delta markers, 310
  - demodulated bits
    - display, 182
    - print setup
      - print demod bits, 182
  - demodulated bits window
    - display
      - first page, 182
      - last page, 182
      - next page, 182
      - previous page, 182
      - scroll down, 182
      - scroll up, 182
  - design elements
    - best serving cell, 587
    - data rate request, 587
    - efficient data delivery, 587
    - full power, 587
    - rate control, 587
    - time division multiplexed, 587
  - detector
    - peak or average power, 258
  - display
    - +45 degrees rotation, 202, 218
    - background full vector traces, 218
    - chip interval, 218
    - chip offset, 217
    - code order
      - bit reversed, 182
      - Hadamard, 181
    - PVT limits, 354
    - spectrum window, 356, 357, 364, 365
    - tiling, 353
    - trace, 359
    - window tile, 353
    - zoom, 354
  - display code domain data, 353
  - display commands, 353
  - display key
    - burst search threshold line, 230
    - limit mask, 230
  - display menu
    - absolute peak power levels & frequencies, 269
    - chip descrambled, 202
    - chip dots, 237
    - chip offset, 202
    - data channel period, 202
    - full vector (background), 202
    - Gaussian line display, 224
    - I/Q chips, 202
    - I/Q points, 237
    - IM products lines, 190
    - integrated power levels, 269
    - limit lines, 269
    - MAC channel period, 202
    - phase reference for I/Q graph, 203
    - pilot channel period, 202
    - reference trace display, 224
    - relative peak power levels & frequencies, 269
    - store reference trace, 224
    - vector and/or constellation selection, 202
  - display PVT data, 354, 355
  - display rho data, 355
  - dithering of ADC

- WAVEform, 569
- dithering the ADC, 531
- DRC
  - data request channel, 589
- DRC channel power gain
  - terminal modulation accuracy (rho), 339
- E**
- EVM graph
  - amplitude Y scale, 219
- EVM or magnitude error graph
  - amplitude Y scale, 204
  - reference position, 238
  - reference value, 238
  - scale per division, 238
- external trigger
  - delay, 578
  - level, 578
  - slope, 579
- F**
- fail mask condition
  - absolute limit, 262, 264
  - absolute limit AND relative limit, 262, 265
  - absolute limit OR relative limit, 262, 265
  - relative limit, 262, 265
- FETCh command use, 375
- FETCh commands, 378
- FFT
  - SPECTrum, 539, 540, 541
- FFT bandwidth, SPECTrum, 535, 536, 537
- FFT Length key, 243, 246
- FFT Size menu, 242, 246
- FFT window
  - Blackman filter, 222
  - Blackman-Harris filter, 222
  - flat top filter, 221
  - Gaussian filter with alpha 3.5, 222
  - Hamming filter, 222
  - Kaiser-Bessel 110 dB filter, 222
  - Kaiser-Bessel 90 dB filter, 222
  - occupied bandwidth, 464
  - uniform filter, 221
- FFT Window key., 242, 245
- filter
  - gain setup (wideband), 241, 272
  - setup (wideband), 241, 272
  - type (wideband), 272
- Filter Alpha key, 241, 272
- Filter BW key, 241, 272
- Filter Type key, 241, 272
- Flat Top key, 241, 272
- format, data, 368
- forward link channel TDM
  - structure
    - medium access control, 588
- forwardlink channel TDM
  - structure
    - pilot channel, 589
    - preamble, 588
    - traffic channel, 588
- frame trigger adjustment, 579, 580
- frame trigger period, 579
- frame trigger sync mode, 580
- frequency
  - carrier setting, 485
- frequency band limits
  - OBW, 322
- frequency channel, 149
  - center frequency, 149
  - center frequency step, 149
- FREQUENCY Channel key, 148
- frequency error limit test
  - RHO, 332
- frequency span
  - CHPower, 446
  - SPECTrum, 542
  - spectrum emission mask, 496
- FT window
  - Hanning filter, 222
- G**
- Gaussian key, 241, 272
- GSM measurement, 471
- H**
- half slot
  - #1 or #2, 258
- I**
- I and Q waveform view
  - I or Q waveform window, 255
- I or Q waveform window
  - amplitude Y scale, 255
  - reference position, 256
  - reference value, 256
  - scale coupling, 256
  - scale per division, 255
  - span X scale
    - reference position, 254, 283
    - reference value, 254, 283
    - scale coupling, 254, 283
    - scale per division, 254, 282
- I origin
  - I/Q polar window, 283, 286
- I Origin key, 255, 256
- I waveform window
  - amplitude Y scale, 285
  - reference position, 286
  - reference value, 285
  - scale coupling, 286
  - scale per division, 285
- iDEN
  - trigger source, 465
- iDEN measurement, 394, 462
- idle slot
  - #1 or #2, 258
- IF BW key, 272
- IF filter
  - gain setup, 241, 272
  - setup, 272
  - type, 272
- IF Flat Corr key, 242, 272
- IF Flatness
  - advanced spectrum feature, 247
- amplitude Y scale, 285
  - reference position, 286
  - scale coupling, 286
  - scale per division, 285
- I/Q data output, 141
- I/Q data results, 414, 436
- I/Q error graphs
  - EVM or magnitude error graph
    - amplitude Y scale
      - scale coupling, 239
  - span X scale, 184
    - reference position, 184, 238
    - reference value, 184, 238
    - scale coupling, 184, 238
    - scale per division, 184, 238
- I/Q Polar view
  - waveform measurement, 283, 286
- I/Q polar view
  - I/Q polar window, 255, 256, 283, 286
- I/Q polar window
  - amplitude Y scale, 256
  - I/Q scale per division, 255, 256
  - Q Origin, 255, 256
  - I origin, 283, 286
  - I/Q scale per division, 283, 286
  - Q origin, 283, 286
  - span X scale, 255, 256
    - I Origin, 255, 256
- I/Q scale per division
  - I/Q polar window, 283, 286
- I/Q Scale/Div key, 255, 256
- I/Q waveform graph
  - amplitude Y scale, 205
- I/Q waveform view
  - I/Q waveform window, 285
- I/Q waveform window, 282, 283
  - amplitude Y scale, 285
  - reference position, 286
  - reference value, 285
  - scale coupling, 286
  - scale per division, 285

- IF path filter
    - alpha, 241, 272
    - bandwidth, 241, 272
    - setup, 241
    - type, 241
  - IF Path key, 245, 275
  - IF setup, 241, 272
  - IF trigger delay, 581
  - IF trigger level, 581
  - IF trigger slope, 582
  - initial signal connection, 58
  - initiate measurement, 370, 371
  - input
    - input attenuator, 158
    - max total power, 158
  - input attenuation, 466
  - input port selection, 455
  - input power
    - maximum, 468
    - range, 467
  - Input/Output menu, 157
    - 50 MHz reference, 157
    - external attenuator, 158
      - attenuation for BTS tests, 158
      - attenuation for MS tests, 158
    - IF align, 157
    - input attenuator, 158
    - input port, 157
      - 50 MHz reference, 157
      - rf, 157
    - Internal RF Preamplifier (PSA only), 158
    - maximum total power, 157
    - RF input range, 157
  - Install Now key, 48
  - Installing and Obtaining a license key, 47
  - installing measurement personalities, 43
  - instrument configuration, 372
  - integration bandwidth
    - intermodulation, 457
  - intermodulation
    - average count, 456
    - averaging state, 456
    - averaging termination control, 456
    - base frequencies delta, 458
    - base frequency auto search, 458
    - base lower frequency, 459
    - base lower signal, 87, 110
    - base upper frequency, 459
    - integration bandwidth, 457
    - intermodulation graph, 87, 110
    - measurement mode, 460
    - measurement reference, 460
    - resolution bandwidth, 457
    - resolution bandwidth state, 458
    - span, 460
    - transmit intermodulation products, 595
    - two-tone intermodulation products, 595
    - using markers, 190
    - view/trace menu, 189
  - intermodulation measurement, 391, 456
    - See also IM
  - internal reference selection, 455
  - Internal RF Preamplifier (PSA Only), 158
  - IQ port selection, 455
- ## K
- key flow diagram
    - acpr, 610
    - channel power, 610
    - code domain, 610
    - intermodulation, 610
    - mode setup / frequency channel, 610
    - modulation accuracy (composite EVM), 610
    - occupied bandwidth, 610
    - power statistic CCDF, 610
    - QPSK EVM, 610
    - spectrum (frequency domain), 610
    - spectrum emission mask, 610
    - waveform (time domain), 610
- ## L
- length
    - QPSK EVM, 453
  - Length Ctrl key, 242, 246
  - Length key, 242, 246
  - license key
    - obtaining and installing, 47
  - limit line testing, 296
  - limit testing
    - cdmaOne, 331, 332
    - EVM, 331, 332
    - OBW, 322
    - RHO, 331, 332
  - limits
    - absolute start level, 264
    - ACK channel gain, 210
    - active channel code domain
      - power tolerance, 209
    - composite peak EVM, 193, 209
    - composite rho, 193, 209
    - composite rms EVM, 193, 209
    - data channel gain, 210
    - data rate control channel gain, 210
    - fail mask condition, 264
    - frequency error, 193, 209
    - inactive channel code domain
      - power, 209
    - maximum MAC channel
      - inactive power, 193
    - minimum data channel active
      - power, 193
    - peak code domain error, 209
    - phase error, 193, 209
    - pilot offset, 193, 209
    - relative start level, 264
    - relative stop level, 264
    - reverse rate indicator vs pilot
      - power ratio tolerance, 209
    - timing error, 193, 209
  - limits absolute stop level, 264
  - linear envelope view
    - linear envelope window, 284
    - phase window, 285
  - linear envelope window, 282, 283
    - amplitude Y scale, 284
    - reference position, 284
    - reference value, 284
    - scale coupling, 285
    - scale per division, 284
  - linear spectrum window
    - amplitude Y scale
      - reference position, 255
      - reference value, 255
      - scale coupling, 255
      - scale per division, 255
    - span, 254
  - loading an
    - application/personality, 43
  - lower mask
    - level and on/off, 227
- ## M
- ### MAC
- medium access control, 588
- magnitude error graph
  - amplitude Y scale, 219- major functional keys, 55, 146
- making measurements, 375
- marker menu
  - delta reading, 171, 225
  - despread marker position, 171
  - erase a marker, 171, 225
  - erase all markers, 171, 225
  - function, 225
  - marker function, 171
  - marker selection, 171
  - normal reading, 171, 225
  - select 1 to 4, 224

- shape selection, 171, 225
- trace selection, 171, 225
- markers, 305
  - assigning them to traces, 311
  - maximum, 309
  - minimum, 309
  - off, 310
  - trace assignment, 315
  - turn off, 308
  - type, 310
  - valid measurement, 305
  - value, 316
  - value of, 308
  - x-axis location, 315
  - y-axis, 316
- masks
  - power vs. time, 475, 476, 477, 478, 479, 480, 482, 483
- maximum value of trace data, 296, 303
- mean value of trace data, 296, 303
- meas setup
  - sync start slot, 174, 209
- Meas Setup key, 148
- Meas Time key, 271
- MEASure command use, 375
- MEASure commands, 377
- MEASURE key, 148
- measure setup
  - active code channel, 173, 207
  - advanced menu, 210
  - capture interval, 175
  - I long code mask, 173, 210
  - I/Q branch signals, 172
  - limits, 209
  - measure type, 172
  - predefined active channel, 173, 208
  - Q long code mask, 173, 210
  - restore measurement defaults, 161, 245, 275
  - spectrum, 175, 210
- measure setup Walsh code length, 172
- measure type
  - absolute power, 172
  - relative power, 172
- measurement
  - ACP or spurious emissions mask, 257, 604
  - channel power, 160, 445, 592
  - code domain, 163, 172, 593
  - code domain power, 439
  - intermodulation, 456
  - intermodulation products, 187, 595
  - transmit intermodulation, 595
- markers, 305
- modulation accuracy (composite rho), 191, 207, 597
  - correlated power, 597
  - modulation quality, 597
  - rho, 597
- modulation accuracy (rho), 487
- occupied bandwidth, 220, 599
- occupied BW, 462
- power statistics CCDF, 223, 600
  - Gaussian distribution curve, 600
- power statistics CCDF measurement, 469
- power vs. time, 471
- QPSK error vector magnitude, 450
- QPSK EVM, 232, 602
- query current, 352
- spectrum (frequency domain), 531
- spectrum emission mask, 493
- spurious emissions and ACP, 493
- waveform (time domain), 569
- measurement channel type
  - CDP, 317
  - RHO, 334
- measurement control
  - measure, 153
  - pause, 153
  - restart, 152
- measurement data type
  - RHO, 335
- measurement key flow, 610
- measurement mode
  - ACP, 258, 268
  - automatic search mode, 187
  - intermodulation, 460
  - spurious emissions mask, 258
  - transmit IM mode, 187
  - two-tone mode, 187
- measurement modes
  - currently available, 372
  - selecting, 372, 374
- measurement offset
  - QPSK EVM, 453
- measurement offset and interval
  - measurement interval, 233, 258
  - measurement offset, 233, 258
  - pre-defined offset and interval, 258
  - predefined offset and interval, 233
- measurement reference
  - intermodulation, 460
- measurement reference type
  - mean power spectral density reference, 258
  - total power reference, 258
- measurement selection
  - channel power, 149
  - code domain, 150
  - intermodulation products, 149
  - modulation accuracy (composite rho), 151
  - occupied bandwidth, 150
  - power statistic CCDF, 152
  - power versus time, 150
  - QPSK EVM, 151
  - spectrum (frequency domain), 152
  - spurious emissions and adjacent channel power (ACP), 150
  - waveform (time domain), 152
- measurement setup
  - active data channel, 165, 192
  - advanced menu, 161, 165, 188, 193, 221, 228, 234
  - automatic search for base frequency signal, 188
  - averaging mode, 160, 187, 191, 207, 221, 232, 243, 257, 273
  - exponential, 160, 187, 191, 207, 221, 233, 243, 257, 273
  - normal, 187, 191, 207, 221, 232, 257
  - repeat, 187, 192, 207, 221, 233, 257
  - averaging number, 160, 187, 191, 207, 221, 226, 232, 243, 257, 273
  - averaging type, 226, 243, 273
  - log power average (video), 244, 274
  - maximum voltage average, 244, 274
  - minimum voltage average, 244, 274
  - power average (rms), 243, 274
  - voltage average, 244, 274
  - base frequency selection, 188
  - burst search threshold, 228
  - capture interval, 165
  - channel power span, 160
  - channel type, 164, 192
  - data channel type, 164, 192
  - detector, 258
  - frequency span, 188, 221
  - integration bandwidth, 160
  - limit frequency value, 221
  - limit test, 221
  - limits, 193

- measurement bandwidth, 223
- measurement interval, 164, 223
- measurement mode, 187, 258
- measurement offset, 164
- measurement offset and interval, 233, 258
- measurement reference type, 258
- measurement type, 163
- number of counts, 223
- offsets and limits, 260
- PN offset, 164, 193
- power reference, 227
- preamble length, 165, 192
- reference channel, 259
- reference signal, 187
- region and limits, 227
- resolution bandwidth, 188, 221
- slot type, 226
- spectrum, 165, 193
- spectrum segment, 260
- time averaging number, 244, 274
- time reference, 227
- trigger source, 226, 258
- Walsh code number, 164
- measurement type
  - absolute or relative, 163
- measurements
  - CCDF, 395
  - channel power, 386
  - code domain power, 380
  - CONF/FETC/MEAS/READ
    - commands, 375
  - control of, 370
  - getting results, 375
  - intermodulation, 391
  - modulation accuracy, 401
  - modulation accuracy, terminal, 426
  - occupied BW, 394
  - power stat, 395
  - power versus time, 225, 601
  - power vs. time, 397
  - QPSK error vector magnitude, 388
  - setting default values remotely, 378
  - single/continuous, 370
  - spectrum (frequency domain), 414
  - spectrum emission mask, 408
  - terminal code domain power, 417
  - waveform (time domain), 436
- measuring I/Q data, 414, 436
- measuring in the time domain, 140
- medium access control
  - reverse activity, 588
  - reverse power control, 588
- memory
  - security erase, 50
- Min Pts in RBW key, 242, 246
- minimum value of trace data, 296, 303
- missing options, 43
- mobile station
  - loss correction, 449
- mobile station testing, 485
- MODE key, 148
- Mode Setup key, 148
- mode setup menu, 156
- Physical layer Subtype, 156
- RF Carrier, 156
- modulation accuracy (rho)
  - active set threshold, 330
  - active set threshold mode, 331
  - phase error limit, 333
  - pilot time offset limit, 333
  - rho result I/Q offset, 331
  - time offset limit, 334
- modulation accuracy (rho) (BTS)
  - peak EVM limit, 333
  - rho limit, 334
  - RMS EVM limit, 334
- modulation accuracy (rho)
  - measurement, 487
  - See also RHO
- modulation accuracy
  - measurement, 401
- multi carrier estimator
  - modulation accuracy (rho), 490
- multi channel estimator
  - code domain measurement, 211
- N**
- normal marker, 310
- O**
- OBW
  - limit testing, 322
  - trigger source, 465
- OBW averaging, 462
- occupied bandwidth
  - 99.0% bandwidth, 599
  - FFT window, 464
  - spectrum shape, 599
  - transmitter operation, 599
  - view/trace menu, 222
- occupied BW measurement, 394, 462
- See also OBW
- offset frequencies
  - spectrum emission mask, 498, 514, 515, 526
- offset frequencies auto mode
  - spectrum emission mask, 499, 500, 516
- offsets & limits
  - offset side, 262
  - relative attenuation, 261
- offsets and limits
  - limits, 262
  - absolute start level, 262
  - absolute stop level, 262
  - fail mask condition, 262
  - relative start level, 262
  - relative stop level, 262
- measurement bandwidth, 261
- offset, 260
- resolution bandwidth, 261
- start frequency, 260
- step frequency, 261
- stop frequency, 261
- Option 122 wideband selection, 245, 275
- options
  - loading/deleting, 43
- options not in instrument
  - memory, 43
- P**
- packing
  - SPECTrum, 531
- pass/fail test, 296
- PDC
  - trigger source, 465
- PDC measurement, 394, 462
- peak EVM limit
  - cdma2000 (BTS), 333
  - modulation accuracy (rho) (BTS), 333
  - terminal modulation accuracy (rho), 341
  - W-CDMA (3GPP) (BTS), 333
- personalities
  - currently available, 372
  - selecting, 372, 374
- personality options not in instrument, 43
- Phase compensation by pilot
  - CDPower, 442
- phase error
  - amplitude Y scale
    - reference position, 185
    - reference value, 185
    - scale coupling, 185
    - scale per division, 184
- phase error graph

- amplitude Y scale
    - reference position, 239
    - reference value, 239
    - scale coupling, 239
    - scale per division, 239
  - phase error limit
    - cdma2000, 333
    - modulation accuracy (rho), 333
  - phase inversion, 443
  - phase window, 282, 283
    - amplitude Y scale, 285
    - reference position, 285
    - reference value, 285
    - scale per division, 285
  - pilot time offset limit
    - modulation accuracy (rho), 333
    - terminal modulation accuracy (rho), 341
  - PN offset
    - CDPower, 442
    - modulation accuracy (rho), 490
  - points/measurement
    - CHPower, 446
  - power on/off switch, 148
  - power reference
    - region A through region E, 227
  - power statistic CCDF
    - cdma2000, 324
    - store reference, 324
    - W-CDMA (3GPP), 324
  - power statistics CCDF
    - measurement, 469
    - See also PSTat
  - power versus time
    - amplitude Y scale, 231
    - changing the display, 230
    - changing the view, 230
      - view/trace selection, 230
    - display key, 230
    - marker key, 232
    - measurements, 225, 601
    - span X scale, 231
  - power vs. time
    - averaging state, 471
  - power vs. time - averaging mode, 472
  - power vs. time - averaging type, 472
  - power vs. time - limit line mask
    - display, 475
  - power vs. time - lower mask
    - relative amplitude levels, 478
  - power vs. time - number of bursts
    - averaged, 471
  - power vs. time - resolution
    - bandwidth, 473
  - power vs. time - trigger source, 484
  - power vs. time - upper mask
    - absolute amplitude levels, 479, 480
  - power vs. time - upper mask
    - relative amplitude levels, 476, 477, 479, 480, 482, 483
  - power vs. time measurement, 397, 471
    - See also PVTtime
  - pre-ADC bandpass filter
    - SPECTrum, 536
  - Pre-ADC BPF key
    - spectrum measurement, 245
  - preamble auto detection
    - CDPower, 443
    - RHO, 491
  - preamble length
    - CDPower, 443
    - RHO, 490
  - Preamplifier
    - Setting the internal preamplifier, 158
  - pre-amplifier
    - attenuator, 466
    - on/off, 466
  - predefined active channel
    - acknowledge channel at W8(4) I, 174, 208
    - data channel at B4(W4(2) Q), 174, 209
    - data channel at Q2(W4(2)), 174, 209
    - data channel at Q4(W4(2)), 174, 209
    - data channel at Q4Q2(W4(2), W2(1)), 174, 209
    - data channel at W4(2) Q, 174, 208, 209
    - data channel Off, 174, 209
    - data rate control channel at W16(8) Q, 174, 208
    - pilot channel at W16(0) I, 174, 208
  - pre-FFT bandwidth, SPECTrum, 535, 536, 537
  - Pre-FFT BW key, 245
  - Pre-FFT Fltr key, 245
  - preset, 58
    - factory defaults, 58
  - preset measurement offset and interval
    - full slot, 259
    - half slot, 258
    - idle slot, 258
    - idle slot #1 or #2, 233
    - MAC channel #1, #2, #3, #4, 233
    - pilot channel #1 or #2, 233
  - print setup
    - print demodulated bits data, 185
  - procedure
    - using the waveform measurement, 140
  - programming
    - compatibility among PSA modes, 291, 293
    - compatibility, PSA series versus VSA, 294
  - PSA series versus VSA
    - (programming compatibility), 294
  - PVT
    - view of data, 354, 355
  - PVT limits display, 354
  - PVT measurement setup
    - averaging mode, 226
  - PVTtime
    - bandwidth, 474, 475
- ## Q
- Q origin
    - I/Q Polar window, 283, 286
    - I/Q polar window, 283, 286
  - Q Origin key, 255, 256
  - Q waveform window
    - amplitude Y scale, 285
    - reference position, 286
    - reference value, 285
    - scale coupling, 286
    - scale per division, 285
  - QPSK error vector magnitude
    - measurement, 388, 450
  - QPSK error vector measurement
    - See also EVMQpsk
  - QPSK EVM
    - ADC range, 450
    - averaging, 451, 452
    - chip rate, 452
    - length, 453
    - measurement offset, 453
    - phase and frequency errors, 602
    - quadrature phase shift keying modulation, 602
    - RF carrier mode, 453
    - trigger source, 454
    - view/trace menu, 235, 237, 239
  - QPSK EVM phase trajectory, 602
  - query data, 296, 303



## R

### RA

reverse activity, 588

### radio

#### device

BTS, 153

BTS & MS, 153

BTS (forward link), 153

MS (reverse link), 153

Raised Cosine Key, 241, 272

READ command use, 375

READ commands, 379

real number data format, 368

rear panel external trigger

delay, 578

slope, 579

reference channel

channel integration bandwidth, 259

channel span, 259

resolution bandwidth, 259

step frequency, 259

reference channel resolution

bandwidth

spectrum emission mask, 495

reference channel resolution

bandwidth auto mode

spectrum emission mask, 495

reference channel step frequency

spectrum emission mask, 497

reference channel step frequency

auto mode list

spectrum emission mask, 498

reference signal

automatic setting, 187

average signal, 188

lower frequency signal, 188

upper frequency signal, 188

reference, selecting internal, 455

region and limits

interval, 227

lower mask, 227

offset start, 227

offset stop, 227

power reference on/off, 227

region, 227

upper mask, 227

regions and limits

limits, 264

region, 263

relative attenuation, 264

resolution bandwidth, 264

start frequency, 263

step frequency, 264

stop frequency, 263

Res BW key

spectrum measurement, 241

waveform measurement, 271

resolution bandwidth

automatic mode, 188

intermodulation, 457

manual mode, 188

resolution bandwidth state

intermodulation, 458

Restart key, 148

restart measurement, 371

results, waveform measurement, 606

return data, 296, 303

Return key, 148

Reverse Link Code Domain

measurement

CDP & CDE view, 79

Code Domain (quad view), 81

Symbol (chip) power view, 81

Code Domain Power Graph

Bit Reverse display, 76

I/Q Combined (IQC) display, 77

marker display, 75

Demod Bits view, 82

Demod Bits Zoom view, 83

I/Q Error (quad view), 80

reverse link coding

acknowledge channel, 589

data request channel, 589

reverse link scrambling, 590

reverse rate indication, 589

Reverse Link Modulation

Accuracy measurement

Measured Polar Vector Graph, 98

RF carrier mode

QPSK EVM, 453

RF characteristics

spread rate, 586

RF INPUT port, 148

RF input port gain setting when

pre-amplifier is on, 466

RF input port power gain, 466

RF input, selection, 455

RHO

active data channel, 487

frequency error limit test, 332, 339

limit testing, 331, 332

measurement channel type, 334

measurement data type, 335

spectrum type, 491

view of data, 355

rho limit

cdma2000 (BTS), 334

modulation accuracy (rho)

(BTS), 334

terminal modulation accuracy (rho), 341

W-CDMA (3GPP) (BTS), 334

rho overall preamble included

RHO, 491

rho result I/Q offset

modulation accuracy (rho), 331

terminal modulation accuracy

(rho), 337

RMS EVM limit

cdma2000 (BTS), 334

modulation accuracy (rho)

(BTS), 334

terminal modulation accuracy

(rho), 342

W-CDMA (3GPP) (BTS), 334

RMS of trace data, 296, 303

Root Nyquist key, 241, 272

RPC

reverse power control, 588

RRC (root raised cosine) key, 241, 272

RRI

reverse rate indication, 589

RRI limit

1xEV-DO, 342

terminal modulation accuracy

(rho), 342

## S

Sample Rate key, 272

sampling trace data, 296, 303

security memory erase procedure,

information and Agilent

website, 50

selecting the

wideband/narrowband path,

245, 275

set up the wideband IF, 241, 272

signal envelope view

signal envelope window, 284

signal envelope window, 282, 283

amplitude Y scale, 284

reference position, 284

reference value, 284

scale coupling, 284

scale per division, 284

single vs. continuous

measurement mode, 370

slot type

active slot, 226

idle slot, 226

softkeys, 148

span

CHPower, 446

intermodulation, 460

selecting IF path, 245, 275

- SPECTrum, 542
- span C scale
  - scale coupling, 231
- Span key
  - spectrum measurement, 241
- span X scale
  - reference position, 203, 218, 231
  - reference value, 203, 218, 231
  - scale coupling, 203, 218
  - scale per division, 203, 218, 224, 231
- SPECTrum
  - acquisition packing, 531
  - ADC range, 532
  - data decimation, 538
  - FFT length, 539
  - FFT resolution BW, 540
  - FFT window, 541
  - FFT window delay, 540
  - frequency span, 542
  - sweep time, 542, 543
  - trigger source, 543
- spectrum
  - all traces, 254, 282
  - averaged trace, 254, 282
  - changing views, 120, 250
  - current trace, 254, 282
  - I signal trace, 254, 282
  - next window selection, 250
  - Q signal trace, 254, 282
  - span X scale, 254
  - trace display, 254, 282
  - view/trace, 120, 250
  - zoom a window, 250
- Spectrum (Frequency Domain)
  - key, 241, 603
- spectrum (frequency domain)
  - measurement, 414, 531
- See also SPECTrum
- spectrum emission mask
  - detector mode, 496
  - measurement interval, 528
  - offset frequencies, 498, 515
  - offset frequencies auto mode, 499, 500, 516
  - offset start frequency, 501, 516
  - offset stop frequency, 502, 504, 517, 519
  - offset stop frequency auto mode, 503, 518
  - power reference, 529
  - relative attenuation, 504, 519
  - setting amplitude levels, 506, 508, 509, 511, 513, 520, 521, 523, 524, 525, 526
  - testing choices, 509, 522
  - trigger source, 529
- spectrum emission mask
  - measurement, 408, 493
- See also SEM
- spectrum measurement
  - basic mode, 141
  - method, 603
  - results, 119, 250
- spectrum measurement display, 356, 357, 364, 365
- spectrum phase
  - CDPower, 443
- spectrum segment, 269
  - offset, 266
    - all offsets, 266
    - offset A, 267
    - offset E, 267
    - offset side, 267
  - offset or region, 260
  - region, 267
    - all regions, 267
    - region A, 268
    - region E, 268
  - regions and limits, 263
- spectrum emission mask, 527, 528
- spectrum type
  - RHO, 491
- spurious emissions and ACP
  - measurement setup, 257
  - view/trace, 266
- spurious emissions and ACP
  - measurement, 493
- spurious emissions or ACP
  - marker menu, 270
  - delta reading, 270
  - erase a marker, 270
  - erase all markers, 270
  - function selection, 270
  - marker shape, 270
  - normal reading, 270
  - trace selection, 270
- standard deviation of trace data, 296, 303
- start measurement, 370, 371
- state
  - changing, 439
- store reference
  - power statistic CCDF, 324
- sweep time
  - SPECTrum, 542, 543
  - WAVEform, 575
- Sweep Time key, 271
- symbol power graph
  - amplitude Y scale
    - reference position, 184
    - reference value, 183
    - scale coupling, 184
  - scale per division, 183
  - display, 182
    - composite chip power, 182
    - I/Q Combined Power Bar, 182
  - span X scale
    - reference position, 170, 183
    - reference value, 183
    - scale coupling, 183
    - scale per division, 183
  - sync start slot key, 174, 209

## T

## TCDFP

- computation type, 329
- Walsh code order, 330
- terminal code domain error limit
  - 1xEV-DO, 338
- Terminal code domain
  - measurement, 545
- terminal code domain
  - measurement
    - ADC range, 550
- terminal code domain power
  - measurement, 417
- terminal modulation accuracy
  - frequency error limit test, 339
- terminal modulation accuracy
  - (rho)
    - ACK channel power gain, 338
    - active code domain power tolerance, 338
    - active set threshold, 337
    - active set threshold mode, 337
    - code domain error limit, 338
    - data channel power gain, 339
    - DRC channel power gain, 339
    - inactive channel power limit, 339
    - peak EVM limit, 341
    - pilot time offset limit, 341
    - rho limit, 341
    - rho result I/Q offset, 337
    - RMS EVM limit, 342
    - RRI limit, 342
- Terminal modulation accuracy
  - measurement, 556
- terminal modulation accuracy
  - measurement, 426
    - ACK channel definition, 559
    - ADC range, 560
- test limit
  - OBW, 322
- test limits, 296
  - cdmaOne, 331, 332
  - EVM, 331, 332
- tile the display, 353
- time averaging, 244, 274

- time domain measurement, 436, 569
  - time domain measurements, 271, 606
  - time offset limit
    - cdma2000, 334
    - modulation accuracy (rho), 334
  - time reference
    - burst center, 228
    - burst rise, 228
    - trigger, 228
  - timing estimation
    - code domain measurement, 211
  - trace averaging, 464
  - trace data
    - processing, 296, 303
  - trace display, 359
  - trace format, 368
  - trace names for markers, 311
  - trace/view selection
    - magnitude & phase graph view, 136, 279
  - transmit band spurs - averaging state, 571
  - trigger, 154
    - auto time, 577
    - automatic trigger, 155
    - burst level, 582
    - commands, 577
    - delay, 154, 578
    - delay, IF, 581
    - external, 578, 579
    - external front input, 154
    - external rear input, 154
    - frame adjustment, 579, 580
    - frame period, 579
    - frame sync mode, 580
    - frame timer, 155
      - offset, 155
      - period, 155
      - reset offset display, 155
      - synchronizing source, 155
    - holdoff, 581
    - level, 154, 578
    - level, IF, 581
    - on/off, 577
    - power vs. time, 484
    - RF burst signal, 154
    - slope, 154, 579
    - slope, IF, 582
    - SPECTrum, 543
    - timeout, 577
    - trigger holdoff, 154
    - trigger source, 244, 274
      - external front input, 244, 275
      - external rear input, 245, 275
      - frame clock, 245, 275
      - free run (immediate), 244, 274
      - line, 245, 275
      - RF burst (wideband), 244, 274
      - video (IF envelope), 244, 274
      - video (envelope) signal, 154
      - WAVEform, 575
  - trigger measurement, 370, 371
  - trigger source
    - cdma2000, 444
    - OBW, 465
    - QPSK EVM, 454
    - Rho, 492
    - spectrum emission mask, 529
    - W-CDMA, 444
  - triggering
    - CHPower, 448
  - triggering setup help, waveform measurement, 140
- ## U
- Uninstall Now, 49, 50
  - uninstalling measurement
    - personalities, 43
  - upper mask
    - level and on/off, 227
- ## V
- view code domain data, 353
  - view commands, 353
  - view PVT data, 354, 355
  - view rh data, 355
  - view/trace
    - I/Q error with quad view, 215
    - I/Q measured polar graph, 214
    - I/Q waveforms, 122, 251
    - linear spectrum and phase graphs, 121, 251
    - peak/avg metrics, 214
    - spectrum graph, 120, 250
  - view/trace menu
    - I/Q error with quad view, 198, 237
    - I/Q measured polar
      - constellation view, 236
    - I/Q measured polar graph, 197
    - I/Q measured polar vector view, 235
    - I/Q measured with quad view, 200
    - I/Q polar and power graph, 169
    - power graph and metrics, 167
    - power, timing, and phase results, 201
    - result metrics view, 198
  - view/trace selection
    - I and Q Waveform view, 281
    - I and Q waveform view, 255
    - I/Q polar waveform view, 137, 281
    - I/Q waveform graph window, 120, 250
    - I/Q Waveform view, 136, 280
    - linear envelope and phase view, 279
    - region A through E, 230
    - rising and falling edge regions, 230
    - Spectrum I/Q Waveform view, 120, 250
    - spectrum linear
      - linear spectrum window, 254, 255
    - viewing the time domain, 140
    - VSA versus PSA series (programming compatibility), 294
- ## W
- WAVEform
    - acquisition packing, 569
    - ADC dithering, 569
    - ADC filter, 569
    - ADC range, 570
    - data decimation, 574, 575
    - sweep time, 575
    - trigger source, 575
  - waveform
    - changing displays, 282
    - I/Q waveform view, 285
    - linear envelope view, 285
    - method, 606
    - resolution bandwidth, 271
    - results, 135
    - span X scale, 282
    - sweep time, 282
    - using markers, 286
  - Waveform (Time Domain) key, 606
  - Waveform (Time Domain) Key Menus, 271
  - waveform (time domain)
    - measurement, 436, 569
    - See also WAVEform
    - waveform measurement, 140, 271
      - basic mode, 141
      - display, 286
      - I/Q Polar view, 283, 286
      - results, 134
  - WB ADC Dither key, 242, 273
  - W-CDMA
    - trigger source, 492
  - W-CDMA (3GPP)
    - averaging, 451, 452

offset frequencies, [498](#), [514](#),  
[515](#), [526](#)  
offset frequencies auto mode,  
[499](#), [500](#), [516](#)  
spectrum emission mask  
  measurement, [506](#), [508](#),  
  [509](#), [511](#), [513](#), [520](#), [521](#),  
  [523](#), [524](#), [525](#), [526](#)  
  trigger source, [454](#), [529](#)  
W-CDMA (3GPP) measurement,  
  [380](#), [388](#), [391](#), [394](#), [395](#), [401](#),  
  [408](#), [450](#), [456](#), [462](#), [469](#), [493](#)  
W-CDMA (Trial & ARIB)  
  averaging, [451](#), [452](#)  
  trigger source, [454](#)  
W-CDMA (Trial & ARIB)  
  measurement, [380](#), [388](#), [395](#),  
  [401](#), [450](#), [469](#)  
Wideband Advanced key, [241](#),  
  [272](#)  
wideband filter alpha, [241](#), [272](#)  
wideband filter bandwidth, [241](#),  
  [272](#)  
wideband filter type, [272](#)  
Wideband Filtering key, [241](#), [272](#)  
wideband IF  
  advanced settings, [242](#), [272](#),  
  [273](#)  
wideband IF data block size, [272](#)  
wideband IF data sample rate,  
  [272](#)  
wideband IF filter type, [241](#)  
Wideband IF Gain key, [241](#), [272](#)  
Wideband IF Setup key, [241](#), [272](#)  
wideband path selection, [245](#), [275](#)  
Window Length key, [242](#), [246](#)

## Z

zero span measurement, [436](#), [569](#)  
zoom the display, [354](#)